

# SYSTEMWIDE BASELINE CHANGE NOTICE (SBCN)

DOCUMENT/TITLE/NUMBER/REVISION:

Update Design Criteria Section 9.3 – Rail Vehicle Interface

**CHANGE IMPACT ASSESSMENT SUMMARY:** (Attach written explanation of impacts identified)

SCHEDULE ISSUES?:	N	OTHER DOCUMENT REVISIONS REQUIRED?:	
ROM (RANGE):	<b>NO COST</b>	DESIGN ISSUES?:	N
TIME IMPACT:	N/A	SAFETY ISSUES?:	N
CAL DAYS	N/A	THIRD PARTY?:	N
		COST RECOVERY POTENTIAL:	N
		OTHER CONTRACTS/PROJECTS?:	N/A

**Related Request(s)-For-Change:** NONE

**JUSTIFICATION (including benefit or impact if not pursued):**

This is an advanced SBCN issued under the Executive Officer, Engineering signature for inclusion in upcoming RFPs (inclusion in Contract C0980 Regional Connector RFP and Contract C1045 Purple Line Extension RFP). Although reviewed extensively by the interested parties, formal review and approval process will follow.

Revisions are as follows:


1. Revised the section title to "Rail Vehicle Interface" to provide definition of existing vehicles to assist in design of fixed facilities.
2. Revised section 9.3.2 to include vehicle characteristics for existing LRV (P2000, P2550, P865/P2020, P3010) and HRV (A650) fleet, including the following:
  - Car Body Basic Dimensions
  - Truck Basic Dimensions
  - Vehicle Maximum Weights
  - Jacking Pad / Lifting Point Locations
  - Regenerative Braking Current Limits
  - Wheel Profiles
3. Revised section 9.3.1 Communications to specify 4-hr. battery backup power, 4 Intercoms/vehicle, and vehicle data (DVR & diagnostics) transmission via 802.11 type of wireless technologies.
4. Removed subsections I. Vehicle Doors, J. Windows, K. Interior Features, M. Cab Controls/Indicators, N. Signaling, P. Braking, Q. Auxiliary Electrical, R. Other Design Features, S. Internal Climate Control, T. Air Comfort System, U. Lighting, V. Ride Quality, W. Noise, X. Climate, and Y. Lighting.

**PROJECTS/CONTRACTS AFFECTED: For new projects only**

PROJ CONTRACT CN #	ACTION STATUS
-----	

TOTAL ESTIMATED CHANGE COST: (DIRECT)
TOTAL ESTIMATED CHANGE COST: (INDIRECT: POTENTIAL COST RECOVERY)
TOTAL ESTIMATED CHANGE COST: (INDIRECT+ DIRECT)

**RECOMMENDATION AND APPROVAL SIGNATURES:** (R = RECOMMEND, A = APPROVE)

RTG	APPROVAL	NAME/TITLE	SIGNATURE	DATE
R	DIRECTOR CONFIGURATION MANAGEMENT	D. CURZON		
R	DIRECTOR PROJ. ENG. FACILITIES	A. DAVIDIAN		
R	DIRECTOR PROJ. ENG. SYSTEMS	M. RATNASINGHAM		
R	INTERIM EXECUTIVE DIRECTOR, RAIL OPERATIONS	B. SHELBURNE		
R	DIRECTOR QUALITY MANAGEMENT	W. MOORE		
R	EO, PROJECT ENGINEERING	S. MAYMAN		06/27/13
A	EXECUTIVE DIRECTOR TRANSIT PROJECT DELIVERY	K.N. MURTHY		
A	IMPACTED PROJECT MANAGER – N/A			

**METRO RAIL DESIGN CRITERIA**

**SECTION 9**

**SYSTEMS**

**TABLE OF CONTENTS**

	<u>PAGE</u>
<b>SYSTEMS</b>	
<b>9.1 GENERAL REQUIREMENTS FOR SYSTEMS.....</b>	<b>1</b>
9.1.1 Applicable Documents .....	1
9.1.2 Legal Requirements.....	1
9.1.3 Standards .....	1
<b>9.2 FARE COLLECTION .....</b>	<b>2</b>
9.2.1 Description – Concept of Operations.....	2
9.2.2 Functional Requirements.....	2
9.2.3 System Interfaces .....	8
9.2.4 Revenue Servicing and Equipment Maintenance .....	8
9.2.5 Station Design .....	9
9.2.6 Sizing Methodology .....	16
9.2.7 Security Monitoring .....	20
9.2.8 UFS Communications .....	20
<b>9.3 RAIL VEHICLE INTERFACE.....</b>	<b>23</b>
9.3.1 Introduction .....	23
9.3.2 Vehicle Characteristics .....	23
<b>9.4 TRAIN CONTROL .....</b>	<b>52</b>
9.4.1 Description.....	52
9.4.2 Metro Gold Line Expansion and Any New Construction .....	55
9.4.3 Metro Blue Line Expansion.....	68
9.4.4 Metro Green Line Expansion .....	82
9.4.5 Metro Red Line Expansion and Any New HRT Construction.....	93
9.4.6 Yard train control system .....	107
<b>9.5 COMMUNICATIONS - GENERAL.....</b>	<b>114</b>
9.5.1 Introduction .....	114
9.5.2 General Design Criteria .....	117
9.5.3 Tunnel Conduit/Tray Routing.....	123
9.5.4 Communications Power System.....	124
<b>9.6 RADIO SYSTEM.....</b>	<b>124</b>
9.6.1 General.....	124
9.6.2 Underground and Tunnel Radio Systems.....	126
9.6.3 Above Ground Radio System .....	140
<b>9.7 TELEPHONE SUBSYSTEM.....</b>	<b>142</b>
9.7.1 General.....	142
9.7.2 IP Telephony System.....	142
9.7.3 Administrative Telephone (ATEL).....	143
9.7.4 Emergency Telephone (ETEL) .....	143
9.7.5 Passenger Assistance Telephone (PTEL).....	144
9.7.6 Maintenance Telephone (MTEL) .....	144
9.7.7 Installation and Number of Telephones .....	145

9.7.8 Public Telephone Service ..... 145

**9.8 TRANSIT PASSENGER INFORMATION SYSTEM (TPIS)..... 145**

9.8.1 Public Address ..... 145

9.8.2 Visual Message Signs ..... 150

9.8.3 Transit Passenger Information System Automatic Announcements..... 153

**9.9 CLOSED-CIRCUIT TELEVISION ..... 154**

9.9.1 Functional Requirements ..... 154

9.9.2 Design Criteria ..... 155

9.9.3 Operation: Continuous Duty ..... 160

9.9.4 Triggers/Video Analytics (Analytical Video Systems – AVS) ..... 160

**9.10 CABLE TRANSMISSION SYSTEM (CTS)..... 161**

9.10.1 General ..... 161

9.10.2 Design Criteria ..... 162

**9.11 SUPERVISORY CONTROL AND DATA ACQUISITION ..... 163**

9.11.1 General ..... 163

9.11.2. Functional Requirements ..... 164

9.11.3. Design Criteria ..... 165

**9.12 FACILITY AND EMERGENCY MANAGEMENT SYSTEM ..... 166**

9.12.1 General ..... 166

9.12.2 Operation ..... 167

9.12.3 Design Criteria ..... 168

**9.13 INTRUSION DETECTION AND CONTROLLED ACCESS ..... 169**

9.13.1 General ..... 169

9.13.2 Design Criteria for Ancillary Space ..... 170

9.13.3 Design Criteria for Open Space (Right of Way) ..... 173

**9.14 FIRE ALARM SYSTEM ..... 174**

9.14.1 General ..... 174

9.14.2 Design of the Fire Alarm System ..... 174

9.14.3 Device Placement ..... 176

9.14.4 Power ..... 177

9.14.5 Central Supervisory Station ..... 177

**9.15 GAS MONITORING AND SEISMIC ACTIVITY DETECTION ..... 177**

9.15.1 Gas Monitoring Equipment ..... 177

9.15.2 Seismic Detection Equipment ..... 178

**9.16 CENTRAL CONTROL APPARATUS..... 179**

9.16.1 General ..... 179

9.16.2 Controller and CCTV Observer Consoles..... 179

9.16.3 Voice Recording ..... 179

9.16.4 Printers ..... 179

9.16.5 System Status Display Subsystem ..... 179

9.16.6 CCTV Wall Area ..... 180

9.16.7 Data Processing Room ..... 180

9.16.8 Communications Equipment Room ..... 180

9.16.9 Battery Room..... 180

9.16.10 Yard Control Tower Equipment ..... 180

**9.17 YARD COMMUNICATIONS ..... 181**

9.17.1 General ..... 181

9.17.2 Communications Equipment Room ..... 181

9.17.3 Cable Transmission System (CTS)..... 181

9.17.4 Telephone Service ..... 181

9.17.5 Public Address ..... 181

9.17.6 SCADA ..... 182

9.17.7 Intrusion Detection..... 182

9.17.8 Fire Detection and Suppression Monitoring..... 182

9.17.9 Closed Circuit Television (CCTV) ..... 182

**9.18 TRACTION POWER AND DISTRIBUTION SYSTEM ..... 182**

9.18.1 General ..... 182

9.18.2 Scope..... 183

9.18.3 Codes and Standards ..... 183

9.18.4 Equipment Standardization..... 184

9.18.5 Traction Power Substations ..... 184

9.18.6 Sectionalization, and Emergency Trip System-ETS ..... 189

9.18.7 Trainway Feeder and Emergency Back-up Power Supply ..... 190

9.18.8 Wayside Distribution ..... 191

**9.19 Cyber Security for Rail Communication Networks/ Control Systems..... 202**

9.19.1 Overview ..... 202

9.19.2 Network Design ..... 202

9.19.3 Cyber / Network Security Configuration, Data and Documentation ..... 204

9.19.4 Account / Password Management and Documentation ..... 204

9.19.5 Virus / Malware Protection ..... 204

**TABLES**

<u>Section</u>	<u>Table Number</u>	<u>Title</u>
9.3.2	9.1	Braking Rates for Light Rail Vehicles
N/A	9.2	Not Used
9.3.2	9.3.1	Light Rail and Heavy Rail Carbody Basic Dimensions
9.3.2	9.3.2	Light Rail and Heavy Rail Trucks Basic Dimensions
9.3.2	9.3.3	Light Rail and Heavy Rail Maximum Weights
9.3.2	9.3.4.a	Light Rail Vehicle Jacking Pad Locations
9.3.2	9.3.4.b	Heavy Rail Vehicle Jacking Pad Locations
9.3.2	9.3.5	Braking Rates for Light Rail Vehicle
9.6.2.B	9.6.1	Repeater Radio Specifications for 160 MHz Frequency Band
9.6.2.B	9.6.2	Repeater Radio Specifications for 450/460 MHz Frequency Band
9.6.2.B	9.6.3	Channelized Repeater Amplifier Specifications
9.8.1	9.8.1	Input Priorities
9.9.2	9.9.1	Approximate Focal length needed for a 3 wide Field of view

## FIGURES

<u>Section</u>	<u>Figure Number</u>	<u>Title</u>
<del>9.3.2</del>	<del>9.1</del>	<del>Light Rail Vehicle Dimensions and Design Loading</del>
<b>9.3.2</b>	<b>9.3.1.a</b>	<b>Light Rail Vehicle</b>
<b>9.3.2</b>	<b>9.3.1.b</b>	<b>Heavy Rail Vehicle</b>
<b>9.3.2</b>	<b>9.3.2.a</b>	<b>Light Rail Vehicle Jacking Pad Locations</b>
<b>9.3.2</b>	<b>9.3.2.b</b>	<b>Heavy Rail Vehicle Jacking Pad Locations</b>
<b>9.3.2</b>	<b>9.3.3.a</b>	<b>Resco Wheel Profile Ansaldo-Breda A650</b>
<b>9.3.2</b>	<b>9.3.3.b</b>	<b>RTD-1 Wheel Profile Siemens P2000</b>
<b>9.3.2</b>	<b>9.3.3.c</b>	<b>RTD-1 Wheel Profile Ansaldo-Breda P2550</b>
<b>9.3.2</b>	<b>9.3.3.d</b>	<b>RTD-1 Wheel Profile Nippon-Sharyo P865/P2020</b>
<b>9.3.2</b>	<b>9.3.3.e</b>	<b>RTD-1 Wheel Profile Kinki-Sharyo P3010</b>
9.5.2.C	9.5.1	Equipment Grounding
9.6.2.A	9.6.1	Underground Radio System Block Diagram
9.8.2	9.8.1	Character and Number Height Versus Viewing Distance
9.8.2	9.8.2	Typical Overhead Signage

**Appendix A – Remote Terminal Unit**

**Appendix B – SCADA RTU Interface Requirements**

**Appendix C – The Format for Radio Power Budget Analysis**

## SYSTEMS

### 9.1 GENERAL REQUIREMENTS FOR SYSTEMS

#### 9.1.1 *Applicable Documents*

The codes of Los Angeles City and County and the State of California shall prevail where applicable. Where no City, County, or State codes exist, the standards of the following regulatory and advisory agencies shall be followed:

- American National Standards Institute (ANSI)
- American Society of Mechanical Engineers (ASME)
- American Society of Testing and Materials (ASTM)
- Electronic Industries Association (EIA)
- Federal Communications Commission (FCC)
- Insulated Cable Engineers Association (ICEA)
- Institute of Electrical and Electronics Engineers (IEEE)
- California Code of Regulations (CCR), Title 19, State Fire Marshal
- National Electrical Manufacturers Association (NEMA)
- National Fire Protection Association (NFPA)
- California Code of Regulations (CCR), Title 8, Health and Safety Act
- California Public Utilities Commission (CPUC)
- Underwriters Laboratory (UL)
- U. S. Department of Transportation (DOT/FTA)
- California Building Code, Title 24, Uniform Building Code.
- United States "Americans with Disabilities Act (ADA) of 1990.

#### 9.1.2 *Legal Requirements*

The Communications system equipment and apparatus shall comply with legal requirements set forth in the following documents:

- Federal Communications Commission, Part 1, "Practices and procedures;" Part 2, "Frequency Allocations and Radio Treaty Matters;" part 15, "Radio Frequency Devices;" Part 17, "Construction, Marking, and Lighting of Antenna Structures;" Part 68, "Connection of Terminal Equipment to Telephone Equipment;" Part 90, "Private Land Mobile Radio Services."
- California Public Utilities Commission, General Order No. 95, "Rules for Overhead Electric Line Construction;" General Order No. 128, "Construction of Underground Electric Supply and Communications Systems."

#### 9.1.3 *Standards*

In addition to the standards of Paragraph 9.1.1 the Communications system design and equipment shall be specified and constructed in accordance with the criteria herein.

- American Railway Engineering and Maintenance of Way Association (AREMA)
- American Public Transit Association (APTA)
- American Standard Code for Information Interchange (ASCII)
- Factory Mutual System (FMS)
- U.S. Government Code of Federal Regulations and Military Standards
- Metro Fall Protection Policy
- Metro Fire/Life Safety Criteria

## 9.2 FARE COLLECTION

### 9.2.1 *Description – Concept of Operations*

The purpose of these criteria is to describe the Fare Collection System and compatible equipment to be used with Metro Rail Transit facilities with exclusive guideways. The fare collection system utilizes both Barrier and Barrier-Free configurations.

The Barrier configuration shall be provided on all grade separated stations (elevated and underground), and be evaluated for use at at-grade stations where practical. The Barrier configuration utilizes Ticket Vending Machines (TVMs) at station entrances and requires patrons to use a properly encoded POP (Proof of payment) document, “smart card”, to access the paid area of a station through fare gates.

The Barrier-Free configuration shall be provided on at-grade stations (exclusive right-of-way or in-street) where determined that use of the Barrier configuration is impractical. The Barrier-Free configuration utilizes TVMs at station entrances but requires patrons to validate a properly encoded smart card at a Stand-Alone Validator (SAV) to access the paid area of a station without passing through a fare barrier. The Barrier-Free configuration operates on the “Proof of Payment” (POP) principle – passengers will purchase their fares off-board before entering a designated paid area of the station.

Once on the paid area of the station or on the vehicle, regardless of whether the patron entered through a barrier or barrier-free station entrance, they must have in their possession a POP document (which is defined broadly to include printed or electronic documents such as a properly encoded smart card or magnetic stripe card) that can be checked by inspectors. If the passenger does not have such a POP document, they may be cited under applicable statutes.

The fare collection system will enable patrons to purchase the POP without human intervention. The system elements shall be compliant with the Universal Fare System (UFS) procured by Metro beginning in 2001.

In addition to the equipment and apparatus designed to serve and assist the Metro System patrons, the fare collection equipment shall include auditing and monitoring equipment, revenue handling and transporting equipment, and data processing equipment.

### 9.2.2 *Functional Requirements*

The main components of the Fare Collection System shall respond to functional requirements inherent to their respective service functions. The functional requirements of the main components shall be the following:

#### A. General



The following general requirements shall apply to all station-installed equipment of the fare collection System:

The Fare Collection system shall be designed to be compatible with Metro Rail station design.

The number and types of equipment at each station shall be based on:

- Ridership analysis at each Metro Rail station; specifically peak demand.
- Fare policy to be utilized (the Barrier-Free configuration or the Barrier configuration).
- Metro policy on maximum allowed queue length (passenger waiting plus transaction time; for TVM 2 minutes, for SAV 20 seconds) for fare transactions. The average time of a transaction (time between arrival at the fare equipment queue and the completion of transaction) shall not exceed 120 seconds.
- Transaction times for fare collection equipment.
- The provisions (raceways, power availability, etc.) shall be implemented for Maximum Line Capacity requirements or the maximum ridership that can be carried on new line.
- Metro policy on queuing length for fare gates.

The Fare Collection policy is to have a minimum of two ticket vending machines (TVMs) at each fare vending area, with additional numbers to be based on ridership analyses. The provisions (raceways, etc.) shall be implemented for Maximum Line Capacity requirement adjusted per minimum policy. Stations or platforms with multiple entrances in the same direction shall have a minimum of one ticket vending machine at each entrance. Platforms with more than one entrance in the same direction will be considered individually, and equipment will be allocated to entrances based on ridership projections for that entrance. At non-gated stations, a minimum of two Stand Alone Validators (SAVs) to validate pre-paid fare media shall be located at each entrance to the station platform. However the provisions (raceways, etc.) shall be implemented for Maximum Line Capacity requirement adjusted per minimum policy, or virtual gate arrangement, whichever is larger.

All equipment shall comply with the functional requirements embodied in Metro's specification for the Universal Fare System.

#### B. Ticket Vending Machines (TVM)

Fares shall be sold at Ticket Vending Machines (TVM). These shall be capable of selling single ride tickets and other fare types, and loading stored-value media (e.g., smart cards).

TVMs shall be located at or near the entrance to each "paid" area. A reduced function TVM may be provided in some locations. Such a device may accept only credit/debit card payment (no cash), and may have limited fare types available.

Ticket Vending Machines shall comply with the requirements of Metro's Universal Fare System. Capabilities shall include the following:

**1. General Characteristics:**

- Ergonomic external design similar to existing equipment.
- Designed to withstand vandalism and prevent minimum entry of liquids while providing maximum ease of use for entry of coins and bills.
- Exterior light and lighting system
- Patron display unit that provides input and assistance to the patron during transactions.
- Expandability, using open ports or circuit card slots for future capability to process other payment media

**2. Security**

- Strengthened stainless steel cabinet
- Audible intrusion and vibration alarms
- Maintain and print a record of alarms
- Alarms reported to the Central Data Collection System (CDCS) and Metro SCADA system in real time
- High security locking mechanism.
- Separate secure vaults to contain coins and bills

**3. Customer Interface**

- Menu driven display screen with customer information
- Comply with requirements of the Code of Federal Regulations, 28 CFR Part 36, "Nondiscrimination on the Basis of Disability by Public Accommodations and in Commercial Facilities" and Title 24 California Building & Standards Code (Physical Access Regulations).
- Support multiple languages

**4. Ticketing**

- Ability to handle multiple ridership categories
- Means of easily changing ticket print format and generating additional ticket types as required, through the Central Data Collection System (CDCS)
- Ticket (until conversion to issuance of smart cards) and receipt printing using thermal printing
- Provide fare validation functions(until conversion to issuance of smart cards), similar to those of the SAV (see C [belowbelow](#))
- Self-unjamming for the coin system and bill note acceptor
- Payment Processing
- Accept US coins and currency in common circulation
- Accept, smart cards, tokens, credit cards and debit cards
- Recirculation of coins for use as change
- Continuous monitoring of ticket (or smart card) stock, coins and bills
- Multiple bills escrowed pending completion of transactions.

**5. Credit/ATM (Debit) Bank Card System**

- Capable of processing credit and debit card transactions, in accordance with prevailing banking regulations.
- System to be provided shall include interface capabilities for regional transaction processing system as defined by Metro.
- Minimizing fraud by comparing credit and debit card numbers against internal bad-card lists, updated regularly.
- Checking sales against editable parameters
- Routing transactions to the clearing house, checking customer personal identification number (PIN) (debit card payments only), obtaining authorization and transmitting the authorization to TVMs.
- Providing Settlement data to Metro and the clearinghouse.
- Exterior lighting and lighting system.

#### **6. Contactless Smart Card Processor**

- Compliant with UFS standard for contactless smart cards
- Add value or time, validate (deduct rides or value), and perform all other functions on contactless smart cards, consistent with current contactless smart card functionality adopted by Metro.
- Capability to provide Metro personnel access authorization via a smart card for revenue servicing and maintenance.
- Ability to handle multiple ridership categories
- Means of easily changing ticket product format and generating additional ticket types as required, through the Central Data Collection System (CDCS)

#### **7. Contact Smart Card Reader**

- EMV compliant
- Read identification and security data from and remove and load to or remove value from "electronic purse" on contact-type smart card.
- Capability to provide Metro personnel access authorization via a smart card for revenue servicing and maintenance.
- Track travel behavior
- Cancel lost or stolen cards
- Provide ancillary revenue operations

#### **8. Reporting**

- Report all transactions in batch mode via Data Transmission System
- Fully transactional database
- Alarms and credit/debit card transactions reported in real time
- All additions must be fully compliant with the existing Universal Fare System in place.

#### **C. Stand Alone Validator**

In a POP system using stored-value or stored-ride fare media, it is necessary for patrons to "validate" their fare media prior to entering the paid area. In doing so, they obtain either a printed ticket (until conversion to issuance of smart cards) to present

to fare inspectors, or their electronic fare media is encoded to indicate that the fare has been properly deducted. This function may be performed at the TVM (until conversion to issuance of smart cards) or at a Stand Alone Validator (SAV), a small specialized machine designed for this purpose.

Validation capability is also included in TVMs for time until they are converted to issue smart cards. SAVs are to be provided at stations to initially supplement TVMs for this purpose. Additional SAVs may need to be provided following conversion of TVMs to issuance of Smart Cards. At least two SAVs will be provided with the TVMs within non-paid areas for each platform at non-gated stations. Additional combinations of TVMs and SAVs may be provided where additional entrances to specific platforms require this, or where calculations based on ridership warrant it.

Stand Alone Validators provide the following functionality:

- Validate smart cards by deducting the designated fare amount and encoding the new value, with appropriate identifying information.
- Confirm validation of a contactless smart card electronic purse (programmable function) and transmit date, time, location, and SAV identification number to be stored on the smart card.
- Record all validations and transmit all data transactions and event data to the CDCS.
- Be stand-alone devices.
- Support eventual TAP In/TAP Out fare policy.
- Customer interface complying with requirements of Code of Federal Regulations, 28 CFR Part 36, "Nondiscrimination on the Basis of Disability by Public Accommodations and in Commercial Facilities" and Title 24 California Building & Standards Code (Physical Access Regulations).

#### D. Fare Gates

Fare gates will provide similar functionality as stated for SAVs, but will require patrons to tap a properly encoded smart card to open the fare gate barrier to allow the patron to pass through to access the paid area. Fare gates will also be required to be able to be tapped for exit to the non-paid area, when this function is activated.

Where a station design allows for installation of fare gates, they shall be located at or near the entrance to each "paid" area as part of a fare barrier. The fare barrier shall also include emergency swing gates to support emergency egress and fencing to provide complete physical separation between paid and non-paid areas.

Fare gates shall include both the turnstile and barrier-leaf (for ADAAG) types, and along with emergency swing gates, comply with the requirements of Metro's Universal Fare System. Capabilities shall include the following:

All station designs considered for implementation of fare gating shall have queuing analysis/modeling and exit calculations performed to determine feasibility in station design (Reference Section 9.2.6.B below). Where not feasible, station designs shall utilize Stand-Alone Validators (SAVs) in lieu of faregates, with SAVs placed in the Virtual Gate arrangement at or near entrances to platform boarding areas.

#### E. Passenger Assistance Telephones

Passenger assistance telephones shall be provided adjacent to the TVMs (but not on the TVMs) to enable patrons to have voice contact with the Rail Operations Control (ROC) for assistance. These telephones shall be provided within the front field of view of the closed circuit television system of the customer while using this phone.

Provisions shall be made to allow the hearing and speech impaired to indicate a request for assistance. Additional provisions are described in Section 9.7 (Telephone Subsystem).

#### F. Gate Telephones

Gate telephones (GTEs) shall be provided on both sides of fare barriers at gated stations to enable patrons to obtain Metro assistance from personnel remotely monitoring station fare gate arrays. As a minimum, two phones, one phone on each side of the gate array, are required per fare gate array location. The provisions shall be implemented to install future phones along the gate arrays

#### G. CCTV

CCTV cameras shall be provided in stations for monitoring of PTEs, TVMs, SAVs, fare barriers and GTEs (both sides of barrier) to Metro personnel at ROC.

#### H. Data Acquisition

A Central Data Collection System (CDCS) control shall be capable of integrating all (existing and new) fare collection equipment to obtain and process information such as number and type of transaction, revenue collected, and to diagnose malfunctions. The data processor shall be capable of acquiring, processing and storing transaction information from all fare collection equipment for auditing, collecting statistics, and other purposes, as necessary.

#### I. Revenue Transfer

A revenue cart shall be used to replenish change storage units and ticket stock in TVMs and to transfer cashboxes and bill vaults from TVMs to the Revenue Processing Facility (RPF). Carts will be transported from stations to the RPF by revenue truck. The cart and TVM shall provide secure currency transfer and preclude the unauthorized access to revenue funds.

#### J. Enforcement/Security

The free and paid areas of all stations and interiors of all passenger vehicles shall be identified with the following minimum requirements:

- Station entry and platform areas shall have signage that indicates the need for possession of a valid ticket or smart card as Proof of Payment for entry into the paid area. These signs shall be located before and at the point of differentiation, and within the paid areas so as to meet all legislative/legal requirements for effective enforcement.

- Signs shall be conspicuous and easily understood by patrons and comply with legal requirements for such signage.
- The location of the free to paid area line shall be clearly delineated by architectural features or signage to permit easy identification.
- The interior of each vehicle shall have signs that indicate that on-board patrons must possess a valid ticket or smart card. These signs shall comply with all legislative/legal requirements for effective enforcement and be conspicuous and easily understood.
- Refer to Metro Signage Standards.

Fare Enforcement personnel shall be easily identified, assigned adequate enforcement authority, and meet state/local statutes or requirements. Fare enforcement personnel may carry hand-held validators (HHV) or specially programmed mobile phones that will interface to smart cards and indicate whether the card is carrying an electronic proof of payment.

Fare Enforcement personnel may be provided with vehicles – security personnel will normally have vehicles. Parking shall be provided for at least one security/Fare Enforcement vehicle at each station.

### **9.2.3 System Interfaces**

Fare Collection equipment shall be designed to interface with other elements within Metro Rail Stations and throughout the Metro Rail system, as follows:

- Communication Systems
- SCADA System
- Rail Operations Control
- Auxiliary Vehicles
- Revenue Processing Facility
- Central Data Collection System (CDCS)
- Fiber Optic System
- Leased phone lines if necessary

In addition, the Fare Collection System shall interface with other elements outside the Metro System, such as business and commercial institutions for off-site vending of passes, discount tickets, and other promotional fare media.

### **9.2.4 Revenue Servicing and Equipment Maintenance**

Fare collection equipment will require revenue servicing (collection of money and replacement of consumable supplies) and normal maintenance. This will be provided by Metro and/or other personnel using trucks.

Station design shall provide parking in reasonable proximity to equipment for such vehicles. If parking is provided on only one side of the right-of-way, a means of crossing from one platform to the other with wheeled carts shall be provided.

Revenue carts as specified by Metro's Revenue Department will be used on Metro Rail facilities with ticket vending machines. The purpose of the revenue carts shall be to transport ticket stock and money between the ticket vending machines located in the stations and the revenue processing facility. The carts will be hand-pushed by revenue collection personnel en-route between station equipment and revenue trucks, and between revenue trucks and the revenue processing facility, and shall be designed to fit on Metro System elevators and revenue trucks.

The revenue cart and station fare collection equipment shall accommodate coin and currency transfer without requiring revenue personnel to handle money at the stations.

### **9.2.5 Station Design**

Communications provisions will need to be included in the station design to accommodate fare collection data communication back to the CDCS, SCADA alarm indications to ROC, and for fare gates, tie in the ROC and EMP Evacuation Message System (EMS) for underground stations, and Fire Control Panel (FCP) for all other stations, as well as other communications requirements such as PA, CCTV, VMS, etc. back to Rail Operations Control (ROC).

A secured communications room/building/enclosure shall be provided at each station and shall be equipped with power, air-conditioning, entrance blocks and backboard as required by the communications systems and local telephone carrier and grounding to support installation of leased phone line and conduit infrastructure and racks to mount communication equipment supporting each system, including station network equipment for fare collection system.

Canopies with lighting should be provided to cover TVM and faregate equipment locations. Lighting shall be configured to illuminate the front of the TVMs without creating glare on the TVM display screen that would make it unreadable. Lighting shall be configured to provide a measure of security for station patrons. For minimum lighting requirement/criteria, refer to Table 7.1 Metro Design Criteria, IES, and ANSI criteria and recommendations.

CCTV coverage shall be provided as required, including the face of TVMs, SAVs and telephones. CCTV shall also be provided to monitor fare gate arrays.

#### **A. Location of Equipment**

Paid and non-paid areas of station platform will be defined for each Metro Rail station. The paid area is considered the entire boarding area or at gated stations beginning on the inside of the fare barrier after entering from a non-paid area.

TVMs and, at non-gated stations, SAVs shall be located in non-paid areas of the station, with SAVs typically located at entrances to the station platform (paid boarding area). The boundary between paid and non-paid areas of the platform shall be marked with signage to indicate requirement for patrons to possess proof of payment before entering the paid area. Other architectural elements (such as floor colors or textures) will be used together with signage to indicate



the separation between paid and non-paid areas. Refer to Metro Signage Standards.

Each station platform shall have a minimum of two TVMs and, at ungated stations, two initially installed SAVs. In cases where there are multiple entrances to a single platform, each station platform entrance shall have a minimum of one TVM and one initially installed SAV as part of a TVM/SAV group or array.

Provisions for additional future TVM and SAV installations beyond the minimum required should be considered based on Maximum Line capacity.

Initial fare gate installation and provisions for same shall be based on Maximum Line Capacity Requirement, modified as necessary by results of queuing modeling analysis and as necessary to comply with NFPA 130 station egress requirements.

Each TVM/SAV group or array shall include provisions for at least four SAVs. SAVs have a higher transaction volume, but require less time for each transaction. SAVs should be located as close as possible to the entrance to the paid area so that passengers pass them as they enter or exit the paid area. SAV positions shall be located across the entrance to the paid area along the line of separation between the paid and non-paid areas, forming a “virtual-gate fare line” analogous to turnstiles in a gated rapid transit system. If the TVMs are some distance from the boundary of the paid area due to layout considerations, the SAV(s) shall be provided at, or as close as possible to, the boundary.

TVM and SAV locations need to allow for sufficient front clear space to comply with ADAAG accessibility regulation front and side wheelchair access requirements. Fare gate locations providing ADAAG access shall comply with ADAAG accessibility regulations.

TVM and SAV locations on non-paid areas of platforms need to be such that equipment is outside of Metro Rail Right-of-Way clearance envelopes to ensure that equipment does not obstruct the path of approaching vehicles and attachments, or obstruct train operator full field of vision at station platform, pedestrian and vehicular grade crossings.

At gated stations, fare gates and associated fencing shall be located to provide queuing spaces and clearances/spacings with other station elements as identified Section 6, Architectural Criteria.

Fare gate aisle widths shall be 20” wide for turnstile aisles and 36” for ADAAG aisles.

At least one ADAAG aisle shall be provided in each faregate array.

Emergency Swing Gates and Fencing used in fare barriers shall be 5 ft. in height above finish surface and be of stainless steel construction for underground stations and painted steel construction for other than underground stations.

TVM locations shall allow for front TVM door swing opening at least 130 degrees, based on door being full width of machine and hinged on the left side of cabinet.



SAV locations shall allow for top cover swing opening at least 130 degrees, based on the angled cover being full width and depth and hinged at the top back side of the cabinet. This shall be considered in locating fare collection equipment near support columns, trash enclosures, and other vertical elements in the station design.

TVM and SAV locations shall account for patron sight distances of trains and vehicles at intersections.

The maximum dimensions of each TVM are 36" wide x 25" deep x 74" high (76.2" to top of fan shroud). The maximum dimensions of each SAV are 14" wide x 7" deep x 43" high. An additional side clearance of 12" minimum, back clearance of 6" minimum, and front clearance of 48" minimum shall be provided for the TVM. SAVs shall be sited with 14" side parallel to patron flow across the paid/non-paid boundary, have a back-to-back clearance of at least 4" and have a minimum front-to-front clearance of at least 48" for ADAAG compliance.

Side clearance is required for patron queuing space, ADAAG clear space, equipment installation, and for opening the doors of the machines for maintenance and service. If TVMs/SAVs are grouped such that two or more machines are side-by-side in a grouping, the external side clearance needed to either external side of the grouping shall be 6" for TVMs and 8" for SAVs. These space requirements shall be taken into account when locating TVMs or SAVs near support columns, trash enclosures, and/or other vertical elements in the station design.

Canopy coverage shall be provided for TVMs and fare gates for protection of equipment when it is opened for maintenance and revenue servicing during inclement weather. This will also provide weather protection for passengers using the equipment.

## B. Basic Provision Requirements

### 1. Equipment Pad – TVMs, Fare Gates and SAVs

TVMs, Fare Gates, and SAVs will be designed for outdoor installation and be freestanding, suitable for mounting to finish surface using anchors at the four corners within the base of each equipment cabinet type.

The minimum concrete slab thickness in area for mounting TVMs, fare gates, and SAVs shall be at least 8" throughout footprint of the device, extending at least 12" beyond the footprint perimeter to allow for drilling and setting anchors. Station platform slopes at equipment location shall be limited to a maximum of 2% transverse and 2.4% longitudinal. The pad surface shall be as level as possible to minimize the gap between equipment bases and finish surface of pad.

TVMs and SAVs will be installed level by fare collection equipment personnel. Fare gate consoles will be installed level side to side and parallel front to back by fare collection equipment personnel. Any resulting gap between TVM, fare gate, or SAV base and the finish mounting surface will be sealed.

## 2. Conduits

For Communications, minimum branch conduit sizes to be run from each device location to nearest communication pull box or junction box located within area of TVM/SAV Group shall be 1" for Telephones, 1" for CCTV cameras, 1" for separate PA zone, two (2) 1" for message boards, 2" for TVMs, 1" for SAVs, 1" for fare gate underfloor duct junction boxes, with minimum 2" size home conduit run for each subsystem continuing to the Communication room or the cabinet for installation of communications and SCADA interface cables.

For Power, minimum 1" size branch conduit shall be run from each message board, TVM/SAV location and from each fare gate underfloor duct junction box to nearest power pull box, with continuation conduit of appropriate size (per NEC) for wiring requirements running to the station power panel for installation of power wiring.

Conduits should have all sharp edges removed.

Communications conduit shall be installed between the location of station network equipment and the location of each TVM, fare gate underfloor duct junction box, and SAV. Communication pull boxes shall also be appropriately located for length of main conduit run(s). Conduit arrangement should use main run to each general location of equipment with branch runs continuing between junction box and each TVM/SAV location and to each fare gate underfloor duct junction box. Conduit arrangement shall allow for node-type (node at communication room or cabinet) communications cable connections (between TVMs, fare gates, and SAVs, and the UFS station network equipment at communication room or cabinet) through the use of appropriately located communication pull boxes and/or junction boxes. Conduit arrangement shall support installation of both copper and fiber optic cable runs between station network equipment connected to node at communication room or cabinet and TVM with hub, and between TVM with hub to each additional TVM and SAV or fare gate within the TVM and SAV or Fare Gate Group, along with copper SCADA Interface Cable (SIC) from MDF at communication room or cabinet to each TVM Group(station platform entrance), with SIC cable connected to additional TVMs within same Group in daisy chain manner.

Dedicated, minimum 2" size conduit shall be provided from a telephone utility box/pole to the enclosure for communications to bring in and terminate telephone company cable or other communications lines as appropriate. Dedicated to fare collection communication equipment UPS powered duplex power outlet shall be provided in this communications enclosure to support power connection to UFS station network equipment power supplies. Communications room/enclosure/cabinet shall be properly grounded for communications equipment.

Pull ropes shall be installed in all conduits or underfloor ducts connecting communications enclosure/room/building (location of station network

equipment) with location of each TVM, SAV or fare gate to facilitate pulling in of necessary communications cable during installation.

Provisions for storage of power wiring and communications cabling shall be provided within pull boxes or junction boxes near TVM, fare gate underfloor duct, and SAV locations to allow for secure cable storage in the event of future machine removal or new installation. These communications and power pull boxes should be of sufficient size to allow for cable and wiring to be pulled back from stub-ups and stored. Conduits entering pull boxes shall be permanently identified as to destination using metal tags.

For locations where equipment is mounted to slab on grade, conduits need to be run a minimum of 2' below grade and sweep up into center of footprint at equipment locations.

Embedded underfloor duct shall be installed under each fare gate array extending under all fare gate console positions within the array, with one duct for power and one duct for communications. Embedded underfloor duct junction box shall be used at end(s) of underfloor ducts to transition power and communication runs to conduit.

No. 2 Walkerduct shall be minimum size used at Metro rail at grade stations with end underfloor duct junction box to intercept power run from station power panel and communications run from TVM location back to UFS station network equipment location inside the communication room or cabinet. No. 4 Walkerduct shall be minimum size used in similar manner at Metro underground Rail stations.

At Emergency Swing Gate Latch Post locations not adjacent to faregate consoles. 1" embedded conduit shall be run between underfloor duct junction box (Communications side) to location of swing gate latch post.

At telephone (PTEL and GTEL) locations, 1" embedded conduit shall be run to communication room or cabinet.

At CCTV cameras locations, 1" embedded conduit shall be run to communication room or cabinet.

At PA speakers locations, 1" embedded conduit shall be run to communication room or cabinet.

At message board locations, two (2) x 1" embedded conduit shall be run to communication room or cabinet.

### **3. Connections to Fare Collection Equipment**

Connections from the power panel and the station communications room or the cabinet at locations of TVMs and SAVs shall utilize one of two options below, Connections from same at locations of fare gate consoles shall utilize underfloor duct only.

a. Conduit Stub-ups

If conduit stub-ups are used (as opposed to underfloor duct), conduit stubs up for power (1" Branch Conduit), to secure 6 ft station ground pigtail (1" Branch Conduit), and for communications (2" Branch Conduit for TVM; 1" Branch Conduit for SAV) shall be installed in the center of each TVM/SAV footprint. Conduit stub-ups at TVM and SAV locations should be sealable with removable threaded metal plug inside metal female conduit coupling that is flush with the finish surface. Conduits stubbed into the SAV footprints shall be orientated to fit within the 4" x 6" base opening of the SAV (6" side parallel with the 14" width of the SAV) centered within the SAV footprint. These requirements shall also apply to spare TVM/SAV locations (locations with provisions to install additional machines in future).

b. Underfloor (Under platform) Raceway System

An underfloor raceway system shall have separate power and communication conduits (ducts) going to each TVM, SAV or fare gate console. Raceways shall be embedded in the floor to support all initial TVM SAV and fare gate console locations, as well as allowance for future additions of TVMs, SAVs, and fare gate consoles. Cover on underfloor duct and conductor fill shall be implemented per NEC requirements,

One end junction box shall be positioned directly above the pullbox in the slab to facilitate pulling both power and communication cables from the pull box in the structural slab into the underfloor raceway system for later connection to the fare collection equipment above.

Underfloor duct risers (aftersets) at TVM, SAV, or fare gate console locations shall be installed in the center of each TVM, SAV, or fare gate footprint, one from the communications duct and one from the power duct. Each riser shall be sealable with removable threaded metal plug that is flush with the finish surface.

For conductors run on common conduit or raceway, two additional guidelines shall apply. The voltage insulation rating of all conductors shall match the highest insulation rating. Wires for conductors in common raceway shall be shielded type wires.

#### 4. Electrical

Power conduit shall be installed to run power circuits from the station power panel to each TVM, SAV, and fare gate console location, and to the station communications facility. Conduit shall utilize intermediate power pull boxes appropriate for the length of main conduit run(s). Conduit arrangement should use main run to each general location of equipment with branch runs continuing between junction box and each TVM/SAV location.

Dedicated 120V, 60 Hz, and 20 amp circuits shall be provided at station power panel for each fare collection equipment item. Separate dedicated circuits shall be provided for each TVM, each SAV and each fare gate

console, and be UPS powered to the UFS station network equipment power supplies inside the station communications room or the cabinet. Circuits for TVMs, SAVs, and fare gates shall be essential load. The circuit for UFS station network equipment shall be critical load and shall be provided directly from the communication UPS power panel, terminated at duplex outlet adjacent UFS network equipment rack location. Each circuit shall be labeled on the power panel. Three-conductor (Line/Neutral/Ground) circuit with dedicated neutrals shall be provided from power panel to each equipment (TVM, SAV, or fare gate) location. Power conductors shall be #12 AWG minimum, XHHW-insulated, and sized per the National Electrical Code (NEC). A six-foot wiring pigtail shall be provided at each TVM, SAV, and fare gate console location to allow for connection of power conductors to equipment.

Power wiring shall be kept separate of communications cabling and shall be run continuously, without splices, from source to each TVM, SAV, and fare gate console location including identified future locations.

## 5. Communications Equipment

Each station will require a station communications room or the cabinet, within or near the station facility for fare collection equipment personnel to install required station network equipment. The internal space requirements to support the UFS station fare collection equipment (TVMs/SAVs fare gates) communication system is 24" of rack space for vertical rack mounting on standard 19" racks with this rack space to be located on upper portion of lower half of the rack. The rack space for UFS station network equipment shall include duplex outlet on critical power circuit dedicated to same. Station network equipment will consist of hubs, routers, power supplies, fiber optic network equipment, and copper/fiber cabling; and will interface to the Cable Transmission System Sonet Node at same location via connection to a dedicated (to UFS) RPR Ethernet card provided by the Communications contract to support data communication between TVMs, SAVs, and fare gates and the Central Data Collection System (CDCS) computer located on second floor of the Metro Union Station Gateway (USG) building using RPR Ethernet (10/100 Base T) connectivity. Two dark fiber optic strands, daisy chained at each station, shall be provided for fare collection equipment communications path to USG as well as space and power for future fiber optic multiplexing equipment in the communication room or the cabinet. In addition, a minimum 2" communication conduit connection shall be provided to local phone company point of connection to allow local phone company circuit termination inside the communication room or the cabinet. The communication room or the cabinet shall also be equipped with appropriate air conditioning to keep equipment within their specified temperature range for performance.

Communications cabling shall be kept separate of power wiring; and shall be run continuously, without splices, from source to System Components location.

### 9.2.6 Sizing Methodology

All calculations must be done based on Maximum Line Capacity requirements and based on projected ridership minimum Metro policy requirement. For fare gates, final quantities shall be established based on Maximum Line Capacity Requirement, modified as necessary by results of queuing modeling analysis and as necessary to comply with NFPA 130 station egress requirements.

#### A. Parameters and Overall Methodology – TVMs and SAVs

This section describes the method used for calculating total quantities of TVMs and, at stations without fare gates, SAVs required at a station beyond the minimum quantity requirements stated above. General principles for allocating the calculated totals to separate arrays are also indicated.

Calculations of TVM and SAV quantities are made for each station's AM and PM peak patronage, including surges due to arriving buses and trains at connecting stations. Whichever period requires the greater number of pieces of equipment governs. Passenger volumes may be revised by future studies or data.

Fare collection equipment is grouped by array. Each fare array is a grouping of TVMs and SAVs within a free area. Allocation of the total number of pieces of equipment to each array in a station is based on station configuration, and site-access-related factors.

#### B. Calculation Methodology

Enough ticket vending machines shall be provided at a station so that no passenger will be required to wait more than two minutes for a TVM or twenty seconds for a SAV.

Equipment quantity needs shall be developed using a queuing model that analyzes machine usage patterns to determine the effect of different equipment quantities on passenger throughput and wait times. The model output shall be the maximum process time – queuing plus actual transaction time – for various alternative numbers of machines available at each station. Required functionality of the model is summarized below.

The model requires input data to calculate a number of intermediate variables. These are used to determine final maximum wait time statistics.

Input Data include:

- System-wide inputs apply to all stations:
  - Ridership growth adjustment
  - Month of year adjustment
  - Day of week adjustment
  - Machine availability percentage (minimum 95%)
  - Mean transaction time by form of payment or transaction (for example, average transaction time needed to purchase a 20-trip ticket from a TVM if using two \$10 bills.)



- Distribution of payment / transaction types (percentage sold by the TVM that is expected to be paid by each combination of coins and bills.)
- Inputs for individual station:
  - Daily ridership
  - AM peak ridership
  - PM peak ridership
  - Ridership surge percentage (the percent by which sudden surges exceed the “constant arrival rate”, for example as would be caused by a train arriving at the North Hollywood station)
  - Proportion of ridership of each fare type among machine users
  - For each type fare equipment projected usage counts, including daily, AM peak and PM peak.

Given these data inputs, each station spreadsheet then automatically calculates several intermediate variables that will be used to determine final maximum wait time statistics for each type of fare equipment:

- Equipment composite peak hour transaction time by station
- Adjusted peak hour ridership by station – Based on ridership multiplied by the adjusted ridership growth
- Total peak hour equipment users by station – Based on the adjusted peak hour ridership
- Average passenger processing time for each alternative numbers of machines (ex. Process time for the option of 1 to 25 TVMs are available)

Given these data inputs and intermediate variables, each station spreadsheet then automatically calculates the final maximum wait time for each type of fare equipment based on the number of each equipment type available.

If the calculated number of TVMs is less than two per array (at separate entrances), two TVMs and two SAVs shall be used. At station platforms with more than one entrance, a single TVM and a single SAV may be placed at each entrance. Exceptions to the minimum requirement shall be made only after review of the individual station’s layout (with consideration for safety of passengers who may cross the vehicle path to reach alternate ticket vending machines or locations), the fare processing rate of each machine, and the reliability of the procured fare collection equipment,

#### C. Parameters and Overall Methodology – Fare Gates

All station designs considered for implementation of fare gating shall have queuing analysis/modeling and exit calculations performed to determine feasibility in station design. Where not feasible, station designs shall utilize Stand-Alone Validators (SAVs) in lieu of fare gates, with SAVs placed in the Virtual Gate arrangement at or near entrances to platform boarding areas.

##### 1. Queuing Analyses/Modeling:

Queuing analysis/modeling of station design, number of initially proposed fare

gates and Metro ridership forecasts shall be performed to determine appropriate fare gate quantities for station entrances considered for fare gating.

- Ridership forecasts used shall be based on 10-year out forecasts and Maximum Line Capacity developed by Metro Operations.
- Surge time, the length of time between the first and last person arriving at the fare gates during a surge, shall be determined based on distance from the mid-point of the station platforms to the planned fare gate areas. For evaluation, both one and two minute surges times shall be evaluated when this distance is less than 200 feet, and only the two minute surge time shall be used for distances greater than 200 feet.
- Passengers per peak surge (1-2 minutes) shall be derived from ridership forecasts.
- The peak surge demand (the highest amount of arrivals at a fare gate within a 1-2 minute time period) shall be dependent upon the number of trains that arrive at each station during a peak hour.
- The number of people per 10 seconds (demand) over the surge period shall be determined and compared with worst case fare gate capacity and existing fare gate capacity.
- Worst Case fare gate capacity shall be 3 second service time per person
- Existing fare gate capacity shall be 2 second service time per person
- Maximum wait time (seconds), Maximum number of people in queue, and Maximum queue length (feet) per gate shall be determined based on both Worst Case and existing fare gate capacities.
- Maximum wait time is the maximum time a person entering at the peak of a queue length would have to wait.
- Maximum number of people in queue is the expected maximum amount of people that will be delayed at the fare gates.
- Maximum queue length per gate is the queue space that would be needed behind each fare gate to accommodate people waiting in the queue, based on the maximum number of people in the queue.
- Fare gates that serve only elevator passenger flow shall be considered negligible due to varying elevator utilization factors, service times and capacities.
- The peak surge flow shall be applied to all turnstile and ADAAG leaf barrier fare gates that are not elevator-only to represent a worst case situation. The throughput of turnstile and ADAAG leaf barrier fare gates shall be considered equivalent in the analysis.
- A maximum queuing time of 55 seconds during surges shall be considered an acceptable service standard.
- Wait time results shall be evaluated as follows:
  - Less than 5 seconds - No significant queues
  - 5-30 seconds – Slight queues
  - 30-55 seconds – Noticeable queues
  - Greater than 55 seconds – Significant queues

The quantity of fare gates recommended shall be based on maintaining the maximum queuing times below a 55 second service standard during the worst case scenario (3 seconds per person per fare gate).



## 2. Exit Calculations:

Exit Calculations shall be performed for Metro Rail stations to evaluate impact of fare barriers on station egress. Exit calculations for station shall be performed in accordance with current edition of NFPA 130, Standard for Fixed Guideway Transit and Passenger Rail Systems, to determine results of 4 minute tests, 6 minute tests, and waiting times at fare barriers for station egress specified within.

- Calculations shall be based upon use of 10 year ridership projections and Maximum Line Capacity as furnished by Metro Operations.
- Ridership projections shall be used to derive maximum hourly entraining loads in both peak and off-peak directions, which based on surge factor and headway, shall be used to derive peak and off-peak entraining loads to arrive at total entraining load for platform.
- Train loads shall be based on crush load capacity of train in peak direction and one-half seated load capacity of train in off peak direction.
- Total Occupant Load shall be the sum of the total entraining load and total train loads based on crush capacity defined by Metro.
- Comparison of total entraining load to Net Platform Area divided by 4 square feet per person shall be made to determine if constrained platform access required.
- The greater number of total occupant load compared to Net Platform Area divided by 7 square feet per person shall be made to determine number to use for egress calculation.

Fare gate equipment used, including turnstile fare gates, ADAAG barrier leaf fare gates, and emergency swing gates, shall be based upon the existing Cubic Transportation Systems, Inc. (Cubic) design used on Metro's UFS Gating Project.

Capacity for exiting for each fare barrier element shall be the following per current edition of NFPA 130, Standard for Fixed Guideway Transit and Passenger Rail Systems, NPFA 130:

- Turnstile Fare Gate Aisle: 25 PPM (People Per Minute) (2010 edition)
- ADAAG Barrier Leaf Fare Gate Aisle: 50 PPM (2010 edition)
- Emergency Swing Gate:  $PPM = \text{Width of swing gate opening} \times 2.08 \text{ PIM}$

Gate-type exits shall be provided in each fare barrier to provide minimum of 50% of total barrier exit capacity in accordance with current edition of NFPA 130, Standard for Fixed Guideway Transit and Passenger Rail Systems, Section 5.5.6.3.3.4 (Doors and Gates, 2010 edition).

Exit Calculations shall assume worst case scenarios, including but not limited to:

- Maximum ridership based on fully loaded peak entraining load
- Two trains arriving simultaneously on the platform
- Maximum length trains operating in peak and off-peak directions
- Crush capacity of 400 people per Metro Heavy Rail "married pair" per Metro

Fire/Life Safety Recommendation, and 220 per Light Rail articulated vehicle per Metro Fire/Life Safety Recommendation.

- Walking distance beginning from the furthest point on station platform and ending at Point of Safety (defined by Metro)
- Do not consider emergency exits that lead only to the track area

Exit calculations together with station gating layout design shall be reviewed and approved by Metro Fire/Life Safety

### **9.2.7 Security Monitoring**

CCTV cameras shall be positioned to provide full coverage of the front of each TVM array, each fare gate array facing entering people and fare gate array facing exiting people, and coverage of SAVs to support patron and equipment security monitoring.

CCTV cameras shall be positioned to provide full coverage of the face of the patron communication on PTEL or GTEL

Station lighting levels in area of TVM arrays, fare gate arrays, and SAVs will need to be sufficient to support patron and equipment security. For minimum lighting requirement/criteria, refer to Metro, IES, and ANSI criteria and recommendations.

### **9.2.8 UFS Communications**

#### **A. Scope and General Description**

Labeled pull ropes shall be provided in each communication conduit and underfloor duct.

#### **B. Communication Link Requirements**

Each station will require:

- All infrastructure requirements for leased phone line and conduits infrastructure provisions
- All equipment necessary for one RPR Ethernet (10/100 Base T) connectivity at each station and at ROC, including dedicated (for UFS) RPR Ethernet Card installed in node at each station and at ROC.
- Two dark fiber optic strands, daisy chained at each station, for UFS communication path to Gateway as well as space and power for the future fiber optic multiplexing equipment in the communication room or the cabinet.

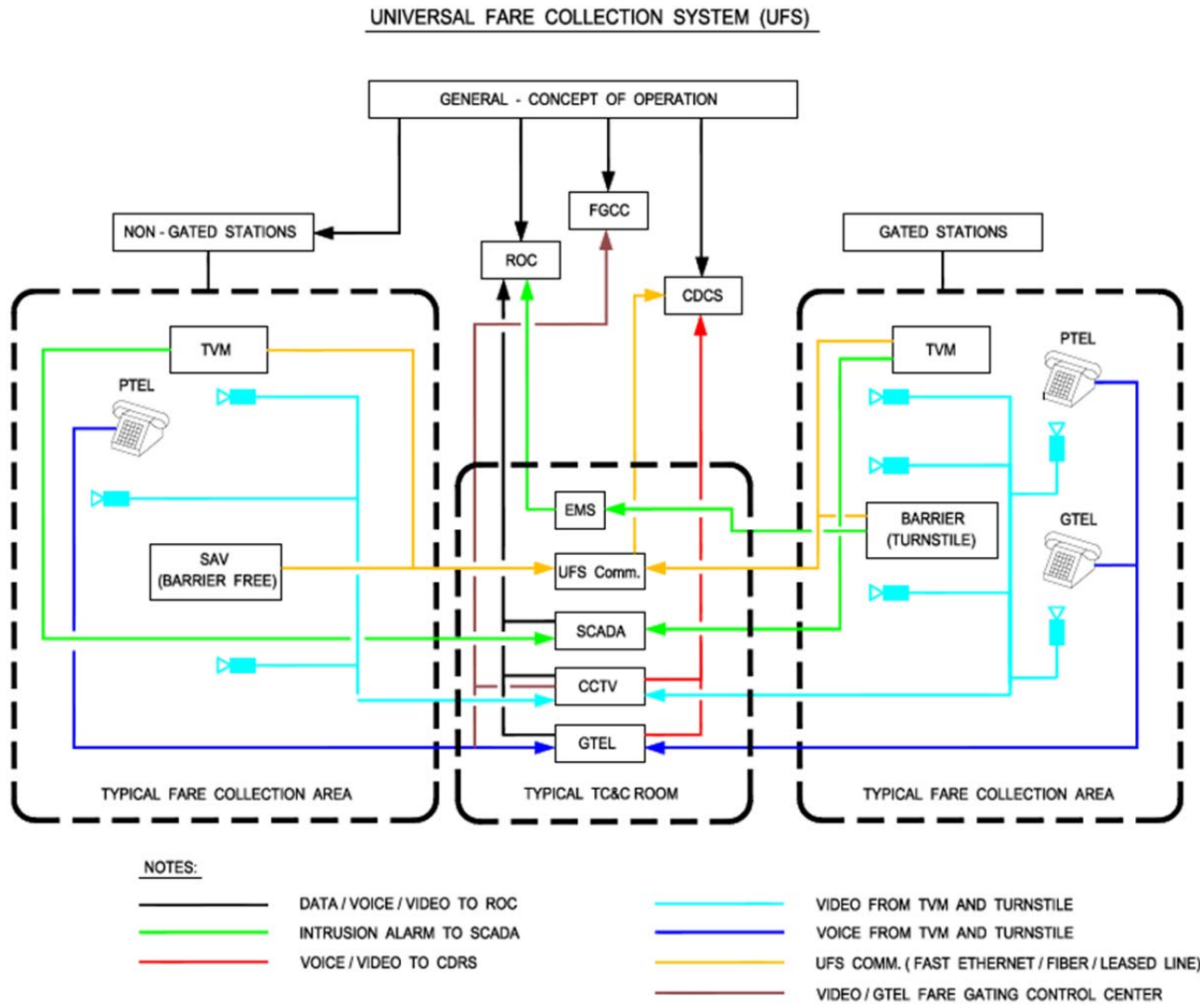
#### **C. SCADA Interface Requirements**

SCADA input (voltage provided by SCADA) shall be provided for the TVM Vibration/Intrusion Alarm. One set of SCADA alarm points shall be provided at the station MDF within the communication room or the cabinet for each TVM Group within the station. The SCADA Interface cable shall be installed in the 2" UFS communications conduit between TVMs and the MDF in the communication room or cabinet. This cable will connect each TVM within a TVM Group together in daisy chain manner to the MDF. Opening of Normally-Closed dry contact within any TVM

in a TVM Group shall result in SCADA alarm indication at ROC for the TVM Group security condition.

D. Evacuation Message Interface (EMS) Interface Requirements

Normally Closed dry contacts shall be provided for the Fare Gate Array/EMS interface. One Normally Closed dry contact shall be provided at the MDF within the communication room or the cabinet for each fare gate array within the station, The EMS pair running in the 2" UFS communications conduit between the MDF in the station communication room or the cabinet from each fare gate array must be terminated at the MDF. Opening of the Normally-Closed dry contact shall occur automatically upon activation of the Evacuation Message System from ROC or locally from the station Emergency management Panel (EMP) for underground stations; and upon activation of the station Fire Control Panel (FCP) at all stations. Upon the activation, the fare gates shall go into Emergency Mode causing turnstiles to free-spin and barrier leafs to retract, plus cause electric latch on each swing gate de-energize (release) to support emergency exiting of public from paid area of station as required by NFPA 130.



### 9.3 RAIL VEHICLES INTERFACE

#### 9.3.1 Introduction

This section **only** summarizes the required functional, operational, and physical characteristics of Metro Transit Rail Vehicles. This section is intended to provide a definition of the **existing** vehicles to assist in the design of fixed facilities. **This section is not intended to serve as design criteria, or specifications for future vehicle procurements, as well as to serve as a source of information to other designers. All future vehicle procurements will be defined on the basis of equipment previously procured to assure operating compatibility and optimized logistics. All vehicles shall be in accordance with all rules and regulations of the Americans with Disabilities Act (ADA), and other related regulatory provisions of other government agencies having jurisdiction shall be used for additional guidelines.**

#### 9.3.2 Vehicle Characteristics

##### A. General

The vehicles defined in this Section will be for Light Rail Projects **and Heavy Rail Projects**.

The vehicles may be of the articulated or married-pair type, double ended, four doors on each side for articulated type and three doors per side for the married pair type, with access from high-level platforms. The vehicles shall utilize in design and construction as much "off-the-shelf" technology as possible. The center truck shall be unpowered if the vehicle is of the articulated type. The design minimum service life of the vehicles shall be 30 years. Each lead vehicle in a consist shall be equipped with at least a horn and headlight to assist in alerting station occupants to an arriving train. Materials shall be based on characteristics of:

##### **Light Rail Vehicles: (P865/P2020, P2000, P2550 and P3010)**

- **Articulated**
- **Double Ended**
- **Four (4) doors on each side (Total 8 per car, 16 per vehicle)**
- **Access from high-level platform**
- **The vehicles shall utilize in design and construction as much" off-the-shelf" technology as possible.**
- **Center truck shall be unpowered if the vehicle is of the articulated type**
- **The design minimum service life of the vehicles shall be 30 years**
- **Each lead vehicle in a consist shall be equipped with at least a horn and headlight to assist in alerting station occupants to an arriving train**
- **Power Collection System – Pantograph, one per Vehicle, 750 Vdc**

##### **Heavy Rail Vehicles: (A650 Base and Option)**

- **Married–Pair (MP) attached by a semi-permanent coupler**
- **Double Ended**
- **Three (3) doors per side (Total: 6 per Vehicle, 12 per MP)**
- **Access from high-level platform**
- **The vehicles shall utilize in design and construction as much" off-the-shelf" technology as possible.**

## **METRO RAIL DESIGN CRITERIA**

- **The design minimum service life of the vehicles shall be 30 years**
- **Each lead vehicle in a consist shall be equipped with at least a horn and headlight to assist in alerting station occupants to an arriving train**
- **Power Collection System – Third Rail “Collector-Shoe” two per truck, 750 Vdc**

**A current collector/contact rail isolation device, suitable for on-board vehicle storage shall be provided.**

- ~~Resistance to vandalism and graffiti.~~
- ~~Ease of cleaning and maintenance.~~
- ~~Compliance with fire, smoke emission and to industry standards.~~

### **B. Operating Characteristics**

**Vehicles operate as single units, or as multiple units consisting of:**

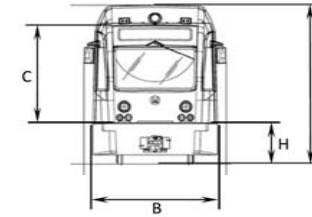
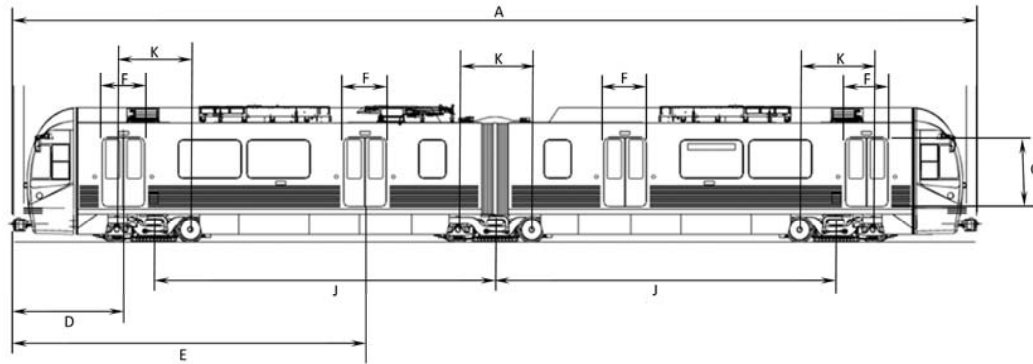
- **Two or three Light Rail vehicles and in an emergency operation of up to twice that number of vehicles.**
- **Two or three Heavy Rail vehicles (Married Pairs) and in an emergency operation or dead tow only Two married pairs.**

~~Vehicles shall be capable of operating as single units or as multiple units consisting of two or three Light Rail vehicles and in an emergency operation of up to twice that number of vehicles. The vehicles shall be designed as a minimum, for manual operation with an Automatic Train Protection (ATP) system to enforce system imposed maximum speeds.~~

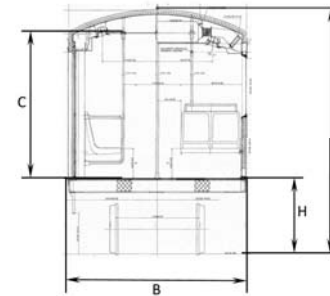
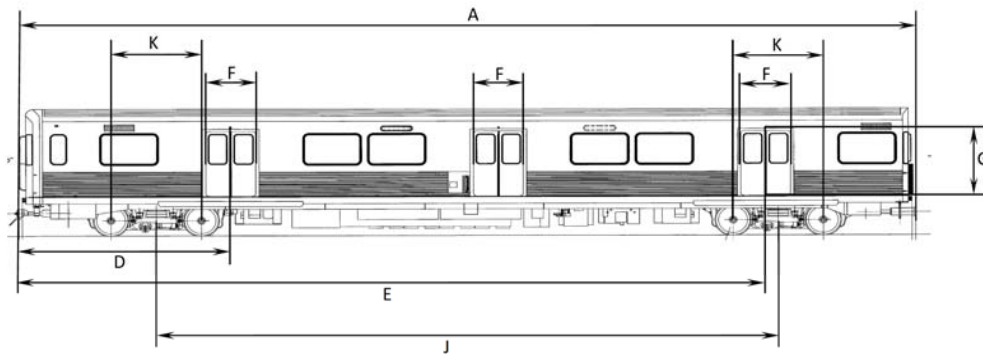
~~Vehicles shall also be capable of operation without ATP, or Automatic Train Supervision (ATS) if necessary due to an emergency situation or an ATP or ATS system failure, or if in uncontrolled territory. A configuration that allows for driverless operation may also be considered. Driverless criteria will be developed at that time.~~

C. Vehicle ~~Body Basic~~ Dimensions

Light Rail Vehicle Figure 9.3.1.a



Heavy Rail Vehicle Figure 9.3.1.b



**Table 9.3.1  
LIGHT RAIL AND HEAVY RAIL CARBODY BASIC DIMENSIONS**

*"Note: TOR=Top of Rail"*

Figure 9.3.1.a and 9.3.1.b Reference:	Dimension Description	Light Rail Vehicles (LRV)				Heavy Rail Vehicles (HRV)
		P2000	P2550	P865/P2020	P3010 Preliminary	A650 Base and Option
A	Coupler to Coupler	27.14 m (89'- 0 19/32")	27.43 m (89'-11 59/64")	27.12 m (89'- 0")	27.13 m (89', 0")	22.8 m ( 75'- 0")
		89'-0" Nominal to 89'-11 59/64" Maximum				75'- 0" Maximum
B	Width of car body over thresholds	2653.9mm (8'-8 31/64")	2651.1mm (8'-8 3/8")	2660.7mm (8'-8 ¾")	2660 mm (8'-8 7/12")	3,149.6 mm (10'- 4")
		8'- 8 3/8" Nominal to 8', 8 3/4" Maximum				10'-4" Maximum
C	Ceiling to floor	2093.9mm (6'-10 7/16")	2049.9mm (6'- 8 45/64")	2044.7mm (6'- 8½")	2044.7mm (6'- 8½")	2184.4 mm (7'- 2")
		6'- 8 7/16" Nominal to 6'- 10 7/16" Maximum				7'- 2" Maximum
D	Coupler face to C/L front door	3111.5mm (10'-2½")	2700.3mm (8'-10 5/16")	2844.8mm (9'-4")	2800mm (9'- 2")	5397.5 mm (17'- 8½")
		9'- 2" Nominal to 10'- 2 1/2" Maximum				17'- 8½" Maximum
E	Coupler face to C/L rear door	10.00m (32'- 9 45/64")	9.30m (30'- 6 3/32")	10.00m (32'-10")	9.7m (31'- 10")	19,037.5 mm (62'- 5½")
		30'-6 3/32" Nominal to 32'- 10" Maximum				62'- 5½" Maximum
F	Door opening (Width)	1239mm (4'- 0 25/32")	1220mm (4'- 0 1/32")	1219.2mm (4'-0")	1220 mm (4'-0")	4'-2" Maximum
		4'-0" Nominal when fully open				4'- 0" minimum when fully open to 4'-2" Maximum
G	Height of passenger side doors	1930 mm (6'- 3 31/32")	1910 mm (6'-3 3/16")	2044.7 mm (6'- 8½")		1905 mm (6'- 3")
		6'-3" Nominal				6'-3" Nominal
H	Height of floor above TOR	1003 mm (3'-3")	990 mm (3'- 3")	990 mm (3'-3")	996 mm (3'-3")	1114.2 mm to 114.5 mm (3'- 8 23/32")
		3'-3" Nominal to 3'- 3 14/32" Maximum				1114.2 mm Nominal to 114.5 mm (3'- 8 23/32") Maximum
I	Height of car from top of the roof mounted equipment to TOR (Static)	3710 mm (12'-2 1/16")	3810 mm (12'-6")	3505.2 mm (11'-6")	3810 mm (12'- 6")	3665 mm* ( 12'- 0 ¼") *not including Antenna Approx. 127 mm (5")



D. Truck Dimensions:

**TABLE 9.3.2  
LIGHT RAIL AND HEAVY RAIL TRUCKS BASIC DIMENSIONS**

Figure 9.3.1.a and 9.3.1.b Reference:	Dimension Description	Light Rail Vehicles (LRV)				Heavy Rail Vehicles (HRV)
		P2000	P2550	P865/P2020	P3010 Preliminary	A650 Base and Option
J	Distance between truck centers	9677 mm (31'- 8 31/32")	9750 mm (31'- 11 27/32")	9448.8 mm (31'- 0")	9410 mm (30'- 10 2/5")	15850 mm (52')
		30'-10 2/5" Nominal to 31'- 8 31/32" Maximum				52' Nominal to 54' Maximum
K	Wheel Base	2100 mm (6'-10 11/16")	2101 mm (6'-10 11/16")	1900 mm (6'- 2 13/16")	2150 mm (7'- 0")	2300 mm (7'-6 9/16")
		6'- 2 13/16" Nominal to 7'- 0" Maximum				7'- 7" Maximum
NA	Wheel diameter: a) new, b) wear limit of condemning limit diameter	a) 28", b) 26"	a) 28", b) 26"	a) 28", b) 26"	27.99 "	a) 34", b) 30"
		NA				NA
NA	Standard track gauge	1435.1mm (4'-8 1/2")	1435.1mm (4'-8 1/2")	1435.1mm (4'-8 1/2")	1435.1 mm (4'-8 1/2 ")	1435.1mm (4'-8 1/2")
		NA				NA

E Vehicle Weight and Design Loading:

**TABLE 9.3.3  
LIGHT RAIL AND HEAVY RAIL MAXIMUM WEIGHTS**

	P2000	P2550	P865/P2020	P3010 Preliminary	A650 (Heavy Rail)
AW0* (lb)	98,043	108,180	94,000	TBD	80,000
Maximum Design Weight (lb)	139,334 AW4*	149,075 AW4*	134,900 AW4*	TBD	126,354 AW3*

\*Note: AW0 = Empty car operating weight,  
 AW3 = Standees at 6 persons per square meter + AW1  
 AW4 = Standees at 8 persons per square meter + AW1

F. Jacking Pad (JP) Location

FIGURE 9.3.2.a  
LIGHT RAIL VEHICLE JACKING PAD LOCATIONS

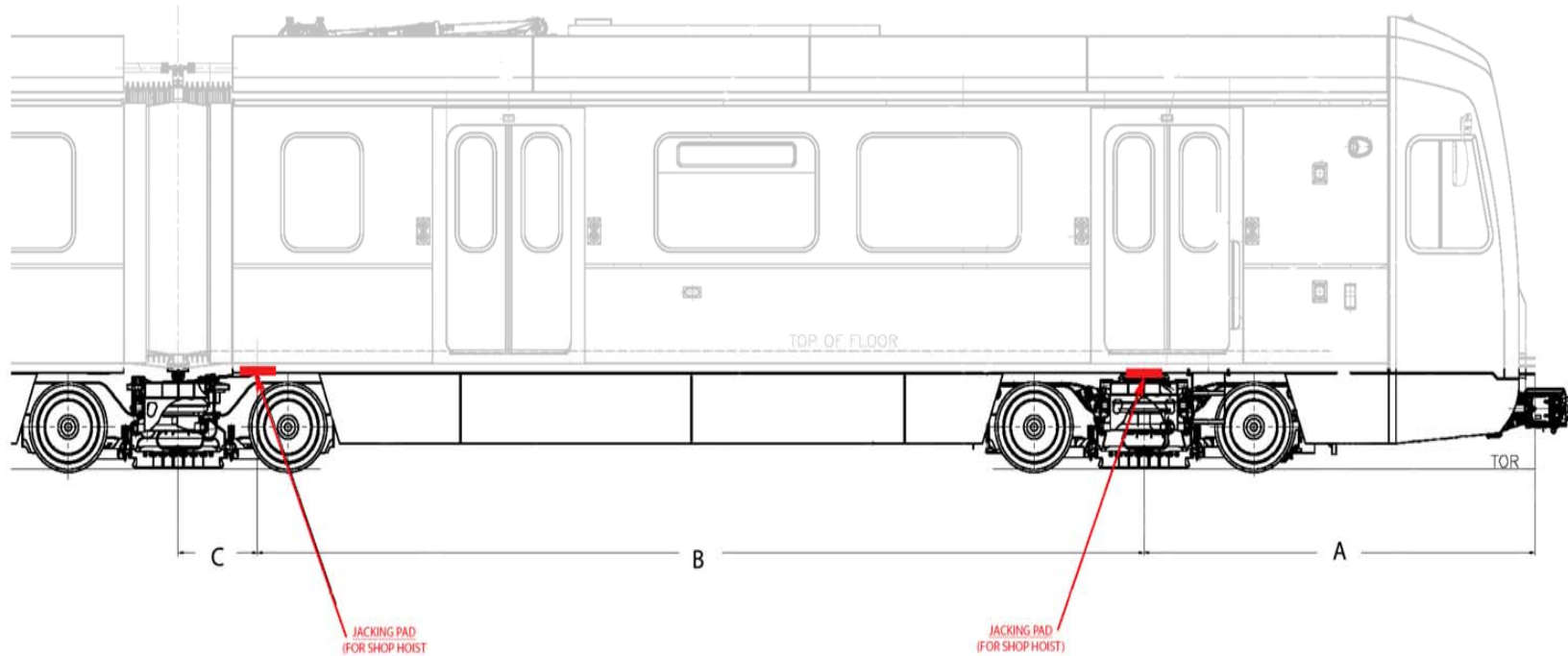
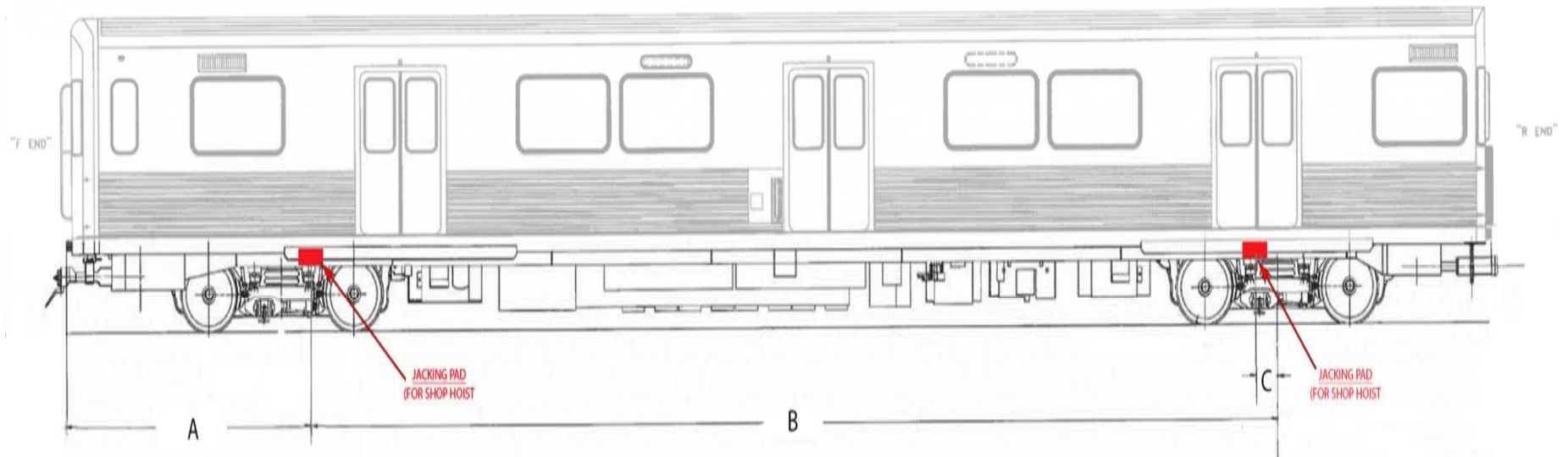


TABLE 9.3.4.a  
LIGHT RAIL VEHICLE JACKING PAD LOCATIONS

Figure 9.3.2a Reference	Dimension from:	Light Rail Vehicles (LRV)			
		P2000	P2550	P865/P2020	P3010 Preliminary
A	Anticlimber to Center of Front JP	3823mm (12'-6 1/2")	4095mm (13'-5 7/32")	3708.4mm (12'-2")	3823.9 mm (12'-6 9/16")
B	Center of Front JP to Center of Rear JP	8674mm (28'-5 1/2")	8712.5mm (28'-7")	8658.2mm (28'-4 7/8")	8675mm (28'-5 17/32")
C	Center of Rear Truck to Center of Rear JP	775mm (2'-6 1/2")	652.5mm (2'-1 11/16")	673.1mm (2'-2 1/2")	775mm (2'-6 1/2")

**FIGURE 9.3.2.b  
HEAVY RAIL VEHICLE JACKING PAD LOCATIONS**



**TABLE 9.3.4.b  
HEAVY RAIL VEHICLE JACKING PAD LOCATIONS**

Figure 9.3.2.b Reference	Heavy Rail Vehicles (HRV)	
	Dimension from:	A650 Base and Option
A	Anticlimber to Center of Front JP	3861mm (12'-8")
B	Center of Front JP to Center of Rear Truck	15494mm (50'-10")
C	Center of Rear Truck to Center of Rear JP	356mm (1'-2 1/32")

## **METRO RAIL DESIGN CRITERIA**

---

### **G. Regenerative Braking – Current Limits as measured in voltages (Vdc)**

These values are based upon the OEM's calculated measurement for each vehicle.

- 825 Vdc line voltage for Ansaldo-Breda A650
- 900 Vdc line voltage for Siemens P2000
- 920 Vdc line voltage for Ansaldo-Breda P2550
- 860 Vdc line voltage for Nippon-Sharyo P865/P2020
- Kinki-Sharyo P3010 TBD.

### **H. Wheel Profile – As built Drawing**

- The Metro Red Line Ansaldo-Breda A650 Heavy Rail Vehicle (HRV) utilizes the Resco Wheel Profile while the other Light Rail Vehicles (LRV), i.e. Ansaldo-Breda P2550, Nippon-Sharyo P865/P2020, and Siemens P2000, uses the RTD-1 Wheel Profile.

FIGURE 9.3.3.a RESCO WHEEL PROFILE ANSALDO-BREDA A650

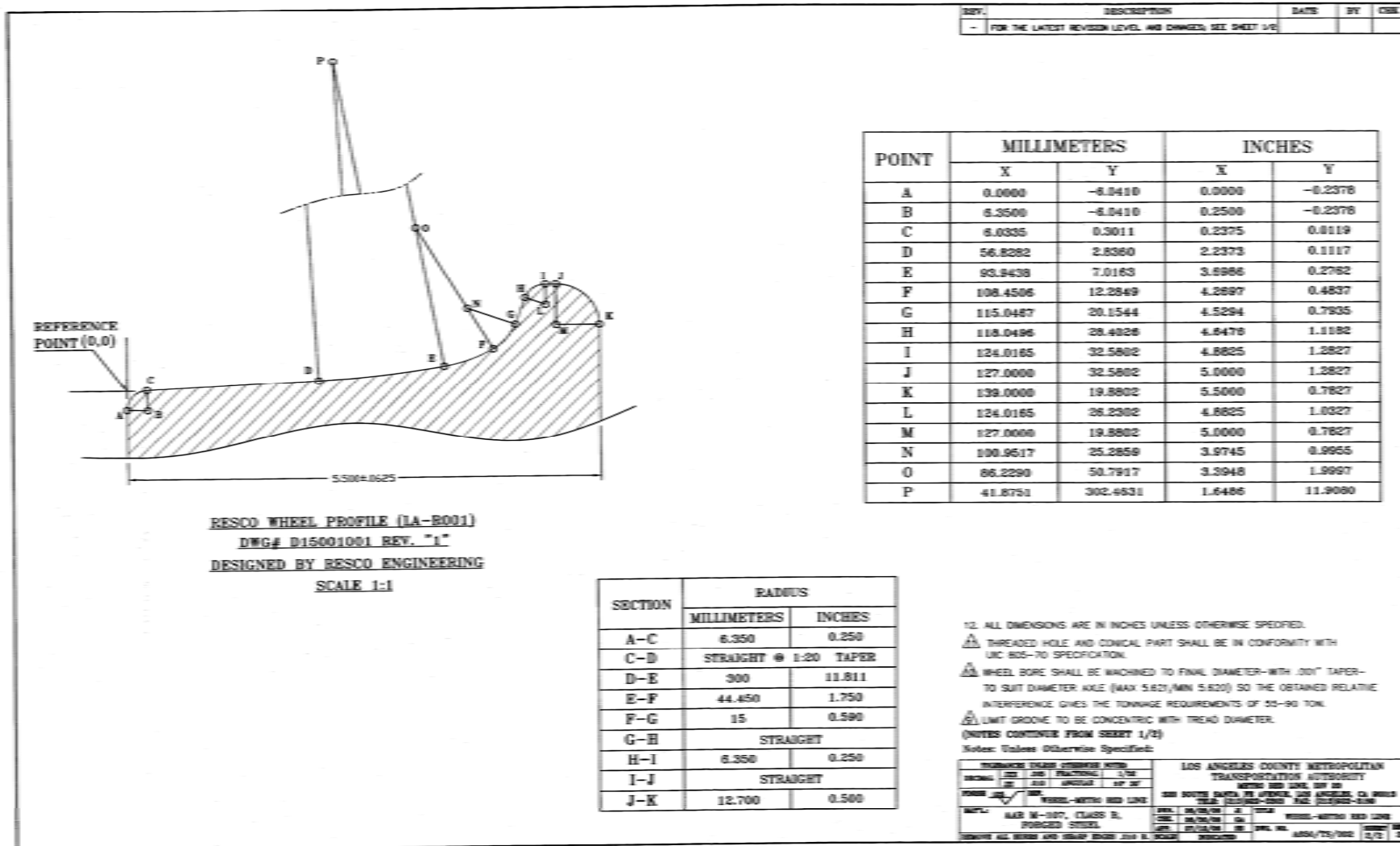


FIGURE 9.3.3.b RTD-1 WHEEL PROFILE SIEMENS P2000

PM9385

REV 9

SIEMENS P2000

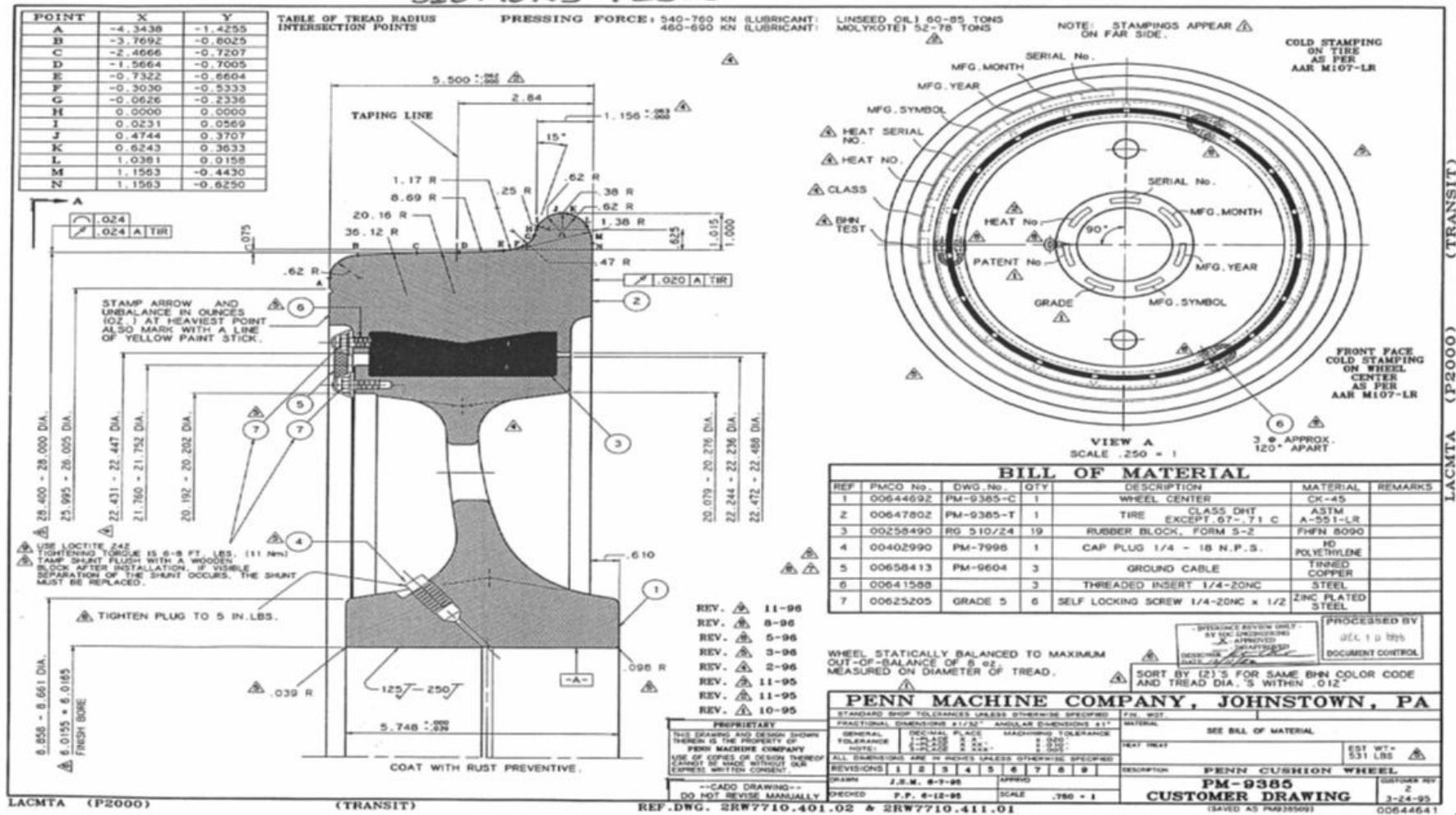
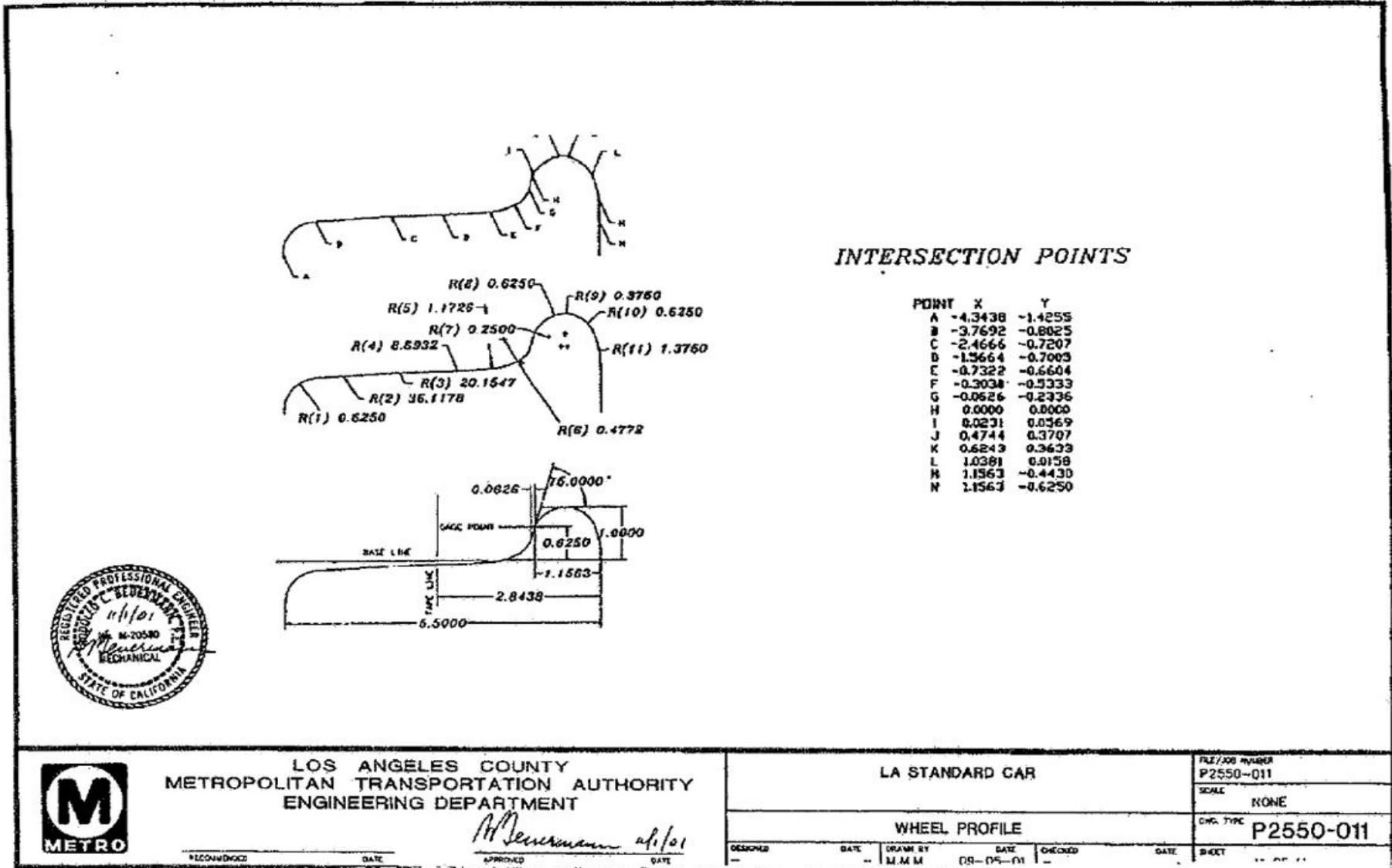


FIGURE 9.3.3.c RTD-1 WHEEL PROFILE ANSALDO-BREDA P2550



LOS ANGELES COUNTY  
METROPOLITAN TRANSPORTATION AUTHORITY  
ENGINEERING DEPARTMENT

*M. Seemann* 11/101

LA STANDARD CAR

FILE/JOB NUMBER	P2550-011
SCALE	NONE
CHG. TYPE	P2550-011

WHEEL PROFILE

DESIGNED	DATE	DRAWN BY	DATE	CHECKED	DATE
		M.M.M	08-05-01		



FIGURE 9.3.3.d RTD-1 WHEEL PROFILE NIPPON-SHARYO P865/P2020

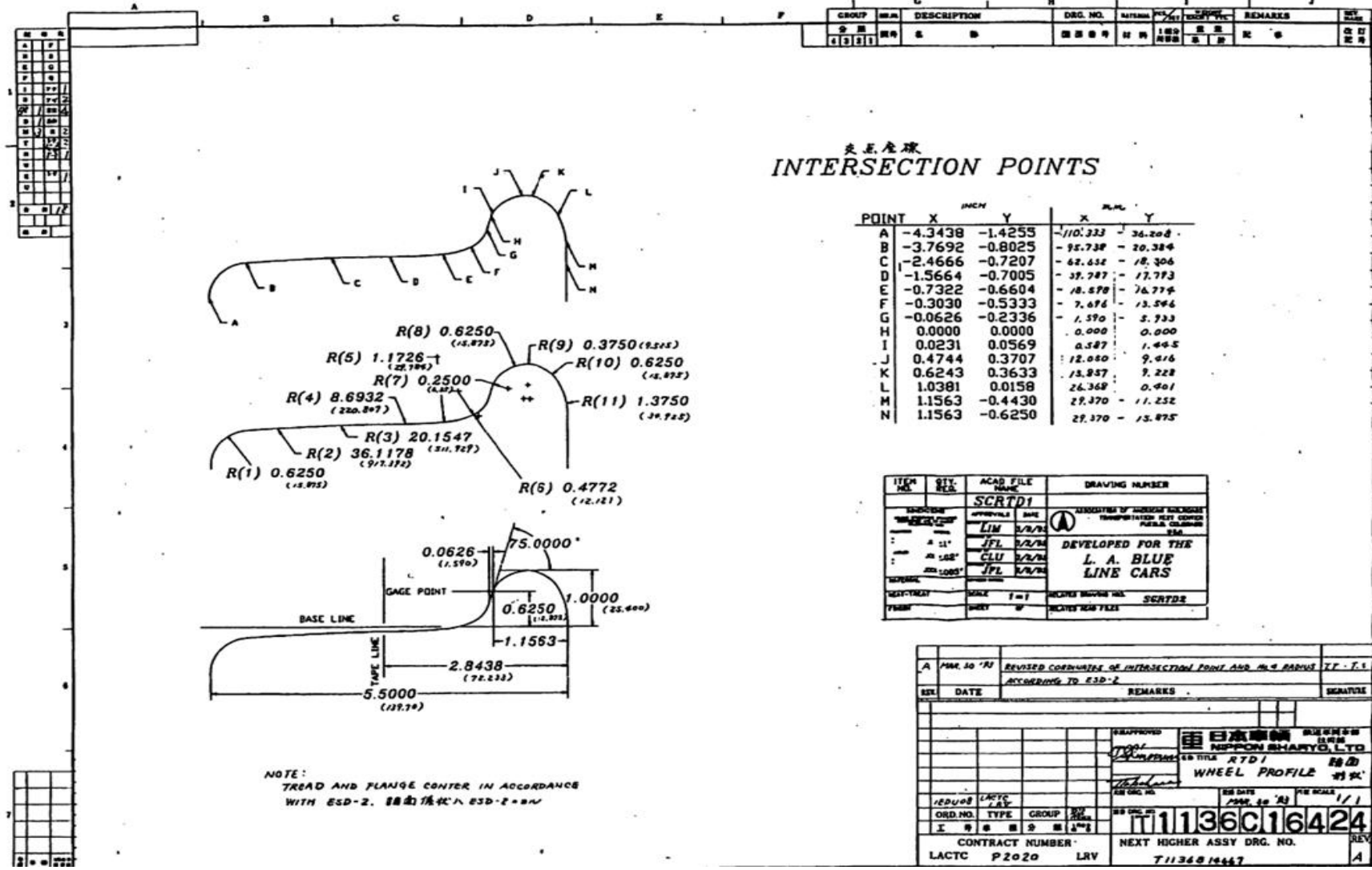
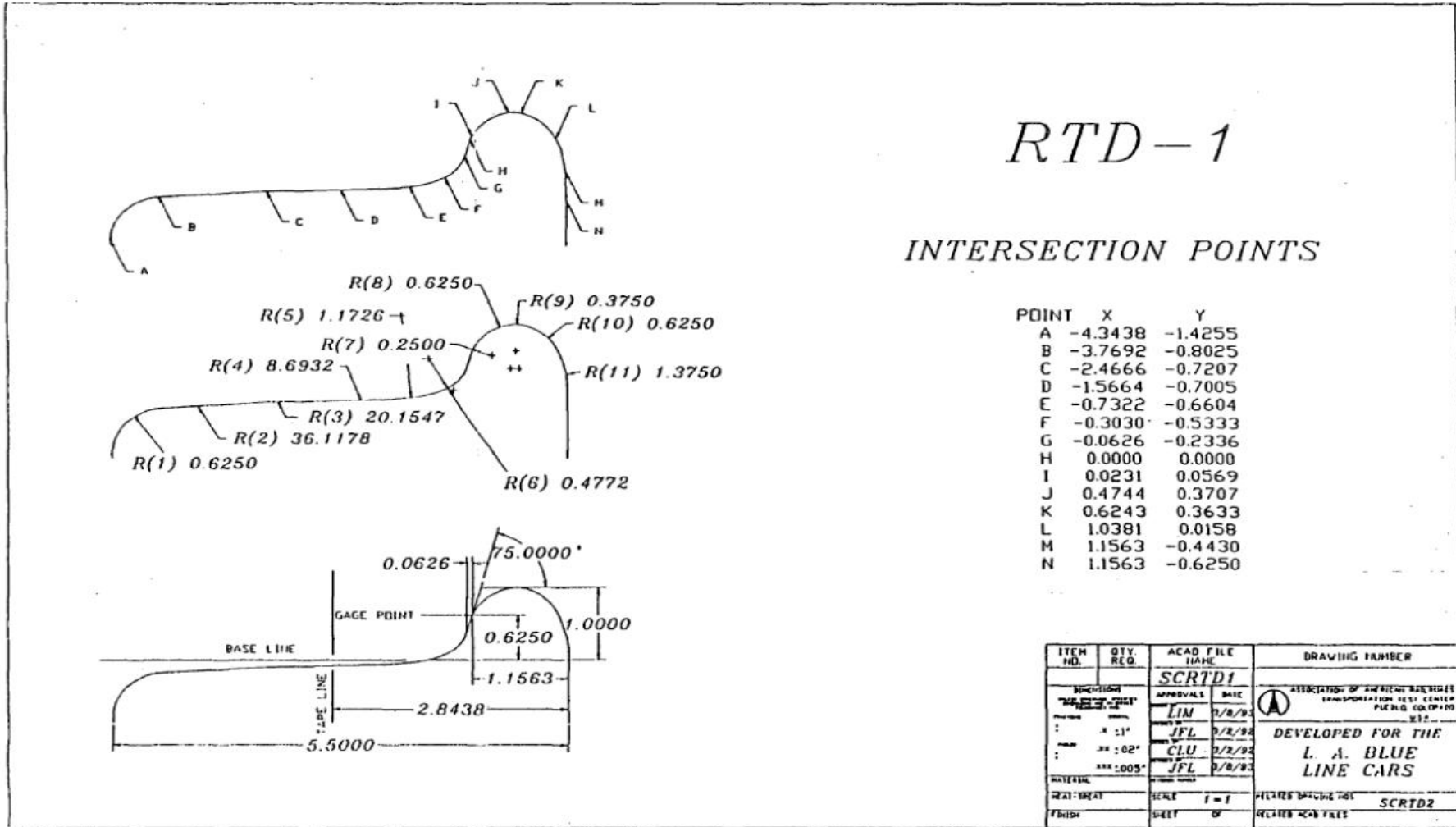




FIGURE 9.3.3.e RTD-1 WHEEL PROFILE KINKI-SHARYO P3010  
 (per Technical Specification will need to be updated once Kinki-Sharyo submits official drawings)



Vehicle Body Basic Dimensions	Light Rail Vehicle	Heavy Rail Vehicle
Length of car over coupler faces	89'-0" nominal 93'-0" maximum	75'-0" maximum
Overall width of car	9'-8 9/16" to 8'-8 3/4" maximum	10'-6" maximum
Width of car at thresholds	8'-8 5/16" to 8'-8 3/4"	10'-3 7/8" to 10'-4"
Width of passenger side doors	4'-0" minimum when fully open	4'-0" minimum when fully open
Width of end door openings	N/A	32" to 34"
Height of passenger side doors	6'-3" minimum	6'-3" minimum
Height of end doors	N/A	6'-3" minimum
Height of floor above top of rail	39"; +1/2", -1/4"	44 3/4"; +0, -1/2"
Height of car from top of roof mounted equipment to top of rail (Static)	12'-6" maximum (Pantograph locked down) 12'-3" maximum without Pantograph	12'-4 11/16" maximum
Interior height from floor to low ceiling (at car centerline)	6'-8"	6'-8" minimum

D. Truck Basic Dimensions

The truck basic dimensions are:

Truck Basic Dimensions	Light Rail Vehicle	Heavy Rail Vehicle
Minimum running clearance of trucks with fully worn wheels and maximum suspension deflection	2 1/2" (except track brakes)	2"
Distance between truck centers	30' to 32'	52' to 54'
Truck wheel base	6'-0" to 7'-0"	7'-7" maximum
Wheel diameter: a) new, b) wear limit of condemning limit diameter	a) 28" b) 26"	a) 34 1/2" b) With 3" wear diameter
Standard track gauge	4'-8 1/2"	4'-8 1/2"

~~E. Passenger Capacities~~

<del>Passenger Capacities</del>	<del>Light Rail Vehicle</del>	<del>Heavy Rail Vehicle</del>
<del>Seated</del>	<del>66 minimum two seats each end of car shall be folded up to provide space for on wheel chair passenger at each end of each car</del>	<del>61</del>
<del>Standing</del>	<del>Service Load—109 Full Load—164 Crush Load—218</del>	<del>Service Load—180 Crush Load—301</del>

~~F. Vehicle Weight and Design Loading~~

<del>Vehicle Weight and Design Loading</del>	<del>Light Rail Vehicle</del>	<del>Heavy Rail Vehicle</del>
<del>AWO Maximum empty car operating weight</del>	<del>98,000 pounds</del>	<del>80,000 pounds</del>
<del>AW1 Seated load car weight</del>	<del>110,000 pounds</del>	<del>89,000 pounds</del>
<del>AW2 Service load car weight</del>	<del>126,000 pounds</del>	<del>108,000 pounds</del>
<del>AW3 Full load car weight</del>	<del>135,000 pounds</del>  <del>Not to exceed 1,600 pounds per foot of length. The maximum AW3 weight shall not exceed 135,000 pounds, regardless of length (Reference Figure 9.1)</del>	<del>126,000 pounds</del>

~~GI. Vehicle Static and Dynamic Envelopes~~

- ~~The static and dynamic envelope shall be as defined in Section 4 and must follow the California Public Utilities Commission (CPUC) General Order No. 24-D (CLERANCES ON RAILROADS & STREETS RAILROADS WITH REFERENCE TO SIDE AND OVERHEAD STRUCTURES, PARALLEL TRACKS, CROSSING OF PUBLIC ROADS, HIGHWAYS AND STREETS) or later revision if any.~~

~~HJ. Vehicle Performance~~

- ~~Speed Vehicle performance envelope parameters shall be coordinated with the requirements of the operating line associated signal previously procured equipment and other system design.~~

Light Rail Vehicle  
Operating Speed  
65 MPH maximum

Heavy Rail Vehicle  
70 MHP maximum

- Acceleration  
Light Rail Vehicle  
Nominal initial 3.0 MPHPS  $\pm$  5% for car weights AW-0 to AW2

Heavy Rail Vehicle  
Nominal initial rate 3.0 MPHPS  $\pm$  5% for car weight AW0 to AW2

- Braking  
Light Rail Vehicle  
~~AWO to Full Load – In accordance with CPUC G.O. 143A, 4.03 listed in Table 9.1 for manual operation.~~

Heavy Rail Vehicle  
~~AWO to AW3 3.0 mphps  $\pm$  7%~~

**Emergency Brake**

**For Heavy and Light Rail:**

At any given entry speed below overspeed limit, the emergency brake rates shall be within the range specified (Table 9.3.44) and shall be calculated by averaging the average deceleration rates (v/t) from several stops made in opposite directions on the same section of dry, level tangent track for all conditions of loading (AWO to Full Load). The velocity (v) is the velocity that exists after the maximum mode change dead time has elapsed and the brake rate has increased to the command value. The time (t) is the elapsed time from the point where velocity has attained a value equal to "v" until the car has stopped.

**TABLE 9.3.54  
BRAKING RATES FOR LIGHT RAIL VEHICLE**

Braking Entry Speed (MPH)	Average Deceleration Rate (MPHPS)	
	Service Braking	Emergency Braking
55 or more	2.7	4.5
45	2.6	5.2
35	2.5	4.5
25	2.3	4.5
20 OR less	2.2	3.5

Service Brake

Light Rail Vehicle – AW0 to Full load 3.5 mphs

Heavy Rail Vehicle – AW0 to Full load 3.0 mphs

Hi-Rail Maintenance Vehicle Design Loading

- Refer to Section 4 for loading parameters.

Braking Entry Speed (MPH)	Average Deceleration Rate (MPHPS)		
	Service Braking System	Dynamic Brakes Cutout	Emergency Braking System
55 or more	2.7	1.9	4.5
45	2.6	2.0	5.2
35	2.5	2.0	4.5
25	2.3	2.1	4.5
20 OR less	2.2	2.2	3.5

I. Vehicle Doors

There shall be an appropriate number of door openings per car side to permit passenger movement between the car and the platform. Paragraph 9.3.2.A identifies the door configuration that has been selected for the current operation.

1. Door controls shall be trainlined to permit the operator to open and close all doors on either side from the operating cab. Door controls for each side shall be independent. The operator's door control switches shall be toward the same side of the cab as the doors being opened.
2. Door control circuitry shall be designed to preclude un-commanded opening of doors.
3. Operation of one car door on each car side shall be possible from both the inside and the outside of the car by means of a keyed crew switch. Entry to the operator's space shall be by key whether via internal or external means.
4. The door apparatus shall include a passenger activated door emergency release capability. Operation of this device shall initiate a full service stop.
5. Each door leaf shall be equipped with a positive mechanical locking feature which shall prevent the door leaf from being manually pushed open when the train is moving.

- ~~6. A sealed traction interlock bypass switch shall be provided in the operator cab to permit movement of the train in the event of side door interlock circuit failure.~~
- ~~7. Door leaf closure detection shall be provided on each door leaf and shall be interlocked with ATP to prevent operation of the train without a "door closed" indication from all door leaves.~~
- ~~8. The side door edges shall not exercise a force of more than 25 pounds on a 4-inch diameter cylinder inserted perpendicularly to door travel.~~
- ~~9. The door control circuit shall momentarily interrupt door closure when an obstruction is met.~~
- ~~10. Patrons shall be alerted when doors are ready to close. An audible sound and flashing visual warning shall occur inside the vehicles before the doors begin to close.~~
- ~~11. In emergencies, manual release of side doors shall be provided as follows:
  - ~~a. Interior manual side door controls shall be provided for use by the patrons.~~
  - ~~b. Exterior manual side door controls shall be provided for one door per side and be adequately labeled.~~
  - ~~c. Interior emergency releases shall be provided to indicate door is open or unlocked.~~~~

#### ~~12. Door Width~~

~~Side door openings shall be wide enough to permit use by patrons in wheelchairs. See Paragraph 9.3.2.e~~

#### ~~J. Windows~~

~~Glazing shall be installed to permit operator visibility, allow passengers to observe the platform and to see between cars in multi-car consists. The following provisions shall be made to mitigate hazards caused by objects striking and shattering or penetrating windshields, side windows, and cab windows:~~

~~The windshields and F-end (the end of a passenger vehicle containing the operator cab) door windows shall be certified to comply with the requirements of ANSI Z26.1, Table 1, Item 1, and pass the following test requirements when installed:~~

- ~~1. ANSI Z26.1, Test 8, Impact, using shot bag dropped from a height of 15 feet.~~
- ~~2. ANSI Z26.1, Test 26, Penetration Resistance, modified to include entire windshield assembly, simulating the impact of a one-pound ball at 80 miles/hour and the impact of a five-pound ball at 50 miles/hour.~~

- ~~3. If tinting of the operator's windows is provided, it shall meet the light transmission standards of the California Vehicle Code.~~

~~Side windows, cab side windows, side door windows, and R-end (the end of a passenger vehicle that does not contain the operator cab) door and end windows shall be certified to comply with the requirements of ANSI Z26.1, Table 1, Item 3. Side windows shall be quick release installation. Cab door windows (to passenger area) shall be certified to comply with the requirements of ANSI Z26.1, Table 1, Item 1.~~

#### ~~K. Interior Design Features~~

~~The vehicles shall include comfortable passenger seats of durable, vandal-resistant materials in a configuration that will allow efficient use of the vehicle's space and rapid passenger loading and unloading. Seating elements most subject to heavy wear and essential to comfort shall be of modular design for ease of replacement. Module removal shall be with use of special tools. Seat backs shall have grips for safety and to assist in sitting and rising. Additionally handholds and stanchions shall be provided for safe passenger boarding, circulation, and standing.~~

~~Seating and vehicle access shall be in accordance with all rules and regulations of the Americans with Disabilities Act (ADA). Reference Provisions for Individuals with Disabilities requirements.~~

~~Seating and standing arrangements shall enable patrons to move easily and safely within a moving or stopped vehicle.~~

- ~~1. Human factors considerations shall be applied in the design of the physical features, including the passenger and operator seats and the cab and console layout.~~
- ~~2. Sharp edges and protrusions shall not be permitted.~~
- ~~3. Protective cushioning shall be provided on seats as appropriate.~~
- ~~4. Within each car, a location shall be identified for a wheelchair which will not interfere with the other patrons' movements.~~
- ~~5. Windscreens shall be provided at each side door opening with the exception that a windscreen need not be provided at the wheelchair location.~~
- ~~6. Stanchions shall be provided.~~
- ~~7. Padded handholds and handrails shall be provided as part of the transverse seats.~~
- ~~8. Priority seating graphics shall be provided in each vehicle near designated seating.~~



**LK. Communications**

On-board communications shall be provided as follows:

- ~~• Each vehicle shall be provided with a patron intercom (IC) system to permit communication between a patron and the train operator. The IC shall be suitably protected from vandalism.~~
- Communications capability between ROC and the train operator and from/to on-board patrons shall be provided **by a combination of on-board intercom (IC) and the train-borne two-way radio system.**
- All vehicles shall be numbered uniquely to provide for positive identification. **The train-borne two-way radio shall transmit the train identification each time the train-borne radio is used to transmit.**
- Operating instructions and vehicle number shall be applied to the sidewall immediately below each remote IC station on each vehicle. **There shall be a minimum of four IC per train car.**
- Emergency communication capabilities, **including train operator radio, Digital Video Recorders, the associated cameras, the associated cab microphone, and IC system,** for the vehicle shall be provided with a battery backup power system **that has a minimum capacity of 4 hours of run time with the assumption of 50% transmission time of the two-way radio.**
- **Wireless communication of vehicle data (DVR and diagnostics) will be incorporated into future vehicles via 802.11 type of wireless technologies. The train-borne two-way radio system that is used for voice communications shall not be used for this type of data transmission.**
- ~~• The vehicle intercom operating controls, positions and locations shall be readily accessible to, and operable by, elderly and handicapped patrons.~~
- ~~• Each vehicle shall be provided with a visual, exterior signal to indicate the specific vehicle in a consist in which the IC has been activated.~~

**M. Cab Controls/Indicators**

~~Safety-critical malfunctions and failures, and conditions or vehicle systems that could affect the safety of the vehicle or the passengers, shall be detected and annunciated. As a minimum, these shall include:~~

- ~~• Actual train speed indication~~
- ~~• Power/propulsion failures~~
- ~~• Door open/door close signals~~
- ~~• Braking failures/malfunction (electric and friction)~~
- ~~• Speed limits in cab signal territory~~
- ~~• Enabling of bypass selection or system cutouts.~~

~~The train controller shall be equipped with "deadman" or equivalent capability for use in the manual mode of operation.~~

~~The Master Key switch shall be provided that is interlocked such that only the controller at the front of the lead vehicle of a multi-vehicle train is operable.~~

#### ~~N. Signaling (LRT)~~

~~Signaling for the LRT is discussed here in Section 9.3 because so much of LRT vehicle operation is closely related to signaling. Signal and ATC criteria for all the systems are presented in Section 9.4.~~

~~The signaling system utilized by the LRT Projects shall comply with the provisions of CPUC General Order 143 B.~~

~~Speed Permitted on Pedestrian Malls - Rail vehicle operation located on a promenade, pedestrian walk, open or covered passageway, concourse, mall or other public area closed permanently or at stated times to motor vehicles, rail vehicles and trains may operate at speeds not to exceed 20 mph unless otherwise restricted in accordance with CPUC GO 143 B, Table 1.~~

~~Speed Maximum of 35 mph - Rail vehicle operations located upon a street or highway also handling motor vehicle traffic may operate at lesser of a speed not to exceed 35 mph or the speed permitted by the local Vehicle Code for motor vehicle traffic, in accordance with CPUC GO 143 B, Table 1.~~

~~Speed Maximum of 45 mph - Rail vehicle operations located on private right-of-way which may include at-grade crossings over which motor vehicle traffic is controlled by automatic crossing gate signals and pedestrian traffic is controlled by automatic crossing signals; rail operations not governed or controlled by a continuous train control, or automatic block signal system may operate at a speed not to exceed 45 mph in accordance with CPUC GO 143 B, Table 1.~~

~~Speed Maximum of 55 mph - Rail vehicle operations located on private right-of-way, which may include at-grade crossing over which motor vehicle traffic is controlled by automatic crossing gate signals and pedestrian traffic that is controlled by automatic warning signals, may operate at speeds not to exceed 60 mph, provided that all vehicles and trains are governed or controlled by a signal system in accordance with CPUC GO 143 B, Table 1.~~

~~Crossing of Railroad Tracks At-Grade - Rail vehicle operations over a crossing of railroad at-grade shall be governed and controlled by an automatic interlocking installation constructed, maintained, and operated pursuant to Sections 20 through 23 of CPUC General Order No. 33B, except at a railroad grade crossing which has been exempted from this requirement by the CPUC.~~

~~Design of Signal Control Apparatus and Circuits - Signal Control Apparatus and circuits shall be designed to meet the following:~~

- ~~1. All components shall be combined in such a manner that a restrictive (rather than Permissive) condition results from a component failure.~~

- ~~2. All components shall be reliable and have predictable failure modes in accordance with System Assurance Section of this document. (See Design Criteria Section 12.)~~
- ~~3. All control circuits shall be designed on the closed circuit principle where circuits interrupted or de-energized will cause the controlled function to assume its most restrictive condition.~~
- ~~4. All circuits not totally within a single apparatus enclosure shall have double-wire, double-break control.~~
- ~~5. Isolation shall be provided between all circuits and sources other than those intended for the circuit to prevent a flow of current of more than 50% of the release value of any relay or other safety device used in the circuit.~~
- ~~6. No fuses or circuit breakers that would impact circuit functions shall be allowed internal to those circuits.~~
- ~~7. Circuit breakers status shall be annunciated.~~

#### ~~O. Power/Propulsion~~

~~Normal or abnormal/emergency conditions or operations shall not result in unsafe conditions.~~

~~The manual controller shall have a "deadman" or equivalent capability in the manual mode.~~

~~The mode selection switch and the manual controller shall be interlocked to assure that the manual controller's capability is locked out from the mode selection switch in the "Automatic" or "Off" position.~~

~~A current collector/contact rail isolation device, suitable for on-board vehicle storage shall be provided.~~

#### ~~P. Braking~~

~~Emergency brake control shall be fail-safe to the extent that no single failure or series of common mode or common cause failures can result in less than 75% of emergency braking effort per train consist being available.~~

~~When the safety-critical emergency stop circuit is activated, the P-signal and BRK-signal circuits and the traction power line breaker shall be opened. The emergency stop circuit shall ensure an irretrievable stop after an emergency application is initiated and ensure that the train is brought to zero speed before it can proceed in any mode of operation.~~

~~There shall be redundant methods of automatically/manually applying emergency braking.~~

~~An emergency stop button shall be provided that when activated from any console on a consist applies full emergency brakes. Spin/slide design shall be such that a failure does not inhibit application of emergency brakes. Cutouts and system bypass selections shall be provided for dynamic functions that, upon failure or malfunction, interrupt normal train operations. When ATP is bypassed, an external light, visible from the platform, shall be illuminated.~~

~~Where carborne ATC does not provide adequate stopping distance to fixed objects and where unprotected manual train operations are routinely utilized, trip stops shall be used to provide safe stopping.~~

#### ~~Q. Auxiliary Electrical~~

~~Failures or malfunctions shall not result in unsafe operations or conditions.~~

~~Approved protection shall be provided against short circuits and overloads.~~

~~High voltage circuits shall be provided with appropriate identifications in accordance with transit industry standards and codes.~~

~~High voltage circuitry shall be physically separated from communications circuitry and low voltage control circuitry.~~

~~HVAC temperature and overload sensors and annunciators shall be provided.~~

#### ~~R. Other Design Features~~

~~The following other features shall be included:~~

- ~~1. Anticlimbers and collision posts shall be located at each end of the vehicle.~~
- ~~2. Patron emergency instructions shall be placed in each vehicle.~~
- ~~3. Emergency equipment to aid in evacuating the vehicle shall be located within the vehicle.~~
- ~~4. Fire extinguishers shall be provided in accordance with Fire/Life Safety Criteria.~~
- ~~5. Exterior lighting shall include vehicle headlights and taillights.~~
- ~~6. The capability for remote uncoupling from within the vehicle shall be provided.~~
- ~~7. A safe method of externally uncoupling vehicles shall be provided.~~
- ~~8. Locations of fire extinguishers, patron intercoms, and door releases shall be clearly marked.~~

- ~~9. Vehicle electrical, electromechanical, hydraulic and mechanical system designs shall use approved redundancy, fail-safe or fail-operational principles.~~
- ~~10. Restraining devices shall be provided to secure the truck to the carbody.~~
- ~~11. Provisions shall be made to electrically and pneumatically isolate a vehicle that has an operational malfunction, such as inoperative brakes or inoperable traction devices, from the remainder of the vehicles within that consist.~~

~~S. Internal Climate Control~~

~~Rail Vehicles shall be provided with an automatic comfort control system to maintain a comfortable interior temperature under normal external environmental conditions with or without variable internal heat loads, such as passengers, motors, lights or solar gain.~~

~~T. Air Comfort System~~

~~An air comfort system shall utilize ventilation, heating and cooling modes to automatically maintain the following vehicle interior air temperatures:~~

~~**Ambient Temperature: Ta Interior Temperature: Ti**~~

~~$Ta < 40^{\circ}F \text{ ----- } Ti \geq (Ta + 28^{\circ}F)$~~

~~$40 \text{ degrees } F \leq Ta < 60^{\circ}F \text{ ----- } 68^{\circ}F \leq Ti \leq 75^{\circ}F$~~

~~$60 \text{ degrees } F \leq Ta < 89^{\circ}F \text{ ----- } 68^{\circ}F \leq Ti \leq 72^{\circ}F$   
(Interior conditions requiring reheat)~~

~~$60 \text{ degrees } F \leq Ta \leq 89^{\circ}F \text{ ----- } 72^{\circ}F \leq Ti \leq 75^{\circ}F$   
(Interior conditions not requiring reheat)~~

~~$89^{\circ}F < TA \leq 100^{\circ}F \text{ ----- } Ti \leq (Ta - 14^{\circ}F)$~~

~~$100^{\circ}F \leq Ta \text{ ----- } \text{As the system will provide}$~~

~~Maximum interior relative humidity shall not exceed 55%. Maximum air velocity throughout the car 48 inches above the floor shall be 50 ft. per minute (fpm).~~

~~U. Lighting~~

~~Interior lighting shall be of a uniform level that provides for reading comfort and safety of the patrons and vehicle operator. Lighting shall be designed to be glare free and utilize long-life, low-power consumption lamps. Emergency lighting shall be provided so that patrons can see adequately during vehicle emergency evacuation in accordance with CPU G.O. 143-B, 5.03, 5.04, 5.05.~~

~~Interior lighting levels shall be consistent with APTA's "Transit Security Guidelines Manual" of 30 or more footcandles as required.~~

~~All floors at exits shall be entirely illuminated, without shadows. The lighting intensity of the surface of the top tread shall not be less than five foot-candles as required by CPUC General Order 143-B.~~

~~Emergency lighting shall be provided and powered by a battery backup system. The minimum illuminance level and duration of lighting at floor level shall be one foot candle for one hour.~~

#### ~~V. Ride Quality~~

~~Vehicles shall be designed to be free from objectionable vibration and shock. All equipment mounted in the passenger area shall be free from resonance to avoid annoying audible and visual distraction.~~

~~The ride quality shall be evaluated according to ISO 2631. The rms acceleration values shall comply with, "reduced comfort level" boundaries derived from Figure 2a (vertical) and Figure 3a (horizontal) of ISO 2631-1987 (E) as specified in individual procurement specifications.~~

#### ~~W. Noise~~

~~Average noise levels emanating from a married pair or a single articulated car shall not exceed the following levels (with all auxiliary equipment operating simultaneously) at a distance of 50 feet from each side of the car at 5 feet above ground plane using fast meter response.~~

~~1. Vehicle Stationary Empty: 65 dBA~~

~~2. Vehicle empty, on tangent track, and accelerating from 0 to 40 MPH, or maximum electric braking or maximum friction braking from 40 MPH (whichever is worse): 77dBA~~

~~Equipment that operates for durations of less than two seconds, such as dump valves or contractors shall not exceed 85 DBA when measured 16 feet from car centerline using the fast meter response.~~

~~The interior noise level of the vehicle in motion and with all subsystems operating shall not exceed 72 dBA. For the stationary vehicle, the interior noise level for similar conditions shall not exceed 68 dBA.~~

#### ~~X. Climate~~

~~The vehicles shall be capable of being operated at the specified performance levels, and stored/maintained without temporary or long-term impairment resulting from natural or induced environments in which the Authority intends to operate the vehicle.~~

~~Refer to Section 2, Environmental Considerations for environmental factors to be used as design guidelines.~~

~~Y. Lighting~~

~~External lighting on light rail vehicles shall be in accordance with CPU G.O. 143 B, 5.01 and 5.02.~~

~~Operations at higher speeds, or on curves, will produce higher sound levels.~~



**FIGURE 9.1**  
**LIGHT RAIL VEHICLE DIMENSIONS AND DESIGN LOADING**

**FIGURE 9.1**  
**LIGHT RAIL VEHICLE DIMENSIONS AND DESIGN LOADING**

**NOTES:**

- ~~1. The vehicle dimensions specified reflect either acceptable ranges or lengths tolerable.~~
- ~~2. The maximum allowable P-1 axle weight under AW3 loading shall not exceed 23,290 pounds.~~
- ~~3. The maximum allowable P-2 axle weight shall conform to the limitations specified as follows:~~

~~A. Weights and Capacities~~

~~The vehicle weight and weight distribution is limited by, and shall conform to, existing Caltrans bridge structure loading criteria. The criteria are structure-specific and cannot be precisely stated.~~

~~Passenger weight shall be assumed to be 154 pounds per person.~~

~~B. Weight Distribution~~

~~Vehicle weight distribution shall be maximize adhesion and minimize tendency to derail for all passenger loadings.~~

~~The weight exerted by the center truck shall be between 24% to 31% of the total weight on rail.~~

~~Weight distribution between end trucks shall not differ by more than 2000 pounds.~~

~~Lateral imbalance shall not exceed 25,000 inch-pounds at AWt.~~

- ~~4. The total vehicle weight under AW3 loading shall not exceed 1,600 pounds per foot of length. The maximum AW3 vehicle weight shall not exceed 135,000 pounds, regardless of length.~~
- ~~5. Upper limit of dimension "B" shall be 46.5 feet (measured over coupler faces). The vehicle shall meet all clearance requirements under the worst conditions.~~
- ~~6. All dimensions are in feet.~~

**HEAVY RAIL VEHICLE DIMENSIONS AND DESIGN LOADING**

## NOTES:

1. ~~The vehicle dimensions specified reflect either acceptable ranges or lengths tolerable.~~

2. ~~Weight and Capacities~~

~~The vehicle weight distribution is limited by, and shall conform to existing Caltrans bridge structure loading criteria. The criteria are structure-specific and cannot be concisely stated.~~

~~Passenger weight shall be assumed to be 154 pounds per person.~~

~~A. Weight Distribution~~

~~Vehicle weight distribution shall maximize adhesion and minimize tendency to derail for all passenger loadings.~~

~~B. Weight Requirement~~

~~The A or B car Aw\* weight (normal 80,000 lb) shall be confirmed by actual measured and certified weight at shipment including Metro and Contractor furnished carborne equipment.~~

~~C. Maximum Weight Difference~~

~~The maximum permitted AW\* Weight difference between an A and B car shall be no greater than 1,500 lb. Location of shared equipment for A and B car shall be Contractor's responsibility, unless otherwise specified.~~

~~At AW\*, the weight measured under each truck of a single vehicle shall not be less than 49 percent of the actual total vehicle weight. The weight measured on each side of the longitudinal centerline of an AW\* vehicle shall not be less than 49 percent of the actual AW\* vehicle weight.~~

~~Weights of delivered A and B cars shall be within  $\pm 400$  lb of their respective average final AW\* vehicle weights.~~

3. ~~All Dimensions are in Feet and Inches.~~

## 9.4 TRAIN CONTROL

### 9.4.1 Description

#### 9.4.1.1 Description

The 9.4 article serves to establish the basic design criteria for the signaling automatic train control (ATC) system, circuits and equipment required for safe vehicle operation for expansion as well as new line construction for Light Rail Transit (LRT) and Heavy Rail Transit (HRT) systems.

#### 9.4.1.2 Applicable Standards and Reference Documents

- A. All apparatus and work included in the design, manufacture, and installation of the ATC System shall conform to current relevant specifications and recommendations by the following agencies or organizations:
1. American Railway Engineering and Maintenance of Way Association (AREMA)
  2. American National Standards Institute (ANSI)
  3. American Public Transit Association (APTA)
  4. Electronic Industries Alliance (EIA)
  5. Federal Communications Commission (FCC)
  6. Federal Railroad Administration (FRA)
  7. Federal Transportation Administration (FTA)
  8. Institute of Electrical and Electronics Engineers (IEEE)
  9. National Electrical Code (NEC)
  10. National Electrical Manufacturers Association (NEMA)
  11. National Fire Protection Association (NFPA)
  12. Public Utilities Commission of the State of California (PUC) General Orders
  13. Title 8 of the California Code of Regulations (CCR)
  14. U.S. Government Code of Federal Regulations and Military Standards.
  15. U.S. Department of Transportation Manual of Uniform Traffic Control Devices (MUTCD) part VIII.

#### 9.4.1.3 Function Requirements

The ATC system shall be designed to address train safety, control train operations, and direct train movements on the main line and in the yard. System design objectives shall be safety, operational efficiency, cost effectiveness, and upgradeability.

A. System Configuration

The ATC system is to be comprised of four major subsystems:

1. Automatic Train Protection (ATP)

An Automatic Train Protection subsystem shall maintain safe train operation by enforcing speed restrictions. Speed restrictions shall be enforced by comparing the actual speed of the train with maximum allowable speeds derived from braking distance formulas and civil restrictions. Speeds shall be transmitted to the train through track circuits or wire loops, from wayside

equipment. Detection of an overspeed shall force the train into service or emergency braking to maintain safe train operation.

2. Automatic Train Supervision (ATS)

An Automatic Train Supervision system shall control and direct train movements on the main line and in the yard. The ATS system monitors train operation and provides controls, indications, automatic route initiation, and automatic dispatching necessary to maintain intended traffic patterns to minimize the effect of train delays on the operations schedule.

ATS is an integral part of Rail Operations Control (ROC). ROC will contain the necessary displays, control consoles, communications apparatus, and the operating personnel responsible for the overall safety and security of passengers and for the daily operations of the trains, stations, and all supporting apparatus. The ROC will serve as the focal point from which all Rail System operations will be supervised.

3. Highway Crossing Warning System (HCWS)

HCWS shall provide an interface between the wayside signal equipment and the crossing warning devices, such that flashing lights and gates are controlled to provide timely information of and protection from an approaching train.

4. Train to Wayside Communication System (TWC)

That function whereby trains can communicate information between the vehicle equipment and wayside interrogators at appropriate points along the route such as:

- Vehicle identification
- Routing information
- Establish routes
- Cancel routes
- Activate or deactivate HCWS

B. System Expansion

1. ATC subsystems shall be developed as a "Building Block" design including hardware and software design provisions for expansion of the system with minimal modification to hardware, software and facilities of the systems being installed.
2. ATS shall include automatic routing capabilities based on train identification/destination to accommodate future routes for automated lines.
3. Application logic shall be free from unnecessary complexities and well commented such that an experienced train control designer can follow the logic.
4. All non-COTS (Commercial Off the Shelf) software and application logic shall be provided to enable future maintenance and modification.

### C. Operational Considerations

In design and implementation of the ATC system, the following operational considerations shall apply:

1. The ATC system shall provide for minimal degradation of service under certain definable anomalous scenarios. These scenarios shall include, but not be limited to: utility power loss, vehicle equipment malfunctions and ROC operating malfunctions. Bi-directional single-track operation shall enable service around unusable sections of track.
2. Train operations in the reverse direction of traffic shall be done with vehicles with fully functional Automatic Train Protection systems.
3. Interlockings shall enable trains to turn back and / or operate on a single track.
4. Train locations and movements throughout the main line shall be displayed at ROC.
5. All movements of trains between yard tracks and main line tracks shall be coordinated by Yard Controllers and ROC dispatchers, or local control panel operators and ROC Controller.
6. Trains shall be able to clear and release mainline tracks, prior to entering yard territory.

### D. Performance Requirements

The ATC system shall be designed to address train safety, control train operations, and direct train movements, with the highest practicable levels of safety and service. The ATC system shall optimize reliability and maintainability for efficiency of operation and cost effectiveness. The system shall include the following:

1. A block design based on the maximum allowable speeds consistent with track alignment and other speed restriction requirements.
2. Reverse running capability with ATP on each track, with following move capability.
3. Entry of trains into main line service, with ATP, from any station, terminal, or yard.
4. The capability of aligning any non-conflicting route, controlling traffic, and performing control functions from ROC or local control panels and the TWC equipment when neither ROC or local control is in control.
5. Display of all information relative to train operations, including the position and identification of trains, route alignment, and traffic direction.

6. Centralized control from a control console capable of controlling all functions for each main line interlocking, as required, and displaying all indications and trouble alarms necessary for system control and supervision.
7. Automatic or Fleet routing at interlockings.
8. Enforcement of tunnel ventilation zones, which restricts the quantity of trains within a zone.

Main line train control shall be governed by cab signaling, with wayside signals provided at interlockings and at other locations as required by Metro Rail Operations.

The main line includes a combination of double track and multiple track railroad, which shall be signal controlled to provide safe train separation. Operations on the main line shall run with either automatic routing or fleeting. Manual route setting shall be provided via Train-to-Wayside Communication (TWC), accessible from the Rail Vehicle cab. Manual route setting shall also be possible from the Local Control Panel (LCP) provided in each signal house and from Rail Operations Control (ROC) via SCADA.

#### **9.4.2 Metro Gold Line Expansion and Any New Construction**

##### **9.4.2.1 General Requirements**

The signaling system shall provide the following functions:

- Interlocking control of switches and signals
- Safe routing of trains
- Safe separation of trains to prevent collisions and side swipes by physically separated operation on the main line, protected by vital systems
- Protection of highway crossings against road/rail collisions giving railroad traffic priority by provision of highway crossing warning and protection systems and interfaces with highway traffic control equipment

The signaling system and grade crossings shall comply with the AREMA Manual of Recommended Practices - Signals and CPUC General Orders 75, and 143.

Automatic route setting shall be for normal train operation. Manual selection of routes shall be provided for abnormal train operation or when automatic routing is not desirable.

Bi-directional operation at full line speed and headway shall be provided throughout the main line. All sections under signal control shall be signaled such that, in the event either of the tracks in the double track sections is taken out of service, safe operations can be maintained.

The signal system shall provide continuous overspeed protection and speed commands (cab signal) operation, which shall prevent unsafe operation with respect to other trains, interlocking conditions, civil speed limits, and grade crossings.

Any transition from street running to cab signal territory shall be governed by a wayside



signal. Overrun of such signal displaying STOP aspect shall trigger automatic brake application.

The cab signal system shall impose speed restrictions due to civil/track speed limits. In the normal direction of traffic the following design requirements shall be followed:

- The speed code reduction shall occur at a point no further than 110% of the Civil Braking Distance from the point of restriction.
- The cab signal and block design shall enable acceleration to the authorized speed (within safe braking constraints) to commence within 400 feet of the end of the speed restriction area.
- The maximum block length shall be 5,000 feet.
- All track circuits with a Maximum Authorized speed (MAS) exceeding 35 mph shall have at least one intermediate speed code before "STOP".
- All track circuits shall have a provision to allow for a manual downgrade to a more restrictive speed code via local control panel or hardware cards. Manual speed code selection shall not override safe train separation function of ATP.
- Exceptions to the above criteria shall be reviewed on a case-by-case basis.

The cab signal system shall impose speed restrictions on the approach to stations with an at-grade crossing on the exit side of the station. In the normal direction of traffic the following design requirements shall be followed:

- Speed code reduction, or removal of cab code shall occur on the approach to, or the exit from, the station to ensure that a train that fails to make a station stop, or does not make a full 20-second dwell, cannot enter the crossing unless the entrance gates are fully down.
- Speed code reduction, or removal of cab code shall, never-the-less, maximize the train speed into the station.
- Speed code reductions shall be calculated using the Civil Braking Distance formula.
- Speed code reductions shall occur at a point no further than 120% of the Civil Braking Distance from the near side of the crossing.
- Crossings shall be activated automatically, assuming a 20-second station dwell. Once the entrance gates are down, full speed cab code shall be available.
- Where the crossing is within 100 feet of the station, a TWC system shall be provided to enable crossing calls to be called or cancelled.

#### **9.4.2.2 Safe Braking Distance Model**

##### **9.4.2.2.1 Introduction**

The Safe Braking Distance (SBD) is the calculated distance that a worst-case train will travel between the time that a speed reduction is commanded until the required speed reduction is achieved. The train operator is in control of the speed with the cab signal system providing over-speed protection only. The design shall utilize the SBD formula for all safety braking requirements.

The Civil Braking Distance (CBD) is the calculated distance that a train will travel between the time that a civil speed reduction is commanded until the required speed reduction is achieved. The train operator is in control of the speed with the cab signal system providing over-speed protection only. The CBD formula shall not be applied to safe train separation.

**9.4.2.2.2 Initial Entry Speed**

For SBD and CBD calculations, an initial entry speed (S) is used, which is derived from a combination of Cab Signal Speed (CSS), Cab Signal Tolerance (CST), Cab Signal Overspeed Allowance (CSO), and the Acceleration Allowance (AA) as follows (all values are mph unless specified otherwise):

CSS = 55, 45, 35, 25, 15, 10, or 0 mph according to the cab signal code immediately prior to entry.

CST = Tolerance in speed detection, which shall be as follows:

CSS	55	45	35	25	15	10	0
CST	+0, -1.5	+0, -1.5	+0, -1	+0, -1	+0, -1	+0, -1	+1, -1

CSO = Allowable exceedance of cab signal speed as detected by the carborne cab signal system, which shall be as follows:

CSS	55	45	35	25	15	10	0
CSO	2	2	3	3	3	3	2.5

AA = An allowance to account for instantaneous acceleration of the vehicle for the time delay between the decoding of the speed code by the carborne equipment, and removal of propulsion power. The allowance shall also include for jerk-limited removal of power and application of braking.

For SBD calculations,  $S = CSS + CST + CSO + AA$

For CBD calculations,  $S = CSS + CST + CSO$

**9.4.2.2.3 Safe Braking Distance Calculation**

$SBD = D_r + D_b + D_o$ , where:

$D_r =$  Reaction distance in feet =  $S \times R \times 1.467$

$D_b =$  Braking Distance in feet =  $0.733 \times S^2 / (B \pm 0.2G)$

$D_o =$  Overhang distance of two vehicles = 30 feet

S = Initial entry speed (mph) prior to braking.

R = Reaction time in seconds (includes operator, cab signal delays and brake build-up) = 9.8 seconds for a change in speed code and 7.2 seconds for code-to-no code.

B = Safe Braking rate = 2.0 mphps

G = Alignment grade as a decimal fraction

For safe braking calculations to bumping posts, the overhang distance of one vehicle (15 feet) can be used for distance  $D_o$ .

**9.4.2.2.4 Civil Braking Distance Calculation**

CBD =  $D_r + D_b$ , where:

$D_r$  = Reaction distance in feet = (CSS) x R x 1.467

$D_b$  = Braking Distance in feet =  $0.733 \times (CSS^2 - V^2) / (B \pm 0.2G)$

CSS = Cab Signal Speed (mph) prior to braking.

V = Target speed at speed restriction

R = Reaction time in seconds (includes operator, cab signal delays and brake build-up) = 4.0 seconds.

B = Safe Braking rate = 2.0 mphps

G = Alignment grade as a decimal fraction

The target point for achieving the speed reduction shall be the tangent-to-spiral point on curves and the point of switch for turnouts.

Civil speed restrictions shall be maintained until the rear of the train is clear of the restriction. For curves, this shall be the curve-to-spiral point.

**9.4.2.3 Cab Signal System**

**Functionality Overview**

The cab signal received on-board the car shall be interpreted as a speed limit, the aspect of which, shall be displayed to the operator.

Code rates and their meanings shall be:

<b>CODE RATE</b>	<b>INDICATION</b>
410 PPM (6.83 Hz)	Cab signal cutout. Used for Street Running mode (35 mph speed limit).
270 PPM (4.5 Hz)	Proceed at 55 mph.
180 PPM (3 Hz)	Proceed at 45 mph.
120 PPM (2 Hz)	Proceed at 35 mph.
75 PPM (1.25 Hz)	Proceed at 25 mph.
50 PPM (0.833 Hz) @ 100Hz, asynchronously combined with 50	Proceed at 15 mph.

PPM (0.833 Hz) @ 250Hz	
50 PPM (0.833 Hz)	Restricted (Yard). Proceed at maximum of 10 mph, prepared to stop.
Unmodulated 100 Hz	Stop
No Code	Stop and Proceed. Approaching a signal at stop or when occupancy exists ahead that requires immediate brake application to safely avoid a collision.

The cab signal rail current shall be no less than 3 amps at the entering end of track circuits and the feed end shall be no greater than 20 amps.

The carrier frequency shall be 100 Hz ±2 Hz.

The code rate tolerance shall be ±5%.

The code duty cycle shall be 60/40 to 40/60.

Dead sections, such as at insulated rail joints, shall be no greater than 14 feet in length.

Use pre-cab, as necessary, to ensure no momentary loss of cab (cab flip).

**9.4.2.4 Train-to-Wayside Communication**

The Train-to-Wayside Communication (TWC) system shall be compatible with Hanning & Kahl HCS-V.

TWC transponders shall be provided at the following minimum locations:

- Approach to all wayside signals
- At stations with near-side at-grade crossings
- At the terminus station (for calling of a route onto the main line)

**9.4.2.5 Train Detection**

The signaling system shall detect all cars operating independently or in consist, and any other rail vehicle present, except hi-rail vehicles.

The presence of a rail vehicle in a section of the route shall be detected continuously by means of track circuits.

Detection of the occupation of the track circuit shall be fail-safe, such that a de-energized

position is interpreted as an occupation of the track circuit.

In the event of a temporary loss of detection, the design shall ensure that indication of the presence of a rail vehicle in a section will be maintained while a rail vehicle is actually in the section.

If a rail vehicle is parted in an unscheduled manner, the signal system shall ensure that all parts of the rail vehicle are detected. The signal system shall ensure that safe separation is maintained between the parted vehicle and all other rail vehicles.

The minimum effective length of a track circuit shall be longer than the maximum inner wheelbase of all vehicles used on this track.

For track circuits used to control signals and locking functions, including grade crossing activation devices, the minimum shunt sensitivity shall be 0.25 Ohms. The shunting requirements shall be met for ballast conditions of 5 ohms per thousand feet or greater.

#### **9.4.2.6 Broken Rail Detection**

Broken rail detection shall be provided throughout. A broken rail shall de-energize the associated track circuit.

#### **9.4.2.7 Route Setting**

There shall be three methods for control of train movement through the signalized sections, as described below:

##### **9.4.2.7.1 Automatic Route Setting**

Routes shall either normally operate automatically by signal and switch control subsystems responding to the approach of the train, or by use of a Fleet command.

In normal operation, routes shall clear automatically for consists without intervention by the train operator. At terminal stations the train operator shall be able, via TWC, to request that the departing signal be cleared for the train to proceed. Trains shall be normally routed reverse across before reaching the station as the preferred route, or the normal direction route if the preferred platform is occupied.

The ATC system shall use train ID, transmitted by the TWC system, in order to automatically route trains at junctions and turnback points for their designated route.

Fleeting, if implemented, shall be provided for the normal traffic direction only.

##### **9.4.2.7.2 Selection of Routes from the Train**

Train-to-Wayside Communication route selection shall be provided at all interlocking signals.

##### **9.4.2.7.3 Local Route Selection Capability**

Local control capability shall be provided to ensure the safe operation of trains by means of Local Control Panels (LCP) in each signal house.

The LCP shall indicate track circuit occupancy, signal status, switch position and correspondence, switch locking, traffic direction, manual control, automatic control, and crossing gate position, speed restriction enabled, AC alarm, DC alarm, communication failure alarm, system failure (Electrolgixs, VHLC, iVPI, or Microlok), and all indications described in the specifications.

**9.4.2.8 Wayside Signals**

**9.4.2.8.1 Main Line**

LED wayside color signals shall be provided to indicate movement authority, block occupation and route locking information to train operators. Signals shall be installed to govern movements into and through interlocking limits.

Wayside color signals shall show the following aspects, which are in compliance with Metro rules:

<u>Aspect</u>	<u>Meaning</u>
Red	Stop
Flashing Red	Stop and contact ROC. Proceed when authorized by ROC.
Flashing Yellow	Proceed on diverging route into reverse traffic.
Yellow	Proceed on diverging route into normal traffic
Flashing Green	Proceed on normal route into reverse traffic.
Green	Proceed on normal route into normal traffic.

Indication on signals or switches shall be fail-safe, such that no less restrictive aspect is shown than intended.

Wayside signals shall be located such that they are sufficiently visible to preclude confusion with signals governing the operation of motor vehicles, and similarly do not confuse motor vehicle drivers. When viewed from a height of 7 feet above top of rail, at a distance of 500 ft, lenses shall present a distinct aspect under the most adverse operating conditions.

Provide a signal number plate for each signal. The signal number plate shall be placed under the lowest signal lens in the assembly. Signal plates shall meet the requirements of the AREMA Manual of Recommended Practices – Signals. The alphanumeric characters shall be a minimum of 3 inches high.

The top of the top-most aspect shall be set at 5'-5 3/8" above Top of Rail or as approved by Metro.

**9.4.2.8.2 Tunnel Hold**

Provide two-aspect LED wayside signals mounted in the immediate vicinity of a tunnel portal, oriented towards tunnel-bound trains. Signals shall have the following aspects:

<u>Aspect</u>	<u>Meaning</u>
Green	Ventilation zone clear.
Red	Ventilation zone occupied.

Ventilation zone occupancy detection and indication circuits shall be fail safe.

Other requirements for these signals, including sighting distance, construction and circuit requirements shall be as described in 9.4.2.8.1.

**9.4.2.9 Interlockings**

As a minimum, the following locking functions shall be provided for powered switch interlocking:

- a) Switch locking - A locking function shall ensure that a signal governing a switch or combination of switches shall only show a less restrictive aspect than "stop", when all switches are in the correct position.
- b) Automatic Block locking - A home signal governing a block shall only show a less restrictive aspect than "stop", when the entire block is unoccupied by any trains or vehicles. This shall be controlled automatically by means of track circuits throughout the entire block.
- c) Route locking - Route locking shall lock switches within a route after a signal has been requested for train movement onto that route, and shall prevent clearing of opposing and conflicting signals within the interlocking. Route locking shall be in effect when approach locking is in effect, and it shall remain in effect until the rear of the train has cleared the route.

Switches, which are part of the route, and switches or signals, which are protecting against flanking (side-swipe), shall be disabled from moving when the route is locked. Signals protecting this route shall be prevented from showing aspects other than stop.

- d) Approach locking - Approach locking shall lock switches within a route governed by a cleared wayside signal to prevent clearing wayside signals for opposing or conflicting routes.
- e) Time locking - Time locking shall ensure that all switches and signals forming a route, and those protecting it, remain in position and locked for a predetermined time after the entry signal has been caused to display its most restrictive aspect again.
- f) Traffic locking - Setting and locking of a route shall be prohibited unless the opposing signals show the most restrictive aspect. The signal system shall

furthermore prevent any trains simultaneously entering the same block section from different directions or tracks.

Independent of any route locking function, the movement of any powered switch shall be prevented when track occupancy is detected in the track section in which that switch is located.

The switch locking function shall have 5 seconds loss of shunt protection. However, sectional release shall be provided where practicable, to support headways through junctions.

Any failure, including loss of power, to any part of an interlocking shall not result in the premature release of any locking function.

Overrun detection shall be provided for every interlocking signal.

#### **9.4.2.10 Public Highway Crossings**

##### **9.4.2.10.1 General**

Activation of grade crossing warning devices shall be normally achieved by all rail vehicles using the main line, but excluding hi-rail vehicles.

##### **9.4.2.10.2 Highway Crossing Warning Activation**

Warning devices shall normally be automatically activated by the approach of a rail vehicle with a nominally uniform warning time. The devices shall be direction sensitive, and shall be activated by the approach of a train on any track from either direction.

The Crossing Warning time shall be able to be adjusted between a maximum of 30 seconds (or greater if city requirements demand such) and a minimum of 20 seconds. The calculation of the exact warning time shall be done for each crossing according to CPUC GO 75 and AREMA Signal Manual requirements. Advanced Pre-Emption shall be provided where required to clear traffic queues and provide sufficient time for adjacent controlled intersections to configure for crossing activation.

The design shall assume all trains stop at all stations for the purposes of setting Advanced Pre-Emption and Crossing Warning times. Where the start of a Crossing Warning extends to, or through, a station the contractor shall ensure, by means of cab signal code, that a train that fails to make a station stop cannot enter the crossing before the entrance gates are lowered. However, reductions in cab signal code to enforce minimum warning time shall not be implemented earlier than necessary. The goal shall be for such code reductions to be invisible to a train making a normal station stop.

Where a crossing is in advance of a station such that a minimum time cannot be given (after departure from the station), the crossing gates shall remain inactivated. If the operator does not stop, the gates shall be activated and the signal system shall impose a speed reduction or STOP code to ensure the train cannot enter the crossing before the entrance gates are lowered. The design shall provide a system for automatic gate activation prior to train departure. TWC shall be provided to cancel crossing activation and to reactivate the crossing.



The warning devices shall remain active until the crossing is cleared totally. These grade crossing systems shall be designed and installed in accordance with applicable Governmental Rules and, the recommendations of the AREMA and Manual of Uniform Traffic Control Devices (MUTCD).

All flashing light signals used in highway-rail crossing warning system installation shall be per requirements of CPUC GO-75D.

Where a 4-quadrant full-closure gate arrangement is required, the design shall arrange for the leading and trailing gates to operate as specified in CPUC GO 75. The design shall extend the approach time to take account of the delay in dropping all gates. All gates shall be individually monitored.

Crossing bell shall be an electronic type, conforming with AREMA Signal Manual, Part 3.2.61. The bell sound level shall be set to 77 dBa  $\pm$ 2 dBa at 10 feet in accordance with AREMA Signal Manual, Part 3.2.61, unless ambient noise levels dictate otherwise. Where an electronic processor is used for the crossing equipment, the design shall be such that the end user may elect, by means of external wiring alteration and without logic redesign, to silence the bells once all gates are horizontal. Such design shall prevent the bells from re-activating as the gates rise.

Provide an 8-inch lunar white LED Motorman's Signal for each track, located on the normal approach side of the crossing and facing trains approaching in the normal direction of traffic. Each Motorman's Signal shall display a solid aspect when the crossing approach is occupied and a flashing aspect when the gates are down and there is no detected malfunction of the crossing system.

Provide override raise and lower pushbuttons in a locked box.

#### **9.4.2.11 Track Switches**

All track switches shall be powered and interlocked. They shall normally be set and locked automatically. All route-setting functions shall apply. An over-switch (OS) track circuit shall be provided, occupation of which shall prevent powered movement of the switch.

A manual switch setting facility shall be provided at powered switch locations. The placing of a powered switch into manual operation shall result in loss of indication. Signals shall revert to their most restrictive aspect in the event of loss of indication of switch position.

Switch and lock mechanisms shall meet or exceed the recommendations of the AREMA Manual of Recommended Practices–Signals. The electrical, electromechanical or mechanical locking equipment shall prevent switch point movement when the switch points are in full normal or full reverse position. Three-phase operated switch machines shall be avoided unless exceptional site conditions (e.g. distance from control point) dictate use of same.

Parts of switch operating layouts shall be interchangeable between similar layouts.

#### **9.4.2.12 Traction Return Bonding**

The design shall provide impedance bonds and running rail continuity and cross bonding sufficient to comply with the traction return power requirements.

The design shall ensure that no single failure, including broken rail or loss of a bonding cable, shall result in loss of traction return capability through loss of continuity or failure due to overheating.

Traction power return capability shall be provided on all tracks regardless of whether OCS is present or not.

**9.4.2.13 Event Recorders**

AREMA recommended event recorders that store information for future playback shall be provided for vital systems, including grade crossings, to record changes in state of the vital systems and their devices, all alarms, status of all control and indication history.

Each recorder shall be standalone, capable of recording up to one week of events assuming a train movement in each direction at design headway 24 hours a day, 7 days a week. Each recording device shall provide access to the data through a standard USB interface port.

Event recorder time clock shall be synchronized with that of the solid state interlocking equipment. At any time, there shall be no more than a one second differential between the two time clocks.

**9.4.2.14 Environmental Requirements**

All equipment shall meet the environmental provisions of the AREMA ATCS environmental specifications and environmental requirements specified in these Design Criteria.

**9.4.2.15 Power Supply**

All housings shall be equipped with an external socket for the connection of a mobile generator. Signaling power supplies shall not be used for any purpose other than to power signaling equipment. In case of failure of the primary power source, backup power supply shall be provided to ensure safe train operation as follows:

Grade crossings	8 hours minimum
Vital equipment	4 hours minimum
Non-vital equipment	4 hours minimum
Switch machines	4 hours minimum at all interlockings

**9.4.2.16 Lightning Protection**

Lightning protection shall be provided for all equipment, which could be damaged by electrical transients.

**9.4.2.17 Design Integrity**

The system shall be designed and operated in a safe manner. Failure of the system shall not compromise the safety of train operation, road traffic or pedestrians.

Any circuit directly affecting the safety of train movement shall be considered “vital”. Circuits performing functions of control, indication, communication, and other tasks, which do not directly affect the safety of train movement, shall be considered “non-vital”.

All vital components shall be highly reliable, of proven design and have predictable failure modes, such that no single failure shall create a less restrictive state.

The signal system logic and its components shall be designed to meet the following:

- a) All vital components shall be designed so that restrictive (rather than permissive) actions occur when a component fails.
- b) All vital control logic shall be designed such that, if interrupted or de-energized, it shall cause the controlled function to assume its most restrictive condition.
- c) All relays or solid-state equivalents being energized by a vital circuit shall be vital units. All contacts used within any vital circuit shall be contacts of vital relays.
- d) All errors of hardware and software that may compromise vital data, whether stored within a logical process, sampled as digital or analog inputs, or produced as digital or analog output, shall result in a safe system state.

Non-vital circuits may use non-vital relay or solid-state technology. Failures of non-vital equipment shall not affect the safety of the system. Non-vital systems shall interface with vital systems in a manner, which isolates the vital systems from malfunctions of the non-vital systems.

Vital microprocessor systems shall be used.

The use of radio, land cable, or any combination, which forms a serial communication channel for the signal system, shall not be considered vital in itself. Design techniques shall be employed such that the equipment at each end of the communication link shall be capable of detecting errors in the data transmitted and received, such that system operation remains safe.

#### **9.4.2.18 Materials and Equipment**

##### **9.4.2.18.1 General**

Assemblies and components used to perform identical functions within the system shall be mechanically and electrically interchangeable. Standard commercially available equipment and material from multiple sources shall be used where practicable.

All wayside equipment shall be secured and protected by the use of tamper-resistant covers. Where deemed appropriate by the Designer, further protection shall be provided with intrusion detection devices.

All cables and wires shall be suitably protected. Conduits shall be provided under tracks, along bridges and through roadways, to meet AREMA recommendations. All material and equipment furnished shall be new and standard products of manufacturers regularly engaged in the production of like equipment.

##### **9.4.2.18.2 Equipment Location**

Signal equipment shall be located along the wayside only where necessary. All other

equipment shall be located on the outer edge of the right-of-way, in easily accessible equipment housings.

Signal houses and rooms shall be provided with a fire and intrusion detection system.

Signal masts, grade crossing gates, flasher masts, cantilever signal masts and all concrete signal structures shall follow CPUC GO 75 and City requirements for these structures.

#### **9.4.2.18.3 Equipment Housings**

All signal equipment housings shall include all required environmental controls to facilitate maintenance and operation, including any necessary heating, ventilation and air conditioning. As a minimum, air conditioning and forced air ventilation shall be provided at every enclosure. Heat load calculations shall support any heating, ventilation and air conditioning (HVAC) installation. Designed inside (indoor) temperature shall be less than a maximum operating temperature of any equipment to be installed in the case.

The signal equipment shall be capable of operation in the event of a failure of any environmental control subsystems. Houses, cases and junction boxes shall be steel or aluminum. Signal houses and cases containing electronic equipment shall be coated with reflective paint.

Wayside signal cases and bungalows shall not be placed between tracks without prior-approval. Wayside signal cases and bungalows shall be placed within the fenced right-of-way, with access to the right-of-way within 30 feet.

Minimum electrical service shall be 100 Amps. A change-over switch and 100 Amp generator plug-in point shall be provided. Plug-in point shall be accessible without having cables laid across or under the track.

All equipment-housing openings shall be screened or sealed to prevent entry of animals and insects to the extent practicable. All entryways shall be sealed following installation of cables and wiring entering the housing.

All insulation material used to line the interior of equipment housing walls, doors and roofs shall be flame retarding and non-electrically conductive, and shall not introduce a hazard of any type.

Doors of housings shall be capable of being secured by a standard padlock and equipped with a weatherproof seal.

All equipment housings shall be designed to accommodate possible future expansion of equipment space by 30%.

#### **9.4.2.18.4 Security of Equipment**

All signal equipment housings, cases, junction boxes, switch mechanisms, and signals shall be secured with an appropriate security device.

Provide card key access control in all rooms, bungalows and cases housing train control equipment.

#### 9.4.2.18.5 Train Control Logic Security

Whenever microprocessor logic is used, both for vital and non-vital train control purposes, implement security procedures to prevent unauthorized access to, modifications to, and operation of such.

#### 9.4.2.18.6 Maintainability

The signaling equipment shall be designed and constructed to facilitate quick and easy troubleshooting and module replacement. The design shall require a minimum of testing following module replacement.

Built-in indicators or meters shall be provided for routine maintenance, testing, and diagnostic purposes. The use of plug-in devices, such as laptop computers for the downloading of data from devices, including microprocessor interlockings, shall be allowed in addition to a basic set of fault indicators. As a minimum, LED indicators shall be provided for circuit boards to indicate the health status of a circuit board. A failed indication shall signify to a maintainer that the board should be replaced.

#### 9.4.2.19 SCADA Interface

The design shall provide remote control and monitoring of train control via the SCADA system. The design shall provide at least the following remote controls:

- Request, fleeting and canceling of routes for all wayside signals
- Request track and switch blocking
- Establish, change or cancel automatic terminal modes
- Move all switch machines
- Acknowledgement of alarms

The design shall provide at least the following indications and alarms:

- Occupancy of all track circuits, including overlays
- Wayside signal aspects
- Crossing gate status (all gates down)
- Switch position
- Switch locked
- Traffic direction
- Signal time lock
- Overrun indication
- Power off alarm (AC and DC)
- All other warning indications necessary to alert personnel of possible problems or failures (such as UPS, battery/charger alarms).
- Intrusion and fire alarms and equipment trouble.

### 9.4.3 Metro Blue Line Expansion

#### 9.4.3.1 General Requirements

The signaling system shall provide the following functions:

- Interlocking control of switches and signals
- Safe routing of trains
- Safe separation of trains to prevent collisions and side swipes by physically separated operation on the main line, protected by vital systems
- Protection of highway crossings against road/rail collisions giving railroad traffic priority by provision of highway crossing warning and protection systems and interfaces with highway traffic control equipment

The signaling system and grade crossings shall comply with the AREMA Manual of Recommended Practices - Signals and CPUC General Orders 75, and 143.

Automatic route setting shall be for normal train operation. Manual selection of routes shall be provided for abnormal train operation or when automatic routing is not desirable.

Bi-directional operation at full line speed and headway shall be provided throughout the main line. All sections under signal control shall be signaled such that, in the event either of the tracks in the double track sections is taken out of service, safe operations can be maintained.

The signal system shall provide continuous overspeed protection and speed commands (cab signal) operation, which shall prevent unsafe operation with respect to other trains, interlocking conditions, civil speed limits, and grade crossings.

Any transition from street running to cab signal territory shall be governed by a wayside signal. Overrun of such signal displaying STOP aspect shall trigger automatic brake application.

The cab signal system shall impose speed restrictions due to civil/track speed limits. In the normal direction of traffic the following design requirements shall be followed:

- The speed code reduction shall occur at a point no further than 110% of the Civil Braking Distance from the point of restriction.
- The cab signal and block design shall enable acceleration to the authorized speed (within safe braking constraints) to commence within 400 feet of the end of the speed restriction area.
- The maximum block length shall be 5,000 feet.
- All track circuits with a Maximum Authorized speed (MAS) exceeding 35 mph shall have at least one intermediate speed code before "STOP".
- All track circuits shall have a provision to allow for a manual downgrade to a more restrictive speed code via local control panel or hardware cards. Manual speed code selection shall not override safe train separation function of ATP.
- Exceptions to the above criteria shall be reviewed on a case-by-case basis.

The cab signal system shall impose speed restrictions on the approach to stations with an at-grade crossing on the exit side of the station. In the normal direction of traffic the following design requirements shall be followed:

- Speed code reduction, or removal of cab code shall occur on the approach to, or the exit from, the station to ensure that a train that fails to make a station stop, or does

not make a full 20-second dwell, cannot enter the crossing unless the entrance gates are fully down.

- Speed code reduction, or removal of cab code shall, never-the-less, maximize the train speed into the station.
- Speed code reductions shall be calculated using the Civil Braking Distance formula.
- Speed code reductions shall occur at a point no further than 120% of the Civil Braking Distance from the near side of the crossing.
- Crossings shall be activated automatically, assuming a 20-second station dwell. Once the entrance gates are down, full speed cab code shall be available.
- Where the crossing is within 100 feet of the station, a TWC system shall be provided to enable crossing calls to be called or cancelled.

**9.4.3.2 Safe Braking Distance Model**

**9.4.3.2.1 Introduction**

The Safe Braking Distance (SBD) is the calculated distance that a worst-case train will travel between the time that a speed reduction is commanded until the required speed reduction is achieved. The train operator is in control of the speed with the cab signal system providing over-speed protection only. The design shall utilize the SBD formula for all safety braking requirements.

The Civil Braking Distance (CBD) is the calculated distance that a train will travel between the time that a civil speed reduction is commanded until the required speed reduction is achieved. The train operator is in control of the speed with the cab signal system providing over-speed protection only. The CBD formula shall not be applied to safe train separation.

**Initial Entry Speed**

For SBD and CBD calculations, an initial entry speed (S) is used, which is derived from a combination of Cab Signal Speed (CSS), Cab Signal Tolerance (CST), Cab Signal Overspeed Allowance (CSO), and the Acceleration Allowance (AA) as follows:

CSS = 55, 45, 35, 25, 15, 10, or 0 mph according to the cab signal code immediately prior to entry.

CST = Tolerance in speed detection, which shall be as follows:

CSS	55	45	35	25	15	10	0
CST	+0, -1.5	+0, -1.5	+0, -1	+0, -1	+0, -1	+0, -1	+1, -1



CSO = Allowable exceedance of cab signal speed as detected by the carborne cab signal system, which shall be as follows:

CSS	55	45	35	25	15	10	0
CSO	2	2	3	3	3	3	2.5

AA = An allowance to account for instantaneous acceleration of the vehicle for the time delay between the decoding of the speed code by the carborne equipment, and removal of propulsion power. The allowance shall also include for jerk-limited removal of power and application of braking.

For SBD calculations,  $S = CSS + CST + CSO + AA$

For CBD calculations,  $S = CSS + CST + CSO$

**9.4.3.2.3 Safe Braking Distance Calculation**

$SBD = D_r + D_b + D_o$ , where:

$D_r = \text{Reaction distance in feet} = S \times R \times 1.467$

$D_b = \text{Braking Distance in feet} = 0.733 \times S^2 / (B \pm 0.2G)$

$D_o = \text{Overhang distance of two vehicles} = 30 \text{ feet}$

$S = \text{Initial entry speed (mph) prior to braking.}$

$R = \text{Reaction time in seconds (includes operator, cab signal delays and brake build-up)} = 9.8 \text{ seconds for a change in speed code and } 7.2 \text{ seconds for code-to-no code.}$

$B = \text{Safe Braking rate} = 2.0 \text{ mphps}$

$G = \text{Alignment grade as a decimal fraction}$

For safe braking calculations to bumping posts, the overhang distance of one vehicle (15 feet) can be used for distance  $D_o$ .

**9.4.3.2.4 Civil Braking Distance Calculation**

$CBD = D_r + D_b$ , where:

$D_r = \text{Reaction distance in feet} = (CSS) \times R \times 1.467$

$D_b = \text{Braking Distance in feet} = 0.733 \times (CSS^2 - V^2) / (B \pm 0.2G)$

$CSS = \text{Cab Signal Speed (mph) prior to braking.}$

$V = \text{Target speed at speed restriction}$



R = Reaction time in seconds (includes operator, cab signal delays and brake build-up) = 4.0 seconds.

B = Safe Braking rate = 2.0 mphps

G = Alignment grade as a decimal fraction

The target point for achieving the speed reduction shall be the tangent-to-spiral point on curves and the point of switch for turnouts.

Civil speed restrictions shall be maintained until the rear of the train is clear of the restriction. For curves, this shall be the curve-to-spiral point.

**9.4.3.3 Cab Signal System**

**9.4.3.3.1 Functionality Overview**

The cab signal received on-board the car shall be interpreted as a speed limit, the aspect of which, shall be displayed to the operator.

Code rates and their meanings shall be:

The nominal cab signal rail current

CODE RATE	INDICATION
410 PPM (6.83 Hz)	Cab signal cutout. Used for Street Running mode (35 mph speed limit).
270 PPM (4.5 Hz)	Proceed at 55 mph.
180 PPM (3 Hz)	Proceed at 45 mph.
120 PPM (2 Hz)	Proceed at 35 mph.
75 PPM (1.25 Hz)	Proceed at 25 mph.
50 PPM (0.833 Hz) @ 100Hz, asynchronously combined with 50 PPM (0.833 Hz) @ 250Hz	Proceed at 15 mph.
50 PPM (0.833 Hz)	Restricted (Yard). Proceed at maximum of 10 mph, prepared to stop.
Unmodulated 100 Hz	Stop
No Code	Stop and Proceed. Approaching a signal at stop or when occupancy exists ahead that requires immediate brake application to safely avoid a collision.

shall be 3 amps at the entering end of track circuits and the feed end shall be no greater than 20 amps.

The carrier frequency shall be 100 Hz ±2 Hz.

The code rate tolerance shall be ±5%.

The code duty cycle shall be 60/40 to 40/60.

Dead sections, such as at insulated rail joints, shall be no greater than 14 feet in length.

#### 9.4.3.4 Train-to-Wayside Communication

The Train-to-Wayside Communication (TWC) system shall be compatible with Hanning & Kahl HCS-V.

TWC transponders shall be provided at the following minimum locations:

- Approach to all wayside signals
- At stations with near-side at-grade crossings
- At the terminus station (for calling of a route onto the main line)

#### 9.4.3.5 Train Detection

The signaling system shall detect all cars operating independently or in consist, and any other rail vehicle present, except hi-rail vehicles.

The presence of a rail vehicle in a section of the route shall be detected continuously by means of track circuits.

Detection of the occupation of the track circuit shall be fail-safe, such that a de-energized position is interpreted as an occupation of the track circuit.

In the event of a temporary loss of detection, the design shall ensure that indication of the presence of a rail vehicle in a section will be maintained while a rail vehicle is actually in the section.

If a rail vehicle is parted in an unscheduled manner, the signal system shall ensure that all parts of the rail vehicle are detected. The signal system shall ensure that safe separation is maintained between the parted vehicle and all other rail vehicles.

The minimum effective length of a track circuit shall be longer than the maximum inner wheelbase of all vehicles used on this track.

For track circuits used to control signals and locking functions, including grade crossing activation devices, the minimum shunt sensitivity shall be 0.25 Ohms. The shunting requirements shall be met for ballast conditions of 5 ohms per thousand feet or greater.

#### 9.4.3.6 Broken Rail Detection

Broken rail detection shall be provided throughout. A broken rail shall de-energize the associated track circuit.

#### 9.4.3.7 Route Setting

There shall be three methods for control of train movement through the signalized sections as described below:

##### 9.4.3.7.1 Automatic Route Setting

Routes shall either normally operate automatically by signal and switch control subsystems responding to the approach of the train, or by use of a Fleet command (Metro shall

designate which shall be used for each interlocking).

In normal operation, routes shall clear automatically for consists without intervention by the train operator. At terminal stations the train operator shall be able, via TWC, to request that the departing signal be cleared for the train to proceed. Trains shall be normally routed reverse across before reaching the station as the preferred route, or the normal direction route if the preferred platform is occupied.

The ATC system shall use train ID, transmitted by the TWC system, in order to automatically route trains at junctions and turnback points for their designated route.

Fleet, if implemented, shall be provided for the normal traffic direction only.

**9.4.3.7.2 Selection of Routes from the Train**

Train-to-Wayside Communication route selection shall be provided at all interlocking signals.

**9.4.3.7.3 Local Route Selection Capability**

Local control capability shall be provided to ensure the safe operation of trains by means of Local Control Panels (LCP) in each signal house.

The LCP shall indicate track circuit occupancy, signal status, switch position and correspondence, switch locking, traffic direction, manual control, automatic control, and crossing gate position. Speed restriction enabled, AC alarm, DC alarm, communication failure alarm, system failure (Electrologixs, VHLC, iVPI, or Microlok) and all indications described in the specifications.

**9.4.3.8 Wayside Signals**

**9.4.3.8.1 Main line**

LED wayside color signals shall be provided to indicate movement authority, block occupation and route locking information to train operators. Signals shall be installed to govern movements into and through interlocking limits.

Wayside color signals shall show the following aspects, which are in compliance with Metro rules:

<u>Aspect</u>	<u>Meaning</u>
Red/Red	Stop
Flashing Green/Red	Block clear. Proceed on normal route. Trains operating with ATP Bypass activated shall be prepared to STOP at the next interlocking Signal.
Green/Red	Block occupied. Proceed on normal route with Cab Signals. Trains without cab signals or operating with ATP Bypass activated shall STOP and contact ROC.
Red/Flashing Green	Block clear. Proceed on diverging route. Trains operating with ATP Bypass activated shall be prepared to STOP at the next interlocking Signal.

<u>Aspect</u>	<u>Meaning</u>
Red/Green	Block occupied. Proceed on diverging route with Cab Signals. Trains without Cab Signals or operating with ATP Bypass activated shall STOP and contact ROC.
Flashing Red/Red	STOP and contact ROC. Proceed indication cannot be displayed. When authorized by ROC, proceed in Stop and Proceed mode on Normal Route.
Red/Flashing Red	STOP and contact ROC. Proceed indication cannot be displayed. When authorized by ROC, proceed in Stop and Proceed mode on diverging route.

Indication on signals or switches shall be fail-safe, such that no less restrictive aspect is shown than intended. "Block Clear" aspects shall not be used in street-running areas.

Wayside signals shall be located such that they are sufficiently visible to preclude confusion with signals governing the operation of motor vehicles, and similarly do not confuse motor vehicle drivers. When viewed from a height of 7 feet above top of rail, at a distance of 500 ft, lenses shall present a distinct aspect under the most adverse operating conditions.

Provide a signal number plate for each signal. The signal number plate shall be placed under the lowest signal lens in the assembly. Signal plates shall meet the requirements of the AREMA Manual of Recommended Practices – Signals. The alphanumeric characters shall be a minimum of 3 inches high.

The top of the top-most aspect shall be set at 5'-5 3/8" above Top of Rail or as approved by Metro.

9.4.3.8.2 Tunnel Hold

Provide two-aspect LED wayside signals mounted in the immediate vicinity of a tunnel portal, oriented towards tunnel-bound trains. Signals shall have the following aspects:

<u>Aspect</u>	<u>Meaning</u>
Green	Ventilation zone clear.
Red	Ventilation zone occupied.

Ventilation zone occupancy detection and indication circuits shall be fail safe.

Other requirements for these signals, including sighting distance, construction and circuit requirements shall be as described in 9.4.3.8.1.

#### **9.4.3.9 Interlockings**

As a minimum, the following locking functions shall be provided for powered switch interlockings:

- a) Switch locking - A locking function shall ensure that a signal governing a switch or combination of switches shall only show a less restrictive aspect than "stop", when all switches are in the correct position.
- b) Automatic Block locking - A home signal governing a block shall only show a less restrictive aspect than "stop", when the entire block is unoccupied by any trains or vehicles. This shall be controlled automatically by means of track circuits throughout the entire block.
- c) Route locking - Route locking shall lock switches within a route after a signal has been requested for train movement onto that route, and shall prevent clearing of opposing and conflicting signals within the interlocking. Route locking shall be in effect when approach locking is in effect, and it shall remain in effect until the rear of the train has cleared the route.

Switches, which are part of the route, and switches or signals, which are protecting against flanking (side-swipe), shall be disabled from moving when the route is locked. Signals protecting this route shall be prevented from showing aspects other than stop.

- d) Approach locking - Approach locking shall lock switches within a route governed by a cleared wayside signal to prevent clearing wayside signals for opposing or conflicting routes.
- e) Time locking - Time locking shall ensure that all switches and signals forming a route, and those protecting it, remain in position and locked for a predetermined time after the entry signal has been caused to display its most restrictive aspect again.
- f) Traffic locking - Setting and locking of a route shall be prohibited unless the opposing signals show the most restrictive aspect. The signal system shall furthermore prevent any trains simultaneously entering the same block section from different directions or tracks.

Independent of any route locking function, the movement of any powered switch shall be

prevented when track occupancy is detected in the track section in which that switch is located.

The switch locking function shall have 5 seconds loss of shunt protection. However, sectional release shall be provided where practicable, to support headways through junctions.

Any failure, including loss of power, to any part of an interlocking shall not result in the premature release of any locking function.

Overrun detection shall be provided for every interlocking signal.

#### **9.4.3.10 Public Highway Crossings**

##### **9.4.3.10.1 General**

Activation of grade crossing warning devices shall be normally achieved by all rail vehicles using the main line, but excluding hi-rail vehicles.

##### **9.4.3.10.2 Highway Crossing Warning Activation**

Warning devices shall normally be automatically activated by the approach of a rail vehicle with a nominally uniform warning time. The devices shall be direction sensitive, and shall be activated by the approach of a train on any track from either direction.

The Crossing Warning time shall be able to be adjusted between a maximum of 30 seconds (or greater if city requirements demand such) and a minimum of 20 seconds. The calculation of the exact warning time shall be done for each crossing according to CPUC GO 75 and AREMA Signal Manual requirements. Advanced Pre-Emption shall be provided where required to clear traffic queues and provide sufficient time for adjacent controlled intersections to configure for crossing activation.

The design shall assume all trains stop at all stations for the purposes of setting Advanced Pre-Emption and Crossing Warning times. Where the start of a Crossing Warning extends to, or through, a station the contractor shall ensure, by means of cab signal code, that a train that fails to make a station stop cannot enter the crossing before the entrance gates are lowered. However, reductions in cab signal code to enforce minimum warning time shall not be implemented earlier than necessary. The goal shall be for such code reductions to be invisible to a train making a normal station stop.

Where a crossing is in advance of a station such that a minimum time cannot be given (after departure from the station), the crossing gates shall remain inactivated. If the operator does not stop, the gates shall be activated and the signal system shall impose a speed reduction or STOP code to ensure the train cannot enter the crossing before the entrance gates are lowered. The design shall provide a system for automatic gate activation prior to train departure. TWC shall be provided to cancel crossing activation and to reactivate the crossing.

The warning devices shall remain active until the crossing is cleared totally. These grade crossing systems shall be designed and installed in accordance with applicable Governmental Rules and, the recommendations of the AREMA and Manual of Uniform Traffic Control Devices (MUTCD).

All flashing light signals used in highway-rail crossing warning system installation shall be per requirements of CPUC GO-75D.

Where a 4-quadrant full-closure gate arrangement is required, the design shall arrange for the leading and trailing gates to operate as specified in CPUC GO 75. The design shall extend the approach time to take account of the delay in dropping all gates. All gates shall be individually monitored.

Crossing bell shall be an electronic type, conforming with AREMA Signal Manual, Part 3.2.61. The bell sound level shall be set to 77 dBa  $\pm$ 2 dBa at 10 feet in accordance with AREMA Signal Manual, Part 3.2.61, unless ambient noise levels dictate otherwise. Where an electronic processor is used for the crossing equipment, the design shall be such that the end user may elect, by means of external wiring alteration and without logic redesign, to silence the bells once all gates are horizontal. Such design shall prevent the bells from re-activating as the gates rise.

Provide an 8-inch lunar white LED Motorman's Signal for each track, located on the normal approach side of the crossing and facing trains approaching in the normal direction of traffic. Each Motorman's Signal shall display a solid aspect when the crossing approach is occupied and a flashing aspect when the gates are down and there is no detected malfunction of the crossing system.

#### **9.4.3.11 Track Switches**

All track switches shall be powered and interlocked. They shall normally be set and locked automatically. All route-setting functions shall apply. An over-switch (OS) track circuit shall be provided, occupation of which shall prevent powered movement of the switch.

A manual switch setting facility shall be provided at powered switch locations. The placing of a powered switch into manual operation shall result in loss of indication. Signals shall revert to their most restrictive aspect in the event of loss of indication of switch position.

Switch and lock mechanisms shall meet or exceed the recommendations of the AREMA Manual of Recommended Practices–Signals. The electrical, electromechanical or mechanical locking equipment shall prevent switch point movement when the switch points are in full normal or full reverse position. Three-phase operated switch machines shall be avoided unless exceptional site conditions (e.g. distance from control point) dictate use of same.

Parts of switch operating layouts shall be interchangeable between similar layouts.

#### **9.4.3.12 Traction Return Bonding**

The design shall provide impedance bonds and running rail continuity and cross bonding sufficient to comply with the traction return power requirements.

The design shall ensure that no single failure, including broken rail or loss of a bonding cable, shall result in loss of traction return capability through loss of continuity or failure due to overheating.

Traction power return capability shall be provided on all tracks regardless of whether OCS is

present or not.

**9.4.3.13 Event Recorders**

AREMA recommended event recorders that store information for future playback shall be provided for vital systems, including grade crossings, to record changes in state of the vital systems and their devices, all alarms, status of all control and indication history.

Each recorder shall be standalone, capable of recording up to one week of events assuming a train movement in each direction at design headway 24 hours a day, 7 days a week. Each recording device shall provide access to the data through a standard USB interface port.

Event recorder time clock shall be synchronized with that of the solid state interlocking equipment. At any time, there shall be no more than a one second differential between the two time clocks.

**9.4.3.14 Environmental Requirements**

All equipment shall meet the environmental provisions of the AREMA ATCS environmental specifications and environmental requirements specified in these Design Criteria.

**9.4.3.15 Power Supply**

All housings shall be equipped with an external socket for the connection of a mobile generator. Signaling power supplies shall not be used for any purpose other than to power signaling equipment. In case of failure of the primary power source, backup power supply shall be provided to ensure safe train operation as follows:

Grade crossings	8 hours minimum
Vital equipment	4 hours minimum
Non-vital equipment	4 hours minimum
Switch machines	4 hours minimum at all interlockings

**9.4.3.16 Lightning Protection**

Lightning protection shall be provided for all equipment, which could be damaged by electrical transients.

**9.4.3.17 Design Integrity**

The system shall be designed and operated in a safe manner. Failure of the system shall not compromise the safety of train operation, road traffic or pedestrians.

Any circuit directly affecting the safety of train movement shall be considered “vital”. Circuits performing functions of control, indication, communication, and other tasks, which do not directly affect the safety of train movement, shall be considered “non-vital”.

All vital components shall be highly reliable, of proven design and have predictable failure modes, such that no single failure shall create a less restrictive state.



The signal system logic and its components shall be designed to meet the following:

- a) All vital components shall be designed so that restrictive (rather than permissive) actions occur when a component fails.
- b) All vital control logic shall be designed such that, if interrupted or de-energized, it shall cause the controlled function to assume its most restrictive condition.
- c) All relays or solid-state equivalents being energized by a vital circuit shall be vital units. All contacts used within any vital circuit shall be contacts of vital relays.
- d) All errors of hardware and software that may compromise vital data, whether stored within a logical process, sampled as digital or analog inputs, or produced as digital or analog output, shall result in a safe system state.

Non-vital circuits may use non-vital relay or solid-state technology. Failures of non-vital equipment shall not affect the safety of the system. Non-vital systems shall interface with vital systems in a manner, which isolates the vital systems from malfunctions of the non-vital systems.

Vital microprocessor systems shall be used.

The use of radio, land cable, or any combination, which forms a serial communication channel for the signal system, shall not be considered vital in itself. Design techniques shall be employed such that the equipment at each end of the communication link shall be capable of detecting errors in the data transmitted and received, such that system operation remains safe.

### **9.4.3.18 Materials and Equipment**

#### **9.4.3.18.1 General**

Assemblies and components used to perform identical functions within the system shall be mechanically and electrically interchangeable. Standard commercially available equipment and material from multiple sources shall be used where practicable.

All wayside equipment shall be secured and protected by the use of tamper-resistant covers. Where deemed appropriate by the Designer, further protection shall be provided with intrusion detection devices.

All cables and wires shall be suitably protected. Conduits shall be provided under tracks, along bridges and through roadways, to meet AREMA recommendations. All material and equipment furnished shall be new and standard products of manufacturers regularly engaged in the production of like equipment.

#### **9.4.3.18.2 Equipment Location**

Signal equipment shall be located along the wayside only where necessary. All other equipment shall be located on the outer edge of the right-of-way, in easily accessible equipment housings.

Signal houses and rooms shall be provided with a fire and intrusion detection system.

Signal masts, grade crossing gates, flasher masts, cantilever signal masts and all concrete signal structures shall follow CPUC GO 75 and City requirements for these structures.

#### **9.4.3.18.3 Equipment Housings**

All signal equipment housings shall include all required environmental controls to facilitate maintenance and operation, including any necessary heating, ventilation and air conditioning.

As a minimum, air conditioning and forced air ventilation shall be provided at every enclosure. Heat load calculations shall support any heating, ventilation and air conditioning (HVAC) installation. Designed inside (indoor) temperature shall be less than a maximum operating temperature of any equipment to be installed in the case.

The signal equipment shall be capable of operation in the event of a failure of any environmental control subsystems. Houses, cases and junction boxes shall be steel or aluminum. Signal houses and cases containing electronic equipment shall be coated with reflective paint.

Wayside signal cases and bungalows shall not be placed between tracks without prior-approval. Wayside signal cases and bungalows shall be placed within the fenced right-of-way, with access to the right-of-way within 30 feet.

Minimum electrical service shall be 100 Amps. A change-over switch and 100 Amp generator plug-in point shall be provided. Plug-in point shall be accessible without having cables laid across or under the track.

All equipment-housing openings shall be screened or sealed to prevent entry of animals and insects to the extent practicable. All entryways shall be sealed following installation of cables and wiring entering the housing.

All insulation material used to line the interior of equipment housing walls, doors and roofs shall be flame retarding and non-electrically conductive, and shall not introduce a hazard of any type.

Doors of housings shall be capable of being secured by a standard padlock and equipped with a weatherproof seal.

All equipment housings shall be designed to accommodate possible future expansion of equipment space by 30%.

#### **9.4.3.18.4 Security of Equipment**

All signal equipment housings, cases, junction boxes, switch mechanisms, and signals shall be secured with an appropriate security device.

Provide intrusion detection in all rooms, bungalows and cases housing train control equipment.

#### **9.4.3.18.5 Train Control Logic Security**

Whenever microprocessor logic is used, both for vital and non-vital train control purposes, implement security procedures to prevent unauthorized access to, modifications to, and operation of such.

#### **9.4.3.18.6 Maintainability**

The signaling equipment shall be designed and constructed to facilitate quick and easy troubleshooting and module replacement. The design shall require a minimum of testing following module replacement.

Built-in indicators or meters shall be provided for routine maintenance, testing, and diagnostic purposes. The use of plug-in devices, such as laptop computers for the downloading of data from devices, including microprocessor interlockings, shall be allowed in addition to a basic set of fault indicators. As a minimum, LED indicators shall be provided for circuit boards to indicate the health status of a circuit board. A failed indication shall signify to a maintainer that the board should be replaced.

#### **9.4.3.19 SCADA Interface**

The design shall provide remote control and monitoring of train control via the SCADA system. The design shall provide at least the following remote controls:

- Request, fleeting or canceling routes for all wayside signals
- Request track and switch blocking
- Establish, change or cancel automatic terminal modes
- Move all switch machines
- Acknowledgement of alarms

The design shall provide at least the following indications and alarms:

- Occupancy of all track circuits, including overlays
- Wayside signal aspects
- Crossing gate status (all gates down)
- Switch position
- Switch locked
- Traffic direction
- Signal time lock
- Overrun indication
- All other warning indications necessary to alert personnel of possible problems or failures (such as battery/charger alarms, power off alarm).
- Intrusion and fire alarms and equipment trouble.

### **9.4.4 Metro Green Line Expansion**

#### **9.4.4.1 General Requirements**

The signaling system shall provide the following functions:

- Interlocking control of switches and signals
- Safe routing of trains

- Safe separation of trains to prevent collisions and side swipes by physically separated operation on the main line, protected by vital systems
- Protection of highway crossings against road/rail collisions giving railroad traffic priority by provision of highway crossing warning and protection systems and interfaces with highway traffic control equipment
- Automatic Train Operation (ATO) in fully-exclusive Right-of-Way

The signaling system and grade crossings shall comply with the AREMA Manual of Recommended Practices - Signals and CPUC General Orders 75, and 143.

Automatic route setting shall be for normal train operation. Manual selection of routes shall be provided for abnormal train operation or when automatic routing is not desirable.

Bi-directional operation at full line speed and headway shall be provided throughout the main line. All sections under signal control shall be signaled such that, in the event either of the tracks in the double track sections is taken out of service, safe operations can be maintained.

The signal system shall provide continuous overspeed protection and speed commands (cab signal) operation, which shall prevent unsafe operation with respect to other trains, interlocking conditions, civil speed limits, and grade crossings.

Any transition from street running to cab signal territory shall be governed by a wayside signal. Overrun of such signal displaying STOP aspect shall trigger automatic brake application.

The cab signal system shall impose speed restrictions due to civil/track speed limits. In the normal direction of traffic the following design requirements shall be followed:

- The speed code reduction shall occur at a point no further than 110% of the Civil Braking Distance from the point of restriction.
- The cab signal and block design shall enable acceleration to the authorized speed (within safe braking constraints) to commence within 400 feet of the end of the speed restriction area.
- The maximum block length shall be 2,000 feet.
- All track circuits with a Maximum Authorized speed (MAS) exceeding 35 mph shall have at least one intermediate speed code before "STOP".
- All track circuits shall have a provision to allow for a manual downgrade to a more restrictive speed code via local control panel or hardware cards. Manual speed code selection shall not override safe train separation function of ATP.
- Exceptions to the above criteria shall be reviewed on a case-by-case basis.

The cab signal system shall impose speed restrictions on the approach to stations with an at-grade crossing on the exit side of the station. In the normal direction of traffic the following design requirements shall be followed:

- Speed code reduction, or removal of cab code shall occur on the approach to, or the exit from, the station to ensure that a train that fails to make a station stop, or does not make a full 20-second dwell, cannot enter the crossing unless the entrance gates are fully down.

- Speed code reduction, or removal of cab code shall, never-the-less, maximize the train speed into the station.
- Speed code reductions shall be calculated using the Civil Braking Distance formula.
- Speed code reductions shall occur at a point no further than 120% of the Civil Braking Distance from the near side of the crossing.
- Crossings shall be activated automatically, assuming a 20-second station dwell. Once the entrance gates are down, full speed cab code shall be available.
- Where the crossing is within 100 feet of the station, a TWC system shall be provided to enable crossing calls to be called or cancelled.

#### **9.4.4.2 Train-to-Wayside Communication**

The Train-to-Wayside Communications (TWC) System shall be fully compatible with existing TWC system used on Metro Green Line. TWC loops shall be provided at the following minimum locations:

- All station tracks
- All pocket and siding tracks.
- All mainline track segments used for turnback moves.
- In transfer zones of yard leads.

#### **9.4.4.3 Train Detection**

The signaling system shall detect all cars operating independently or in consist, and any other rail vehicle present, except hi-rail vehicles.

The presence of a rail vehicle in a section of the route shall be detected continuously by means of track circuits.

Detection of the occupation of the track circuit shall be fail-safe, such that a de-energized position is interpreted as an occupation of the track circuit.

In the event of a temporary loss of detection, the design shall ensure that indication of the presence of a rail vehicle in a section will be maintained while a rail vehicle is actually in the section.

If a rail vehicle is parted in an unscheduled manner, the signal system shall ensure that all parts of the rail vehicle are detected. The signal system shall ensure that safe separation is maintained between the parted vehicle and all other rail vehicles.

The minimum effective length of a track circuit shall be longer than the maximum inner wheelbase of all vehicles used on this track.

For track circuits used to control signals and locking functions, including grade crossing activation devices, the minimum shunt sensitivity shall be 0.25 Ohms. The shunting requirements shall be met for ballast conditions of 5 ohms per thousand feet or greater.

#### **9.4.4.4 Broken Rail Detection**

Broken rail detection shall be provided throughout. A broken rail shall de-energize the associated track circuit.

**9.4.4.5 Route Setting**

There shall be three methods for control of train movement through the signalized sections as described below.

**9.4.4.5.1 Automatic Route Setting**

Routes shall normally operate automatically by signal and switch control subsystems responding to the approach of the train.

In normal operation, routes shall clear automatically for consists without intervention by the train operator. At terminal stations the train operator shall be able, via TWC, to request that the departing signal be cleared for the train to proceed. Trains shall be normally routed reverse across before reaching the station as the preferred route, or the normal direction route if the preferred platform is occupied.

**9.4.4.5.2 Selection of Routes from the Train**

Train-to-Wayside Communication route selection shall be provided at all interlockings, and at the terminal station.

**9.4.4.5.3 Local Route Selection Capability**

Local control capability shall be provided to ensure the safe operation of trains by means of Local Control Panels (LCP) in each signal house.

The LCP shall indicate track circuit occupancy, signal status, switch position and correspondence, switch locking, traffic direction, manual control, automatic control, and crossing gate position, speed restriction enable and reset, AC alarm, DC alarm, communication failure alarm and system failure (Electrologixs, VHLC, iVPI, or Microlok).

**9.4.4.6 Wayside Signals**

**9.4.4.6.1 Main line**

Wayside color signals shall be provided to indicate movement authority, block occupation and route locking information to train operators. Signals shall be installed to govern movements into and through interlocking limits.

Wayside color signals shall show the following aspects, which are in compliance with Metro rules:

<u>Aspect</u>	<u>Meaning</u>
Red	Stop
Flashing Red	STOP and contact ROC. Proceed when authorized by ROC.
Flashing Yellow	Proceed on diverging route into reverse traffic.
Yellow	Proceed on diverging route into normal traffic.
Flashing Green	Proceed on normal route into reverse traffic.
Green	Proceed on normal route into normal traffic.

Indication on signals or switches shall be fail-safe, such that no less restrictive aspect is shown than intended.

Wayside signals shall be located such that they are sufficiently visible to preclude confusion with signals governing the operation of motor vehicles, and similarly do not confuse motor vehicle drivers. When viewed from a height of 7 feet above top of rail, at a distance of 500 ft, lenses shall present a distinct aspect under the most adverse operating conditions.

Provide a signal number plate for each signal. The signal number plate shall be placed under the lowest signal lens in the assembly. Signal plates shall meet the requirements of the AREMA Manual of Recommended Practices – Signals. The alphanumeric characters shall be a minimum of 3 inches high.

#### 9.4.4.6.2 Tunnel Hold

<u>Aspect</u>	<u>Meaning</u>
Green	Ventilation zone clear.
Red	Ventilation zone occupied.

Ventilation zone occupancy detection and indication circuits shall be fail safe.

Other requirements for these signals, including sighting distance, construction and circuit requirements shall be as described in 9.4.2.8.1.

#### 9.4.4.7 Interlockings

As a minimum, the following locking functions shall be provided for powered switch interlockings:

- a) Switch locking - A locking function shall ensure that a signal governing a switch or combination of switches shall only show a less restrictive aspect than "stop", when all switches are in the correct position.
- b) Automatic Block locking - A home signal governing a block shall only show a less restrictive aspect than "stop", when the entire block is unoccupied by any trains or vehicles. This shall be controlled automatically by means of track circuits throughout the entire block.
- c) Route locking - Route locking shall lock switches within a route after a signal has been requested for train movement onto that route, and shall prevent clearing of opposing and conflicting signals within the interlocking. Route locking shall be in effect when approach locking is in effect, and it shall remain in effect until the rear of the train has cleared the route.

Switches, which are part of the route, and switches or signals, which are protecting against flanking (side-swipe), shall be disabled from moving when the route is locked. Signals protecting this route shall be prevented from showing aspects other than stop.

- d) Approach locking - Approach locking shall lock switches within a route governed by a cleared wayside signal to prevent clearing wayside signals for opposing or conflicting routes.



- e) Time locking - Time locking shall ensure that all switches and signals forming a route, and those protecting it, remain in position and locked for a predetermined time after the entry signal has been caused to display its most restrictive aspect again.
- f) Traffic locking - Setting and locking of a route shall be prohibited unless the opposing signals show the most restrictive aspect. The signal system shall furthermore prevent any trains simultaneously entering the same block section from different directions or tracks.

Independent of any route locking function, the movement of any powered switch shall be prevented when track occupancy is detected in the track section in which that switch is located.

The switch locking function shall have 5 seconds loss of shunt protection. However, sectional release shall be provided where practicable, to support headways through junctions.

Any failure, including loss of power, to any part of an interlocking shall not result in the premature release of any locking function.

Overrun detection shall be provided for every interlocking signal.

#### **9.4.4.8 Public Highway Crossings**

##### **9.4.4.8.1 General**

Activation of grade crossing warning devices shall be normally achieved by all rail vehicles using the main line, but excluding hi-rail vehicles.

##### **9.4.4.8.2 Highway Crossing Warning Activation**

Warning devices shall normally be automatically activated by the approach of a rail vehicle with a nominally uniform warning time. The devices shall be direction sensitive, and shall be activated by the approach of a train on any track from either direction.

The Crossing Warning time shall be able to be adjusted between a maximum of 30 seconds (or greater if city requirements demand such) and a minimum of 20 seconds. The calculation of the exact warning time shall be done for each crossing according to CPUC GO 75 and AREMA Signal Manual requirements. Advanced Pre-Emption shall be provided where required to clear traffic queues and provide sufficient time for adjacent controlled intersections to configure for crossing activation.

The design shall assume all trains stop at all stations for the purposes of setting Advanced Pre-Emption and Crossing Warning times. Where the start of a Crossing Warning extends to, or through, a station the contractor shall ensure, by means of cab signal code, that a train that fails to make a station stop cannot enter the crossing before the entrance gates are lowered. However, reductions in cab signal code to enforce minimum warning time shall not be implemented earlier than necessary. The goal shall be for such code reductions to be invisible to a train making a normal station stop.



Where a crossing is in advance of a station such that a minimum time cannot be given (after departure from the station), the crossing gates shall remain inactivated. If the operator does not stop, the gates shall be activated and the signal system shall impose a speed reduction or STOP code to ensure the train cannot enter the crossing before the entrance gates are lowered. The design shall provide a system for gate activation prior to train departure. This system shall be by means of TWC.

The warning devices shall remain active until the crossing is cleared totally. These grade crossing systems shall be designed and installed in accordance with applicable Governmental Rules and, the recommendations of the AREMA and Manual of Uniform Traffic Control Devices (MUTCD).

All flashing light signals used in highway-rail crossing warning system installation shall be per requirements of CPUC GO-75D.

Where a 4-quadrant full-closure gate arrangement is required, the design shall arrange for the leading and trailing gates to operate as specified in CPUC GO 75. The design shall extend the approach time to take account of the delay in dropping all gates. All gates shall be individually monitored.

Crossing bell shall be an electronic type, conforming with AREMA Signal Manual, Part 3.2.61. The bell sound level shall be set to 77 dBa  $\pm$ 2 dBa at 10 feet in accordance with AREMA Signal Manual, Part 3.2.61, unless ambient noise levels dictate otherwise. Where an electronic processor is used for the crossing equipment, the design shall be such that the end user may elect, by means of external wiring alteration and without logic redesign, to silence the bells once all gates are horizontal. Such design shall prevent the bells from re-activating as the gates rise.

Provide an 8-inch lunar white LED Motorman's Signal for each track, located on the normal approach side of the crossing and facing trains approaching in the normal direction of traffic. Each Motorman's Signal shall display a solid aspect when the crossing approach is occupied and a flashing aspect when the gates are down and there is no detected malfunction of the crossing system.

#### **9.4.4.9 Track Switches**

All track switches shall be powered and interlocked. They shall normally be set and locked automatically. All route-setting functions shall apply. An over-switch (OS) track circuit shall be provided, occupation of which shall prevent powered movement of the switch.

A manual switch setting facility shall be provided at powered switch locations. The placing of a powered switch into manual operation shall result in loss of indication. Signals shall revert to their most restrictive aspect in the event of loss of indication of switch position.

Switch and lock mechanisms shall meet or exceed the recommendations of the AREMA Manual of Recommended Practices—Signals. The electrical, electromechanical or mechanical locking equipment shall prevent switch point movement when the switch points are in full normal or full reverse position. Three-phase operated switch machines shall be avoided unless exceptional site conditions (e.g. distance from control point) dictate use of same.

Parts of switch operating layouts shall be interchangeable between similar layouts.

**9.4.4.10 Traction Return Bonding**

The design shall provide impedance bonds and running rail continuity and cross bonding sufficient to comply with the traction return power requirements.

The design shall ensure that no single failure, including broken rail or loss of a bonding cable, shall result in loss of traction return capability through loss of continuity or failure due to overheating.

Traction power return capability shall be provided on all tracks regardless of whether OCS is present or not.

**9.4.4.11 Event Recorders**

AREMA recommended event recorders that store information for future playback shall be provided for vital systems, including grade crossings, to record changes in state of the vital systems and their devices, all alarms, status of all control and indication history.

Each recorder shall be standalone, capable of recording up to one week of events, assuming a train movement in each direction at design headway 24 hours a day, 7 days a week. Each recording device shall provide access to the data through a standard USB interface port.

Event recorder time clock shall be synchronized with that of the solid state interlocking equipment. At any time, there shall be no more than a one second differential between the two time clocks.

**9.4.4.12 Environmental Requirements**

All equipment shall meet the environmental provisions of the AREMA ATCS environmental specifications and environmental requirements specified in these Contract Documents.

**9.4.4.13 Power Supply**

All housings shall be equipped with an external socket for the connection of a mobile generator. Signaling power supplies shall not be used for any purpose other than to power signaling equipment. In case of failure of the primary power source, backup power supply shall be provided to ensure safe train operation as follows:

Grade crossings	8 hours minimum
Vital equipment	4 hours minimum
Non-vital equipment	4 hours minimum
Switch machines	4 hours minimum at all interlockings

**9.4.4.14 Lightning Protection**

Lightning protection shall be provided for all equipment, which could be damaged by electrical transients.

#### 9.4.4.15 Design Integrity

The system shall be designed and operated in a safe manner. Failure of the system shall not compromise the safety of train operation, road traffic or pedestrians.

Any circuit directly affecting the safety of train movement shall be considered “vital”. Circuits performing functions of control, indication, communication, and other tasks, which do not directly affect the safety of train movement, shall be considered “non-vital”.

All vital components shall be highly reliable, of proven design and have predictable failure modes, such that no single failure shall create a less restrictive state.

The signal system logic and its components shall be designed to meet the following:

- a) All vital components shall be designed so that restrictive (rather than permissive) actions occur when a component fails.
- b) All vital control logic shall be designed such that, if interrupted or de-energized, it shall cause the controlled function to assume its most restrictive condition.
- c) All relays or solid-state equivalents being energized by a vital circuit shall be vital units. All contacts used within any vital circuit shall be contacts of vital relays.
- d) All errors of hardware and software that may compromise vital data, whether stored within a logical process, sampled as digital or analog inputs, or produced as digital or analog output, shall result in a safe system state.

Non-vital circuits may use non-vital relay or solid-state technology. Failures of non-vital equipment shall not affect the safety of the system. Non-vital systems shall interface with vital systems in a manner, which isolates the vital systems from malfunctions of the non-vital systems.

Vital microprocessor systems may be used.

The use of radio, land cable, or any combination, which forms a serial communication channel for the signal system, shall not be considered vital in itself. Design techniques shall be employed such that the equipment at each end of the communication link shall be capable of detecting errors in the data transmitted and received, such that system operation remains safe.

#### 9.4.4.16 Materials and Equipment

##### 9.4.4.16.1 General

Assemblies and components used to perform identical functions within the system shall be mechanically and electrically interchangeable. Standard commercially available equipment and material from multiple sources shall be used where practicable.

All wayside equipment shall be secured and protected by the use of tamper-resistant covers. Where deemed appropriate by the Designer, further protection shall be provided with intrusion detection devices.

All cables and wires shall be suitably protected. Conduits shall be provided under tracks, along bridges and through roadways, to meet AREMA recommendations. All material and equipment furnished shall be new and standard products of manufacturers regularly engaged in the production of like equipment, and shall be the latest design, which complies with the requirements of these Contract Documents.

#### **9.4.4.16.2 Equipment Location**

Signal equipment shall be located along the wayside only where necessary. All other equipment shall be located on the outer edge of the right-of-way, in easily accessible equipment housings.

Signal houses and rooms shall be provided with a fire and intrusion detection system.

Signal masts, grade crossing gates, flasher masts, cantilever signal masts and all concrete signal structures shall follow CPUC GO 75 and City requirements for these structures.

#### **9.4.4.16.3 Equipment Housings**

All signal equipment housings shall include all required environmental controls to facilitate maintenance and operation, including any necessary heating, ventilation and air conditioning. As a minimum, air conditioning and forced air ventilation shall be provided at every enclosure. Heat load calculations shall support any heating, ventilation and air conditioning (HVAC) installation. Designed inside (indoor) temperature shall be less than a maximum operating temperature of any equipment to be installed in the case.

The signal equipment shall be capable of operation in the event of a failure of any environmental control subsystems. Houses, cases and junction boxes shall be steel or aluminum. Signal houses and cases containing electronic equipment shall be coated with reflective paint.

Wayside signal cases and bungalows shall not be placed between tracks without prior-approval. Wayside signal cases and bungalows shall be placed within the fenced right-of-way, with access to the right-of-way within 30 feet.

Minimum electrical service shall be 100 Amps. A change-over switch and 100 Amp generator plug-in point shall be provided. Plug-in point shall be accessible without having cables laid across or under the track.

All equipment-housing openings shall be screened or sealed to prevent entry of animals and insects to the extent practicable. All entryways shall be sealed following installation of cables and wiring entering the housing.

All insulation material used to line the interior of equipment housing walls, doors and roofs shall be flame retarding and non-electrically conductive, and shall not introduce a hazard of any type.

Doors of housings shall be capable of being secured by a standard padlock and equipped with a weatherproof seal.

All equipment housings shall be designed to accommodate possible future expansion of equipment space by 30%.

**9.4.4.16.4 Security of Equipment**

All signal equipment housings, cases, junction boxes, switch mechanisms, and signals shall be secured with an appropriate security device.

Provide intrusion detection in all rooms, bungalows and cases housing train control equipment.

**9.4.4.16.5 Train Control Logic Security**

**Whenever microprocessor logic is used, both for vital and non-vital train control purposes, implement security procedures to prevent unauthorized access to, modifications of, and operation of such.**

**9.4.4.16.6 Maintainability**

The signaling equipment shall be designed and constructed to facilitate quick and easy troubleshooting and module replacement. The design shall require a minimum of testing following module replacement.

Built-in indicators or meters shall be provided for routine maintenance, testing, and diagnostic purposes. The use of plug-in devices, such as laptop computers for the downloading of data from devices, including microprocessor interlockings, shall be allowed in addition to a basic set of fault indicators. As a minimum, LED indicators shall be provided for circuit boards to indicate the health status of a circuit board. A failed indication shall signify to a maintainer that the board should be replaced.

**9.4.4.17 SCADA Interface**

The design shall provide remote control and monitoring of train control via the SCADA system. The design shall provide at least the following remote controls:

- Request, fleeting and canceling of routes for all wayside signals
- Request track and switch blocking
- Establish, change or cancel automatic terminal modes
- Move all switch machines
- Acknowledgement of alarms

The design shall provide at least the following indications and alarms:

- Occupancy of all track circuits, including overlays
- Wayside signal aspects
- Crossing gate status (all gates down)
- Switch position
- Switch locked
- Traffic direction
- Signal time lock
- Overrun indication
- All other warning indications necessary to alert personnel of possible problems or failures (such as battery/charger alarms, power off AC and DC).

- Intrusion and fire alarms and equipment trouble.

#### **9.4.5 Metro Red Line Expansion and Any New HRT Construction**

##### **9.4.5.1 General Requirements**

The signaling system shall provide the following functions:

- Interlocking control of switches and signals
- Safe routing of trains
- Safe separation of trains to prevent collisions and side swipes by physically separated operation on the main line, protected by vital systems
- Automatic Train Operation (ATO)

The signaling system and grade crossings shall comply with the AREMA Manual of Recommended Practices - Signals.

Automatic route setting shall be for normal train operation. Manual selection of routes shall be provided for abnormal train operation or when automatic routing is not desirable.

Bi-directional operation at full line speed and headway shall be provided throughout the main line. All sections under signal control shall be signaled such that, in the event either of the tracks in the double track sections is taken out of service, safe operations can be maintained.

The signal system shall provide continuous overspeed protection and speed commands (cab signal) operation, which shall prevent unsafe operation with respect to other trains, interlocking conditions, civil speed limits, and grade crossings.

The cab signal system shall impose speed restrictions due to civil/track speed limits. In the normal direction of traffic the following design requirements shall be followed:

- 
- Locate block limits in approach to and exit from civil speed restriction zone in accordance with requirements of Section 9.4.5.2.4.
- The maximum block length shall be 2,000 feet.
- All track circuits with a Maximum Authorized speed (MAS) exceeding 40 mph shall have at least one intermediate speed code before "STOP".
- All track circuits shall have a provision to allow for a manual downgrade to a more restrictive speed code via local control panel or hardware cards. Manual speed code selection shall not override safe train separation function of ATP.
- Exceptions to the above criteria shall be reviewed on a case-by-case basis.

##### **9.4.5.2 Safe Braking Distance Model**

###### **9.4.5.2.1 Introduction**

- A. SBD is the calculated distance that a worst-case train will travel between the time that a speed reduction is commanded at a block boundary and the speed reduction is achieved. See Contract Drawings for graphic representation. The SBD is the sum of the following distances:

1. Signal Recognition Distance - The distance traveled from the block boundary to the point at which the ATP vehicle equipment recognizes the more restrictive speed limit signal. Calculate the signal recognition distance on the basis of constant train speed for a maximum time period of 2 sec. Use the maximum train speed permitted by the overspeed tolerance for the ATP speed limit in effect just prior to the reception of the changed speed limit signal. See Table 3 for overspeed tolerance.
2. Overspeed Detection Distance - The distance traveled from the point at which the ATP vehicle equipment recognizes the change of the ATP speed limit to the point at which the ATP vehicle equipment commands traction power removal and a service brake application. The train achieves instantaneous maximum available acceleration per Table 1, with consideration for the effects of track geometry during this time interval. The worst-case overspeed detection time is 0.75 sec.
3. Brake Assurance Reaction Distance - The distance traveled from the point at which the ATP vehicle equipment commands a service brake application to the point at which the ATP vehicle equipment determines that the minimum safe deceleration rate has not been achieved and commands an emergency brake application. This time interval is 3.0 sec. maximum. This is inclusive of the traction power removal time which starts when overspeed is detected and continues until traction power is removed. The train removes traction power at a worse-case minimum jerk-limited rate of 1.8 mi/hr/sec<sup>2</sup>. Once tractive effort is reduced to zero, it remains at zero for the remainder of the interval. Base the initial acceleration on the available tractive effort per Table 1. The track geometry shall affect the acceleration throughout this period. For calculation purposes, the train resistance shall affect the acceleration when the tractive effort equals zero.
4. Emergency Brake Reaction Distance - The distance traveled from the point at which the ATP vehicle equipment commands an emergency brake application to the point at which emergency braking begins to build. Assume tractive effort is zero for the entire time interval, and base acceleration solely on the effects of train resistance and track geometry. This time interval is 0.4 sec.
5. Emergency Brake Build-up Distance - The distance traveled from the point at which emergency braking begins to build to the point at which emergency brakes are fully applied. The braking rate increases linearly from zero to 1.7 mi/hr/sec in 1.1 sec. Adjust deceleration for track geometry.
6. Emergency Braking Distance - The distance traveled from the point at which the emergency brakes are fully applied and the train begins to decelerate at the worst-case net braking rate of 1.7 mi/hr/sec to the stopping point. The braking rate shall be 1.7 mi/hr/sec for the entire interval. Adjust deceleration for track geometry.
7. Vehicle Overhang Distance - The distance comprising that portion of the leading train extending behind the center line of the rear-most axle, plus that part of the following train extending forward of the center line of the front-most axle for a total of 14 ft.
8. Vehicle Characteristics - In the SBD design, use the following vehicle



characteristics in all combinations to determine the longest braking distance:

Length: Two or six cars.

Car Weight: AW0 (78,000 lbs.) or AW3 (128,000 lbs.)

**TABLE 1, ACCELERATION RATES**

<u>Velocity (MPH)</u>	<u>Ideal Train Acceleration ft/s/s</u>	<u>SBD Model Acceleration ft/s/s</u>
1	2.7740	3.0514
2	2.9330	3.2263
3	4.0740	4.4814
4	4.0740	4.4814
5	4.0740	4.4814
6	4.0740	4.4814
7	4.0740	4.4814
8	4.0740	4.4814
9	4.0740	4.4814
10	4.0740	4.4814
11	4.0740	4.4814
12	4.0740	4.4814
13	4.0740	4.4814
14	4.0740	4.4814
15	4.0740	4.4814
16	4.0740	4.4814
17	4.0740	4.4814
18	4.0740	4.4814
19	4.0740	4.4814
20	4.0740	4.4814
21	4.0740	4.4814
22	4.0740	4.4814
23	4.0740	4.4814
24	4.0740	4.4814
25	4.0740	4.4814
26	3.9370	4.3307
27	3.8010	4.1811
28	3.6650	4.0315
29	3.5290	3.8819
30	3.3900	3.7290
31	3.2730	3.6003
32	3.1660	3.4826
33	3.0580	3.3638
34	2.9510	3.2461
35	2.8440	3.1284
36	2.7370	3.0107
37	2.6300	2.8930
38	2.5210	2.7731
39	2.4140	2.6554
40	2.3200	2.5520
41	2.0950	2.3045
42	1.9980	2.1978
43	1.9010	2.0911
44	1.8030	1.9833
45	1.7060	1.8766



TABLE 1. ACCELERATION RATES

Velocity (MPH)	Ideal Train Acceleration ft/s/s	SBD Model Acceleration ft/s/s
46	1.6090	1.7699
47	1.5120	1.6632
48	1.4150	1.5565
49	1.3180	1.4498
50	1.2500	1.3750
51	1.2070	1.3277
52	1.1500	1.2650
53	1.0940	1.2034
54	1.0380	1.1418
55	0.9820	1.0802
56	0.9270	1.0197
57	0.8710	0.9581
58	0.8150	0.8965
59	0.7580	0.8338
60	0.6960	0.7656
61	0.6520	0.7172
62	0.6070	0.6677
63	0.5390	0.5929
64	0.4840	0.5324
65	0.4290	0.4719
66	0.3900	0.4290
67	0.3350	0.3685
68	0.2790	0.3069
69	0.2520	0.2772
70	0.2000	0.2200
71	0.1980	0.2178
72	0.1960	0.2156
73	0.1940	0.2134
74	0.1920	0.2112
75	0.1900	0.2090
76	0.1880	0.2068
77	0.1860	0.2046

**TABLE 2, IDEAL TRAIN REACTION TIMES TO CODE CHANGES (Seconds)**

		TO (MPH)							
		0.0	8.0	9.0	25.0	40.0	45.0	55.0	70.0
FROM  (mph)	0.0	0.0	1.15	1.04	0.96	0.88	0.82	0.78	0.75
	8.0	3.30	0.0	2.94	2.94	2.94	2.94	2.94	2.94
	9.0	3.30	2.20	0.0	2.94	2.94	2.94	2.94	2.94
	25.0	3.30	2.20	2.09	0.0	2.94	2.94	2.94	2.94
	40.0	3.30	2.20	2.09	2.01	0.0	2.70	2.70	2.70
	45.0	3.30	2.20	2.09	2.01	1.93	0.0	2.59	2.59
	55.0	3.30	2.20	2.09	2.01	1.93	1.87	0.0	2.45
	70.0	3.30	2.20	2.09	2.01	1.93	1.87	1.83	0.0

**TABLE 3, SBD OVERSPEED LIMITS**

ATP Speed Limit. mph	Overspeed Tolerance, mph
70	-0, +3.0
55	-0, +2.5
45	-0, +2.0
40	-0, +2.0
25	-0, +1.5
9	-0, +1.0
8	-0, +1.0

**9.4.5.2.2 Train Resistance Factors**

A. Track Geometry Factors

Retarding or accelerating force of 20 lb/ton of vehicle weight per percent of grade, with consideration given to vertical alignment.

Retarding force of 0.8 lb/ton of vehicle weight per degree of horizontal curvature.

B. Vehicle Resistance Factors - Train resistance on level tangent track (to be considered only during coasting for SBD purposes):

Retarding force in lb, due to bearing friction and resistance proportional to weight:

$$FR_1 = N (116 + 1.3W)$$

Retarding force in lb, due to rolling friction and resistance proportional to velocity:

$$FR2 = N (0.045VW)$$

Retarding force in lb, due to wind resistance, lead vehicle:

$$FR3 = 0.0024 AV^2$$

Retarding force in lb, due to wind resistance, trailing vehicle:

$$FR4 = (N-1) (0.00034AV^2)$$

Average train resistance in lb per vehicle:

$$FR = [N (116 + 1.3W + 0.045VW) + 0.0024AV^2 + (N-1)0.00034AV^2]/N$$

Symbols:

W = Vehicle weight (ton)

V = Speed (mi/hr)

A = Vehicle frontal area = 98 ft<sup>2</sup>

N = Number of vehicles in train consist (2 or 6)

For use in vehicle resistance factors, the acceleration resistance due to vehicle inertia = 100 lb/ton/mi/hr/sec.

- C. Distributed Force - Calculate the forces due to train resistance and track geometry factors as either distributed point masses located at truck centers or as a uniformly distributed line mass.

#### 9.4.5.2.3 Speed Limits

- A. Maximum Authorized Speed - MAS is the highest ATP speed limit that can be transmitted in a block for the purpose of enforcing civil speed limits and station run-through speed.
- B. The MAS for approach to civil speed limit zones shall not exceed the SBD profile to achieve the speed limit at the start of the restriction using all track geometry and train resistance factors.
- C. Station run-through speed shall not exceed 45 mi/hr for an ideal train.
- D. Design Profile Speed - Design profile speed is the highest speed limit to be given in a block and is equal to MAS, except as otherwise indicated. Use the maximum design profile speed as indicated for each station-to-station zone to provide the least runtime even when the train may not achieve that velocity. Use the design profile speed for control line and headway requirements.

#### 9.4.5.2.4 Block Boundaries

- A. General - Locate block boundaries to ensure compliance with safety and headway requirements in addition to those specified herein.
- B. Impedance Bond Boundaries - Utilize impedance bonds to locate block boundaries at Insulated joints defining interlockings.
- C. Speed Restriction Zone Approach - Locate a block boundary in the normal direction of traffic on the approach to the zone with a more restrictive civil speed limit, in order to slow a worst-case train to the more restrictive speed when entering the zone. Locate this boundary no farther from the more restrictive zone than the SBD necessary to slow the train to the restricted speed plus 50 ft.

- D. Speed Restriction Exit - Locate a block boundary at the normal direction exit end of a speed restriction zone. Provide look-back capability so that as soon as the rear of the train crosses the block boundary it can receive the higher ATP speed code, providing SBD conditions permit an increased speed. If the exit from the speed restriction area would not result in a higher speed code for an ideal train due to approach of another speed restriction zone or station stopping profile, then a block boundary to define the exit from the speed restriction is not required. The look-back block boundary would be ideally located within the speed restriction zone at the distance that allows the rear of a train traveling at the ATP speed limit to reach the speed restriction velocity at the exit point of the speed restriction. This distance would also include the time required for the exited track circuit to pick and the time required for the train to recognize the increased speed code and apply acceleration. Locate the boundary within 50 ft. of the ideal boundary location in normal direction of travel.
- E. Station Speed Restriction - Locate a block boundary in the normal traffic direction approach to a station in order to slow an ideal train not stopping at the station to 45 mi/hr when entering the station platform. This boundary does not apply to locations where civil speed restrictions have already reduced the velocity to 45 mph or less.

#### 9.4.5.3 Civil Braking Distance Model

- A. The Civil Braking Distance (CBD) is the calculated distance that a train will travel between the time that a civil speed reduction is commanded until the required speed reduction is achieved. The train operator is in control of the speed with the cab signal system providing over-speed protection only. The CBD formula shall not be applied to safe train separation.
- B. The Civil Braking Distance (CBD) model shall be the same as the Safe Braking Distance (SBD) model, except:
  - 1. Overspeed Detection Distance shall be the distance traveled from the point at which the ATP vehicle equipment recognizes the change of the ATP speed limit to the point at which the ATP vehicle equipment commands traction power removal and a service brake application, without runaway acceleration. The worst-case overspeed detection time is 0.75 sec.
  - 2. Brake Assurance Reaction Distance and Emergency Brake Reaction Distance are replaced with Service Brake Reaction Distance
  - 3. Service Brake Reaction Distance - The distance traveled from the point at which the ATP vehicle equipment commands a service brake application to the point at which full service braking begins to build. Assume tractive effort is zero for the entire time interval, and base acceleration solely on the effects of train resistance and track geometry. This time interval is 3.4 sec.
  - 4. Emergency Brake Build-up Distance is replaced by Service Brake Build-up Distance.
  - 5. Service Brake Build-up Distance - The distance traveled from the point at which service braking begins to build to the point at which service brakes are fully applied. The braking rate increases linearly from zero to 2.0 mi/hr/sec in 1.1 sec.

Adjust deceleration for track geometry.

- 6. Emergency Braking Distance is replaced by Service Braking Distance.
- 7. Service Braking Distance - The distance traveled from the point at which the service brakes are fully applied and the train begins to decelerate at the worst-case net braking rate of 2.0 mi/hr/sec to the target speed. The braking rate shall be 2.0 mi/hr/sec for the entire interval. Adjust deceleration for track geometry.

**9.4.5.4 Cab Signal System**

**9.4.5.4.1 Functionality Overview**

The cab signal received on-board the car shall be interpreted as a speed limit, the aspect of which, shall be displayed to the operator.

Code rates and their meanings shall be:

<b>CODE RATE</b>	<b>INDICATION</b>
21.50 Hz	Proceed at 70 mph.
18.10 Hz	Proceed at 55 mph.
15.30 Hz	Proceed at 45 mph.
12.43 Hz	Proceed at 40 mph.
10.10 Hz	Proceed at 25 mph.
8.31 Hz	Proceed at 9 mph.
6.83 Hz	Proceed at 8 mph.
5.50 Hz	Stop and Stay
No Code	Stop and Proceed. Approaching a signal at stop or when occupancy exists ahead that requires immediate brake application to safely avoid a collision.

The carrier frequency shall be 2.34 kHz.

Dead sections, such as at insulated rail joints, shall be no greater than 14 feet in length.

**9.4.5.5 Train Detection**

The signaling system shall detect all cars operating independently or in consist, and any other rail vehicle present, except hi-rail vehicles.

The presence of a rail vehicle in a section of the route shall be detected continuously by means of track circuits.

Detection of the occupation of the track circuit shall be fail-safe, such that a de-energized position is interpreted as an occupation of the track circuit.

In the event of a temporary loss of detection, the design shall ensure that indication of the presence of a rail vehicle in a section will be maintained while a rail vehicle is actually in the section.

If a rail vehicle is parted in an unscheduled manner, the signal system shall ensure that all

parts of the rail vehicle are detected. The signal system shall ensure that safe separation is maintained between the parted vehicle and all other rail vehicles.

The minimum effective length of a track circuit shall be longer than the maximum inner wheelbase of all vehicles used on this track.

For track circuits used to control signals and locking functions, the minimum shunt sensitivity shall be 0.25 Ohms. The shunting requirements shall be met for ballast conditions of 5 ohms per thousand feet or greater.

#### **9.4.5.6 Broken Rail Detection**

Broken rail detection shall be provided throughout. A broken rail shall de-energize the associated track circuit.

#### **9.4.5.7 Route Setting**

There shall be three methods for control of train movement through the signalized sections, as described below.

##### **9.4.5.7.1 Automatic Route Setting**

Routes shall normally operate automatically by signal and switch control subsystems responding to the approach of the train.

In normal operation, routes shall clear automatically for consists without intervention by the train operator. At terminal stations trains shall be normally routed reverse across before reaching the station as the preferred route, or the normal direction route if the preferred platform is occupied.

##### **9.4.5.7.2 Selection of Routes from the Train**

Train-to-Wayside Communication route section shall be provided at all interlocking signals.

##### **9.4.5.7.3 Local Route Selection Capability**

Local control capability shall be provided to ensure the safe operation of trains by means of Local Control Panels (LCP) in each signal house.

The LCP shall indicate track circuit occupancy, signal status, switch position and correspondence, switch locking, traffic direction, manual control, automatic control, and crossing gate position, speed restriction enabled, AC alarm, DC alarm, communication failure alarm, system failure (Electrologixs, VHLC, iVPI, or Microlok), and all indications described in the specifications.

#### **9.4.5.8 Wayside Signals**

##### **9.4.5.8.1 Main line**

Wayside color signals shall be provided to indicate movement authority, block occupation and route locking information to train operators. Signals shall be installed to govern movements into and through interlocking limits.

Wayside color signals shall show the following aspects, which are in compliance with Metro rules:

<u>Aspect</u>	<u>Meaning</u>
Red	Stop
Flashing Red	STOP and contact ROC. Proceed when authorized by ROC.
Flashing Yellow	Proceed on diverging route into reverse traffic.
Yellow	Proceed on diverging route into normal traffic.
Flashing Green	Proceed on normal route into reverse traffic.
Green	Proceed on normal route into normal traffic.

Indication on signals or switches shall be fail-safe, such that no less restrictive aspect is shown than intended.

Wayside signals shall be located such that they are sufficiently visible to preclude confusion with signals governing the operation of motor vehicles, and similarly do not confuse motor vehicle drivers. When viewed from a height of 7 feet above top of rail, at a distance of 500 ft, lenses shall present a distinct aspect under the most adverse operating conditions.

Provide a signal number plate for each signal. The signal number plate shall be placed under the lowest signal lens in the assembly. Signal plates shall meet the requirements of the AREMA Manual of Recommended Practices – Signals. The alphanumeric characters shall be a minimum of 3 inches high.

**9.4.5.9 Interlockings**

As a minimum, the following locking functions shall be provided for powered switch interlockings:

- a) Switch locking - A locking function shall ensure that a signal governing a switch or combination of switches shall only show a less restrictive aspect than "stop", when all switches are in the correct position.
- b) Automatic Block locking - A home signal governing a block shall only show a less restrictive aspect than "stop", when the entire block is unoccupied by any trains or vehicles. This shall be controlled automatically by means of track circuits throughout the entire block.
- c) Route locking - Route locking shall lock switches within a route after a signal has been requested for train movement onto that route, and shall prevent clearing of opposing and conflicting signals within the interlocking. Route locking shall be in effect when approach locking is in effect, and it shall remain in effect until the rear of the train has cleared the route.

Switches, which are part of the route, and switches or signals, which are protecting against flanking (side-swipe), shall be disabled from moving when the route is locked. Signals protecting this route shall be prevented from showing aspects other than stop.

- d) Approach locking - Approach locking shall lock switches within a route governed by a cleared wayside signal to prevent clearing wayside signals for opposing or conflicting

routes.

- e) Time locking - Time locking shall ensure that all switches and signals forming a route, and those protecting it, remain in position and locked for a predetermined time after the entry signal has been caused to display its most restrictive aspect again.
- f) Traffic locking - Setting and locking of a route shall be prohibited unless the opposing signals show the most restrictive aspect. The signal system shall furthermore prevent any trains simultaneously entering the same block section from different directions or tracks.

Independent of any route locking function, the movement of any powered switch shall be prevented when track occupancy is detected in the track section in which that switch is located.

The switch locking function shall have 5 seconds loss of shunt protection. However, sectional release shall be provided where practicable, to support headways through junctions.

Any failure, including loss of power, to any part of an interlocking shall not result in the premature release of any locking function.

Overrun detection shall be provided for every interlocking signal.

#### **9.4.5.10 Track Switches**

All track switches shall be powered and interlocked. They shall normally be set and locked automatically. All route-setting functions defined in Section 9 shall apply. An over-switch (OS) track circuit shall be provided, occupation of which shall prevent powered movement of the switch.

A manual switch setting facility shall be provided at powered switch locations. The placing of a powered switch into manual operation shall result in loss of indication. Signals shall revert to their most restrictive aspect in the event of loss of indication of switch position.

Switch and lock mechanisms shall meet or exceed the recommendations of the AREMA Manual of Recommended Practices—Signals. The electrical, electromechanical or mechanical locking equipment shall prevent switch point movement when the switch points are in full normal or full reverse position.

Parts of switch operating layouts shall be interchangeable between similar layouts.

#### **9.4.5.11 Traction Return Bonding**

The design shall provide impedance bonds and running rail continuity and cross bonding sufficient to comply with the traction return power requirements.

The design shall ensure that no single failure, including broken rail or loss of a bonding cable, shall result in loss of traction return capability through loss of continuity or failure due to overheating.

Traction power return capability shall be provided on all tracks regardless of whether OCS is



present or not.

**9.4.5.12 Event Recorders**

AREMA recommended event recorders that store information for future playback shall be provided for vital systems to record changes in state of the vital systems, their devices, all alarms, status of all control and indication history.

Each recorder shall be standalone, capable of recording up to one week of events assuming a train movement in each direction at design headway 24 hours a day, 7 days a week. Each recording device shall provide access to the data through a standard USB interface port.

Event recorder time clock shall be synchronized with that of the solid state interlocking equipment. At any time, there shall be no more than a one second differential between the two time clocks

**9.4.5.13 Environmental Requirements**

All equipment shall meet the environmental provisions of the AREMA ATCS environmental specifications and environmental requirements specified in these Contract Documents.

**9.4.5.14 Power Supply**

All housings shall be equipped with an external socket for the connection of a mobile generator. Signaling power supplies shall not be used for any purpose other than to power signaling equipment. In case of failure of the primary power source, backup power supply shall be provided to ensure safe train operation as follows:

Vital equipment	4 hours minimum
Non-vital equipment	4 hours minimum
Switch machines	4 hours minimum at all interlockings

**9.4.5.15 Lightning Protection**

Lightning protection shall be provided for all equipment, which could be damaged by electrical transients.

**9.4.5.16 Design Integrity**

The system shall be designed and operated in a safe manner. Failure of the system shall not compromise the safety of train operation, road traffic or pedestrians.

Any circuit directly affecting the safety of train movement shall be considered “vital”. Circuits performing functions of control, indication, communication, and other tasks, which do not directly affect the safety of train movement, shall be considered “non-vital”.

All vital components shall be highly reliable, of proven design and have predictable failure modes, such that no single failure shall create a less restrictive state.

The signal system logic and its components shall be designed to meet the following:

- a) All vital components shall be designed so that restrictive (rather than permissive) actions occur when a component fails.
- b) All vital control logic shall be designed such that, if interrupted or de-energized, it shall cause the controlled function to assume its most restrictive condition.
- c) All relays or solid-state equivalents being energized by a vital circuit shall be vital units. All contacts used within any vital circuit shall be contacts of vital relays.
- d) All errors of hardware and software that may compromise vital data, whether stored within a logical process, sampled as digital or analog inputs, or produced as digital or analog output, shall result in a safe system state.

Non-vital circuits may use non-vital relay or solid-state technology. Failures of non-vital equipment shall not affect the safety of the system. Non-vital systems shall interface with vital systems in a manner, which isolates the vital systems from malfunctions of the non-vital systems.

Vital microprocessor systems may be used.

The use of radio, land cable, or any combination, which forms a serial communication channel for the signal system, shall not be considered vital in itself. Design techniques shall be employed such that the equipment at each end of the communication link shall be capable of detecting errors in the data transmitted and received, such that system operation remains safe.

#### **9.4.5.17 Materials and Equipment**

##### **9.4.5.17.1 General**

Assemblies and components used to perform identical functions within the system shall be mechanically and electrically interchangeable. Standard commercially available equipment and material from multiple sources shall be used where practicable.

All wayside equipment shall be secured and protected by the use of tamper-resistant covers. Where deemed appropriate by the Designer, further protection shall be provided with intrusion detection devices.

All cables and wires shall be suitably protected. Conduits shall be provided under tracks, along bridges and through roadways, to meet AREMA recommendations. All material and equipment furnished shall be new and standard products of manufacturers regularly engaged in the production of like equipment, and shall be the latest design, which complies with the requirements of these Contract Documents.

##### **9.4.5.17.2 Equipment Location**

Signal equipment shall be located along the wayside only where necessary. All other equipment shall be located on the outer edge of the right-of-way, in easily accessible equipment housings.

Signal houses and rooms shall be provided with a fire and intrusion detection system.

#### **9.4.5.17.3 Equipment Housings**

All signal equipment housings shall include all required environmental controls to facilitate maintenance and operation, including any necessary heating, ventilation and air conditioning.

As a minimum, air conditioning and forced air ventilation shall be provided at every enclosure. Heat load calculations shall support any heating, ventilation and air conditioning (HVAC) installation. Designed inside (indoor) temperature shall be less than a maximum operating temperature of any equipment to be installed in the case.

The signal equipment shall be capable of operation in the event of a failure of any environmental control subsystems.

All equipment-housing openings shall be screened or sealed to prevent entry of animals and insects to the extent practicable. All entryways shall be sealed following installation of cables and wiring entering the housing.

All insulation material used to line the interior of equipment housing walls, doors and roofs shall be flame retarding and non-electrically conductive, and shall not introduce a hazard of any type.

All equipment housings shall be designed to accommodate possible future expansion of equipment space by 30%.

#### **9.4.5.17.4 Security of Equipment**

All signal equipment housings, cases, junction boxes, switch mechanisms, and signals shall be secured with an appropriate security device.

Provide intrusion detection in all rooms, bungalows and cases housing train control equipment.

#### **9.4.5.17.5 Train Control Logic Security**

Whenever microprocessor logic is used, both for vital and non-vital train control purposes, implement security procedures to prevent unauthorized access to, modifications of, and operation of such.

#### **9.4.5.17.6 Maintainability**

The signaling equipment shall be designed and constructed to facilitate quick and easy troubleshooting and module replacement. The design shall require a minimum of testing following module replacement.

Built-in indicators or meters shall be provided for routine maintenance, testing, and diagnostic purposes. The use of plug-in devices, such as laptop computers for the downloading of data from devices, including microprocessor interlockings, shall be allowed in addition to a basic set of fault indicators. As a minimum, LED indicators shall be provided for circuit boards to indicate the health status of a circuit board. A failed indication shall signify to a maintainer that the board should be replaced.

#### 9.4.5.18 SCADA Interface

The design shall provide remote control and monitoring of train control via the SCADA system. The design shall provide at least the following remote controls:

- Request, fleeting and canceling routes for all wayside signals
- Request track and switch blocking
- Establish, change or cancel automatic terminal modes
- Move all switch machines
- Acknowledgement of alarms

The design shall provide at least the following indications and alarms:

- Occupancy of all track circuits, including overlays
- Wayside signal aspects
- Switch position
- Switch locked
- Traffic direction
- Signal time lock
- Overrun indication
- All other warning indications necessary to alert personnel of possible problems or failures (such as battery/charger alarms, power off alarm AC and DC).
- Intrusion and fire alarms and equipment trouble.

#### 9.4.5.19 ATO Subsystem

Provide wayside solid state wayside ATO package that is compatible in features and performance with the existing ATO system. This includes:

- ATO signal generators
- Program Station Stop system that is compatible with existing MRL fleet and wayside system

### 9.4.6 Yard train control system

#### 9.4.6.1 Yard Train Control System General Requirements

The following section describes design criteria pertaining only to the train control system within a yard. The yard signaling system shall be designed to provide safe routing of trains with maximum operational flexibility within the yard confines. As a minimum it shall have the following functions:

- Interlocking control of switches and signals
- Protection of highway (grade) crossings against road/rail collisions.

All signal and train control equipment necessary to enable a train to clear the main line shall comply with mainline requirements.

The mainline signal system shall control alignment of routes into yard and from yard to mainline.

#### **9.4.6.2 Wayside Signals**

LED wayside color signals shall be provided to indicate movement authority, and switch position information to train operators. Signals shall be installed to govern movements into, within, and out of the yard limits.

Provide a signal number plate for each signal. The signal number plate shall be placed under the lowest signal lens in the assembly. Signal plates shall meet the requirements of the AREMA Manual of Recommended Practices – Signals. The alphanumeric characters shall be a minimum of 3 inches high.

Signals, authorizing train movements into mainline territory shall adhere to the requirements of mainline train control design criteria.

#### **9.4.6.3 Train-to-Wayside Communication**

The Train-to-Wayside Communication (TWC) system shall be compatible with Hanning & Kahl HCS-V.

TWC transponders shall be provided in approach to all wayside signals.

#### **9.4.6.4 Train Detection**

All train detection outside of storage tracks and car wash facilities shall be failsafe. Track circuits in the storage tracks, car wash facilities, and track circuit repeaters may be non-vital provided that no track repeater contacts are used in detector locking circuits.

The signaling system shall detect all cars operating independently or in consist, and any other rail vehicle present, except hi-rail vehicles. This detection requirement applies to all yard trackage.

Occupancy of storage tracks designed to accommodate more than one maximum car length train shall indicate section of storage track being occupied.

Single rail, power frequency, vane-relay based track circuits shall be used in all over-switch (detector) track circuits. Indicating-type track circuits are permitted to be installed on storage tracks only. Double-rail track circuits are to be used for mainline interface and on test tracks.

The minimum effective length of a track circuit shall be longer than the maximum inner wheelbase of all vehicles used on this track.

#### **9.4.6.5 Route Setting**

There shall be three methods for control of train movement through the signalized sections, as described below:

##### **9.4.6.5.1 Yard Control**

Routes within the yard limits shall normally be controlled by yard tower

##### **9.4.6.5.2 Selection of Routes from the Train**

Train-to-Wayside Communication route selection shall be provided at all interlocking signals.

**9.4.6.5.3 Local Control**

Local control capability shall be provided to ensure the safe operation of trains by means of Local Control Panels (LCP).

At a minimum, the LCP shall indicate track circuit occupancy, signal status, switch position and correspondence, switch locking, traffic direction, manual control, automatic control, and crossing gate position, AC Alarm, DC Alarm, Communication failure Alarm, Microprocessor System failure (Electrologixs, VHLC, iVPI, or Microlok), Intrusion detection.

These indications shall also be available at Yard Control Tower.

**9.4.6.6 Yard Dwarf Signals:**

- a) Dwarf signals shall be either a 2 head or 3 head unit. The signal shall be used to display permissive aspects at the entrance to each Yard interlocking when routes have been established within the Yard.
- b) Dwarf signal number plates shall be provided below the lowest dwarf signal lens in the assembly. Signal plates shall meet the requirements of the AREMA C&S Manual and contain alphanumeric characters a minimum of 3 inches high.
- c) Aspects displayed shall be as follows

<u>Aspect</u>	<u>Meaning</u>
Green	First switch point in route is in the normal position. Proceed Yard mode of Operations.  First switch point in route is in the reverse position. Proceed Yard mode of Operations.
Red	Stop. Contact Yard Control.

**9.4.6.7 Interlockings**

As a minimum, the following locking functions shall be provided for powered switch interlockings:

- a) Switch locking - A locking function shall ensure that a signal governing a switch or combination of switches shall only show a less restrictive aspect than "stop", when all switches in a route are locked in their correct position.
- b) Route locking - Route locking shall lock switches within a route after a signal has been requested and switches are in their proper position. Route lockers shall prevent clearing of opposing and conflicting signals within the interlocking. Route locking

- shall be in effect when approach locking is in effect, and it shall remain in effect until the rear of the train has cleared the route.
- c) Switches, which are part of the route, and switches or signals, which are protecting against flanking (side-swipe), shall be disabled from moving when the route is locked. Signals protecting this route shall be prevented from showing aspects other than stop.
  - d) Approach/Time locking – Approach/Time locking shall maintain switch locking for a predetermined time after a signal has been canceled and there is a train on approach to the signal. .
  - e) Detector Locking – Detector locking shall prevent movement of a switches within an interlocking when any of the track circuits in the interlocking are occupied. Detector locking circuits shall only use contacts from the ac vane track relay. Contacts from non-vital repeaters shall not be used in switch locking circuits.

Detector tracks shall have 5 seconds loss of shunt protection. Sectional release shall be provided where practicable.

Any failure, including loss of power, to any part of an interlocking shall not result in the premature release of any locking function.

#### **9.4.6.8 Track Switches**

All track switches shall be powered and interlocked. They shall normally be set and locked automatically. An over-switch (OS) track circuit shall be provided, occupation of which shall prevent powered movement of the switch.

A manual switch setting facility shall be provided at powered switch locations. The placing of a powered switch into manual operation shall result in loss of indication. Signals shall revert to their most restrictive aspect in the event of loss of indication of switch position.

Switch and lock mechanisms shall meet or exceed the recommendations of the AREMA Communications & Signals Manual of Recommended Practice, Part 4.2.5.

Parts of switch operating layouts shall be interchangeable between similar layouts.

All switch machines in the yard shall have battery backup of 4 hours and have hand throw capability.

Mainline switch machines shall be installed for all track switches leading to mainline tracks.

#### **9.4.6.9 Traction Return Bonding**

The design shall provide impedance bonds and running rail continuity and cross bonding sufficient to comply with the traction return power requirements.

The design shall ensure that no single failure, including broken rail or loss of a bonding cable, shall result in loss of traction return capability through loss of continuity or failure due to overheating.

Traction power return capability shall be provided on all tracks regardless of whether they are electrified or not.

#### **9.4.6.10 Event Recorders**

AREMA recommended event recorders that stores information for future playback shall be provided for vital systems, including grade crossings, to record changes in state of the vital systems, their devices, all alarms, status of all control and indication history. Each recorder shall be standalone capable of recording up to 1 week of events assuming a train movement in each direction every 3.5 minutes continuously. Each recording device shall provide access to the data through a standard USB interface port.

The event recorders must be time synced with solid state interlocking controllers. At any time, there shall be no more than a 1 second differential between the two time clocks

#### **9.4.6.11 Environmental Requirements**

All equipment shall meet the environmental provisions of the AREMA ATCS environmental specifications and environmental requirements specified in these Design Criteria.

#### **9.4.6.12 Power Supply**

All housings shall be equipped with an external socket for the connection of a mobile generator. Signaling power supplies shall not be used for any purpose other than to power signaling equipment.

#### **9.4.6.13 Lightning Protection**

Lightning protection shall be provided for all equipment, which could be damaged by electrical transients.

#### **9.4.6.14 Design Integrity**

The system shall be designed and operated in a safe manner. Failure of the system shall not compromise the safety of mainline train operation, road traffic or pedestrians.

Any circuit directly affecting the safety of mainline train movement shall be considered "vital". Circuits performing functions of control, indication, communication, and other tasks, which do not directly affect the safety of train movement, shall be considered "non-vital".

All vital components shall be highly reliable, of proven design and have predictable failure modes, such that no single failure shall create a less restrictive state.

The signal system logic and its components shall be designed to meet the following:

- a) All vital components shall be designed so that restrictive (rather than permissive) actions occur when a component fails.
- b) All vital control logic shall be designed such that, if interrupted or de-energized, it shall cause the controlled function to assume its most restrictive condition.
- c) All relays or solid-state equivalents being energized by a vital circuit shall be vital



units. All contacts used within any vital circuit shall be contacts of vital relays.

- d) All errors of hardware and software that may compromise vital data, whether stored within a logical process, sampled as digital or analog inputs, or produced as digital or analog output, shall result in a safe system state.

Non-vital circuits may use non-vital relay or solid-state technology. Failures of non-vital equipment shall not affect the safety of the system. Non-vital systems shall interface with vital systems in a manner, which isolates the vital systems from malfunctions of the non-vital systems.

The use of radio, land cable, or any combination, which forms a serial communication channel for the signal system, shall not be considered vital in itself. Design techniques shall be employed such that the equipment at each end of the communication link shall be capable of detecting errors in the data transmitted and received, such that system operation remains safe.

System such as train-to-wayside communication, local control panel and SCADA shall have a dedicated link to train control logic.

#### **9.4.6.15 Materials and Equipment**

##### **9.4.6.15.1 General**

Assemblies and components used to perform identical functions within the system shall be mechanically and electrically interchangeable. Standard commercially available equipment and material from multiple sources shall be used where practicable.

All wayside equipment shall be secured and protected by the use of tamper-resistant covers. Where deemed appropriate by the Designer, further protection shall be provided with intrusion detection devices.

All cables and wires shall be suitably protected. Conduits shall be provided under tracks, along bridges and through roadways, to meet AREMA recommendations. All material and equipment furnished shall be new and standard products of manufacturers regularly engaged in the production of like equipment.

##### **9.4.6.15.2 Equipment Location**

Signal equipment shall be located along the wayside only where necessary. All other equipment shall be located on the outer edge of the right-of-way, in easily accessible equipment housings.

Signal houses and rooms shall be provided with a fire and intrusion detection system.

Signal masts, grade crossing gates, flasher masts, cantilever signal masts and all concrete signal structures shall follow CPUC GO 75 and City requirements for these structures.

##### **9.4.6.15.3 Equipment Housings**

All signal equipment housings shall include all required environmental controls to facilitate maintenance and operation, including any necessary heating, ventilation and air

conditioning. As a minimum, air conditioning and forced air ventilation shall be provided at every enclosure. Heat load calculations shall support any heating, ventilation and air conditioning (HVAC) installation.

The signal equipment shall be capable of operation in the event of a failure of any environmental control subsystems. Houses, cases and junction boxes shall be steel or aluminum. Signal houses and cases containing electronic equipment shall be coated with reflective paint.

All equipment-housing openings shall be screened or sealed to prevent entry of animals and insects to the extent practicable. All entryways shall be sealed following installation of cables and wiring entering the housing.

All insulation material used to line the interior of equipment housing walls, doors and roofs shall be flame retarding and non-electrically conductive, and shall not introduce a hazard of any type.

Doors of housings shall be capable of being secured by a standard padlock and equipped with a weatherproof seal.

All equipment housings shall be designed to accommodate possible future expansion of equipment space by 30%.

#### **9.4.6.15.4 Security of Equipment**

All signal equipment housings, cases, junction boxes, switch mechanisms, and signals shall be secured with an appropriate security device.

Provide intrusion detection in all rooms, bungalows and cases housing train control equipment.

#### **9.4.6.15.5 Train Control Logic Security**

Whenever microprocessor logic is used, both for vital and non-vital train control purposes, implement security procedures to prevent unauthorized access to, modifications to and operation of such.

#### **9.4.6.15.6 Maintainability**

The signaling equipment shall be designed and constructed to facilitate quick and easy troubleshooting and module replacement. The design shall require a minimum of testing following module replacement.

Built-in indicators or meters shall be provided for routine maintenance, testing, and diagnostic purposes. The use of plug-in devices, such as laptop computers for the downloading of data from devices, including microprocessor interlockings, shall be allowed in addition to a basic set of fault indicators. As a minimum, LED indicators shall be provided for circuit boards to indicate the health status of a circuit board. A failed indication shall signify to a maintainer that the board should be replaced.

## 9.5 COMMUNICATIONS - GENERAL

### 9.5.1 Introduction

This section describes the criteria for design of the communications system and associated subsystems, including specific requirements of all subsystems and their relationship to other communications subsystems and other systemwide elements of the LRT and HRT System Projects.

The communications system shall provide the necessary subsystems to support the total operational requirements of the LRT and HRT System. The following subsystems and/or functions shall be considered part of the communications system and its design; including certain requirements related to expanding the subsystems to fulfill future needs:

- Radio
- Telephone (TEL)
- Transit Passenger Information System (TPIS) including Public Address (PA), Visual Message Signs (VMS)
- Closed Circuit Television (CCTV)
- Cable Transmission System (CTS)
- Supervisory Control and Data Acquisition (SCADA)
- Intrusion Detection and Controlled Access
- Central Control Consoles and Displays/Rail Operations Control (ROC)
- Gas Monitoring
- Seismic Detection
- Fire Alarm
- Facility and Emergency Management (F&EM) System
- Communications Power System

The above subsystem design requirements are detailed in the following sections of this document. Communications requirements for any communications based Train Control System are not contained herein.

The Rail Operations Control (ROC) will contain the necessary displays, control consoles, communications apparatus and the operating personnel responsible for the overall safety and security of passengers and the daily operations of the trains, stations and all supporting wayside apparatus. The ROC will serve as the focal point from which all Rail Transit System operations will be supervised, regulated and controlled.

Yard Control shall contain the necessary displays, control panels, communications apparatus and personnel to manage train movements and consists within the Yard.

Maintenance Control will be responsible for vehicle, personnel, and inventory control within the shop, personnel, maintenance equipment and inventory control within the LRT and HRT System, and communications between the shop and operations facilities, including Central Control and Yard Control. In addition, it will have maintenance-oriented management information services including vehicle and other system apparatus histories inventory analysis, and maintenance forecasting.

The Communications system shall consist of voice, video, and data circuits connecting the ROC with stations and other areas within the LRT and HRT systems. These functions shall be provided by communications network elements: radio; telephone; transit passenger information system; closed circuit television; cable transmission; supervisory control and data acquisition; intrusion detection and access control; gas monitoring and seismic detection; fire alarm; facility and emergency management; ROC and other subsystems equipment. These elements are described in the following paragraphs.

- A. Radio transmission shall provide the primary voice communications services for all areas. Two-way voice communications via radio shall serve trains and maintenance vehicles and portables with channels provided for operations, maintenance, security and fire/police emergency functions.
- B. The telephone service shall include emergency, maintenance, administrative telephones, and passenger assistance intercom at passenger stations, wayside, the ROC, and the Yard, served by Metro telephone system. In keeping with regulatory practice, all emergency and patron assistance telephone communications shall be recorded.
- C. Transit Passenger Information System (TPIS) includes Public Address (PA) and Visual Message System (VMS). PA services shall provide a fully supervised PA subsystem at each passenger station, the Yard and Shop buildings with access and control from various locations. The PA subsystem at the Yard and Shop buildings shall allow announcements from designated Yard and Shop phones to be directed to any one or multiple simultaneous zones. VMS, compliant with ADA Accessibility Guidelines requirements, shall provide safety and operations related messages to the traveling public at selected locations. The Transit Passenger Information System (TPIS) shall provide multi-media communications at each passenger station and other selected locations.

The TPIS shall integrate PA and VMS with full-color flat panel displays to provide routine announcements, emergency warning, advertising and other non-interactive multi-media audio-visual information in full compliance with applicable fire and ADA regulations.

- D. Closed Circuit Television (CCTV) shall provide means of surveillance of passenger stations, the vehicle storage area, and other areas as required.
- E. The Cable Transmission System (CTS) shall provide the primary means of information transmission between the ROC, passenger stations, wayside facilities (as required), and the Yard and Shop. Signals, Traction Power and Communications Systems shall each be considered stand-alone infrastructure only sharing the project duct bank. Each system shall utilize separate cable and ducts within the duct bank. When there is a requirement for localized inter-system communications a dedicated cable shall be utilized.
- F. The Supervisory Control and Data Acquisition (SCADA) subsystem shall provide a master control station at the ROC and wayside interfaces for remote monitoring and control of train operations, traction power, station and wayside facilities.
- G. Intrusion Detection and Controlled Access

The Intrusion Detection and Controlled Access shall provide a master station at the ROC and remote wayside devices for remote monitoring and control of secure facilities access.

- H. Rail Operations Control (ROC)

The ROC subsystem shall provide unique equipment to support other systems, such as traction power, train control (TC), and the Environmental Control System (ECS). Included in this location are data processing equipment, control consoles, radio support interface equipment, Metro telephone system, network equipment for CTS, voice logging recorders, video monitors and recorders, data recorders, displays, and control panels.

- I. Gas Monitoring system (For underground systems)

A fully supervised gas monitoring subsystem shall be installed as required by results of soil sample test conducted during station construction and compliance with the Environmental Impact Study (EIS). Gas monitoring controller equipment, integrated with the station fire alarm system and ROC SCADA, shall be located in the train control and communications (TC&C) room and communicate with sensor heads installed at designated locations as necessary for the detection of the presence of specific gases at alarm concentrations.

- J. Seismic Detection System

The Seismic Detection Subsystem shall provide event detection alarms to the ROC.

- K. Fire Alarm System

The Fire Alarm system shall provide alarm annunciation to the Fire Alarm Control Panel (FACP), Emergency Management Panel (EMP) and ROC as well as fan and damper shutdown, elevator control, fire suppression activation, and evacuation by zone (all, as applicable). The fire control panel will typically be located in the TC&C Room.

## L. Facility and Emergency Management (F&amp;EM) System

The Facility and Emergency Management System includes high availability F&EM PLC, Emergency Management Panel (EMP), Auxiliary Emergency Management Panel (AEMP), and CCTV jack box. EMPs shall be provided in underground and aerial stations in accordance with Fire/Life Safety Criteria. These panels shall provide access to intrusion alarms, remote graphical fire annunciation, telephone, public address, elevator, emergency ventilation controls, and CCTV monitoring in a single panel to permit their use as a consolidated command post in event of emergency conditions in stations/tunnels.

## M. Communications Power System

All Communications system equipment shall be powered from Un-interruptible Power Supplies (UPS) or floating battery systems. (See Facilities - Electrical criteria.)

All communications equipment shall be capable of start-up following a power outage without reinitialization and with full status memory and process recall, with power from battery or from inverter sources.

**9.5.2 General Design Criteria**

## A. General

1. Standard commercial devices shall be used when such apparatus, software and materials meet the stated design criteria. Equipment assemblies, where required, shall be constructed using only standard off-the-shelf equipment.
2. Within each Communications subsystem for each segment, like functions shall be performed by identical units. In no case shall the apparatus or hardware used in one portion of a segment's subsystem be different from that used in another portion to perform the same function under similar operation and environmental conditions. Due to technological advancements, parts availability and other restrictive factors functional equivalent equipment may be used between segments.
3. Modular design shall be employed. Electrical and mechanical components shall be organized in cabinet-mounted plug-in assemblies. The mixing of equipment associated with two subsystems in one plug-in assembly shall not be permitted. Apparatus serving similar functions shall be in the same relative location in all cabinets, wherever practicable.
4. Cabinets, racks and battery racks shall be protected to seismic codes of the State of California as applicable.
5. All communications equipment located in the passenger stations, wayside, ROC and the Yards and Shops shall be powered from un-interruptible power sources or DC back-up battery systems.
6. CIC enclosures or any enclosure housing active equipment shall not be used as a junction box for thru routing of cables. Only those cables that terminate in the enclosure shall enter the enclosure.

7. All communications equipment shall be clearly labeled such that the nomenclature is visible from the front with the normal operating covers on the devices.
  - a. All fiber optic patch panels, fiber splice trays, power supplies, frame blocks, protector blocks, shall be labeled in a manner that is visible to a person standing in front of the device.
  - b. All cross-connect panels shall be clearly labeled.
  - c. All fiber optic patch panels and main distribution frame shall be clearly labeled on the non removable portion of the shelf and on the front cover whether removable or not as to the cable number, the route, and where the cable goes or distant end.
  - d. All other equipment, as a minimum, shall be labeled on the front cover as to what the device is.
  - e. All cable terminations shall have cable tags identifying the cable number, the number of copper pairs or fiber strands in the cable, the distant end (where the cable goes). Cable identification shall match with the as-built drawings.
  - f. All punch down or cross-connect blocks and protected terminal blocks shall be labeled on the front of the blocks with the cable number, the number of pairs in the cable, the distant end (where the cable goes) and the route.
  - g. All Communications Interface Cabinets, located outside of TC&C room or C&S room, shall be mounted and bolted to 6" height reinforced concrete pad which is poured above ground.
  - h. In addition to Item a through Item g above, all racks at the Central Control communications equipment room shall have identification at the top of the rack as to what LRT and HRT line the equipment is associated with. At any location where communications equipment from different Metro Transit Systems reside in the same room, all racks shall have line or project identification at the top of the rack.
8. External communications conduits shall stub up 4" above the floor in a single concentrated area or enter from a single cable vault. Cable entry shall be directly adjacent to and terminate at a building entrance block with protectors adequately rated for each utilized conductor.
9. Cables running in cable tray shall be protected by split innerducts. Non-ruggedized fiber optical cable shall be inside the innerduct in cable tray. Outdoor ruggedized cables are required to use for outside plant.
10. Software for systems shall be an integration of commercially available off-the-shelf (COTS) products. Custom software development shall only be considered where there exist no available COTS solution is available and shall be approved by Metro.

#### B. Electromagnetic Compatibility



1. Electromagnetic compatibility (EMC) control shall insure that all Communications subsystems operate in their intended electromagnetic environments without either causing or suffering harmful interference because of electromagnetic emission or response. A primary objective shall be to develop signal levels, apparatus, components, and installation parameters to assure an electromagnetically compatible system. This objective shall be achieved through coordination of Communications system apparatus selection, design and installation with other electromagnetic equipment, such as the communication equipment (radio, CCTV, etc.), traction power system, AC power distribution system, vehicle propulsion apparatus, train control system, and other nearby facilities. The approach to implementation of EMC shall include control of:
  - a. Conductively coupled interference
  - b. Interference coupled through common impedance
  - c. Interference coupled through radiated electric fields
  - d. Interference coupled through radiated magnetic fields.
2. The control of electromagnetic interference shall employ, but not be limited to, the following methods:
  - a. Shielding
  - b. Grounding
  - c. Balancing
  - d. Filtering
  - e. Isolation
  - f. Separation and orientation
  - g. Circuit impedance level control
  - h. Cable design
  - i. Frequency management
  - j. Power level

### C. Grounding

#### 1. Safety and Facilities Grounding

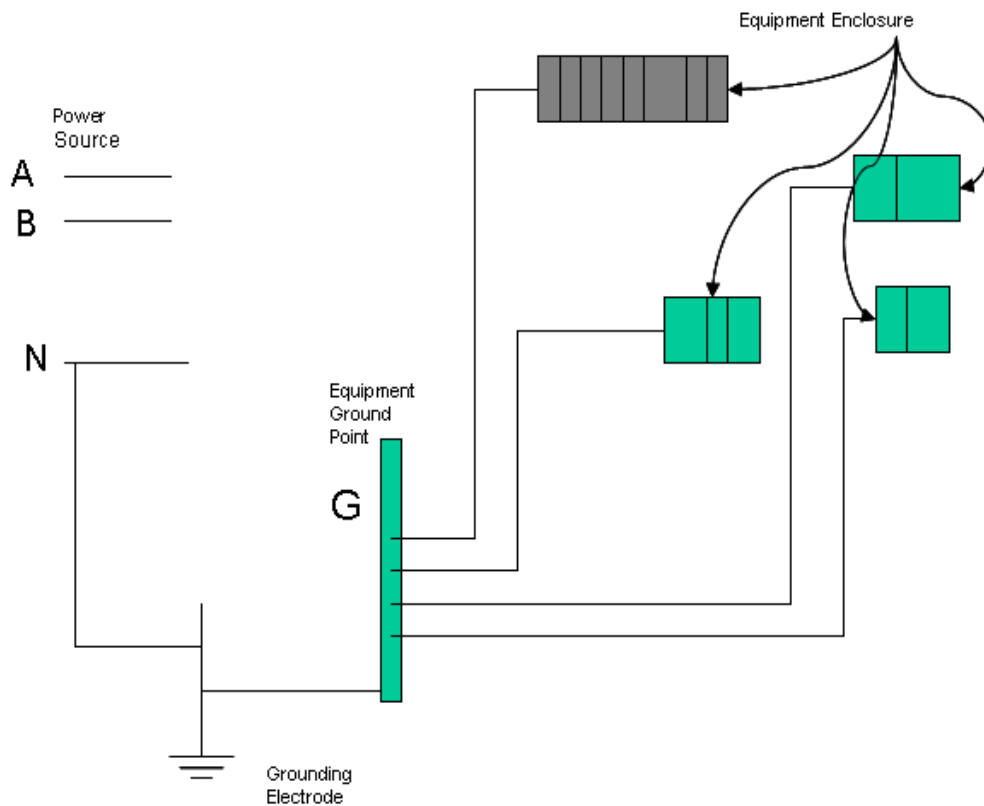
Ground electrical equipment enclosures in accordance with NFPA 70 requirements and to achieve a maximum of 5 ohms to earth resistance. Per the requirement of Art. 645 in the NEC the grounding of communications equipment shall be completed in accordance with Art .250. When grounding communication equipment shall consider proper operation as well as safety from electric shock. Communications equipment shall comply with the NEC and all other safety requirements. Equipment shall be grounded as shown in Figure 9.5.1 and ground loops shall be avoided. Radial grounding shall be implemented. Each piece of equipment shall be fed separately and radially from the source and grounded by means of metallic raceway, a green-wire ground, or any other grounding conductor to a single communication equipment ground point, noted as "G" in the diagram, at the source or distribution point.

NOTE: Cabinets and racks shall be electrically insulated from floor, mounting channels, cabinets, racks, cable trays and the building structures. Each cabinet shall be provided with a ground terminal and connected to a common ground system. Interdependent cabinets and racks may be mechanically and electrically connected to facilitate interconnect wiring.



- a. Each cabinet and rack shall contain a hard drawn copper bus bar, 1 in. by 1/8 in., running the width of the cabinet or rack, having a conductivity of 98 percent of the International Annealed Copper Standard.
- b. Minimum No. 4/0 AWG insulated, soft-drawn, stranded copper wire shall connect the cabinet or rack bus bar to a copper bus bar, which shall be extended over all cabinets and racks in each lineup. This bus bar shall be bare No. 4/0 AWG or equivalent copper bar.
- c. The ground bar for the main distribution frame shall span the length of the frame and shall be a bare No. 4/0 AWG copper wire or a copper bar equivalent.
- d. Cabinet and equipment grounding shall conform to NFPA 70, Section 250, as a minimum.
- e. Cabinet and equipment grounding shall conform to requirements of Single Point Grounded System.

**Figure 9.5.1 Equipment Grounding**



**2. High Performance Ground**

The designer shall be responsible for including a separate high performance communications ground as required for proper and noise free operation of systems. Performance ground shall achieve a maximum of 5 ohms to earth resistance.

#### D. Underplatform Duct Banks

##### 1. General

a. The Underplatform Duct Bank will consist of the following elements:

- 1) Conduits from the guideway cable trough to the Cable Turning Room (CTR). Pulling irons are required in every CTR. One group of conduits comes from each guideway to a common CTR for underground stations. .
- 2) Conduits in the platform from the CTR to both the TC&C room and the CTR at the opposite end of the station.
2. All conduits shall be embedded in concrete duct banks. Two conduits, one from each guideway cable trough to the CTR and then to the TC&C room shall be GRS. All others may be PVC. Spacers are required for PVC duct banks at 6-1/2 feet in longitudinal spacing.
3. Duct banks extending the length of the platform shall be uninterrupted and as straight as possible, bends shall be gradual sweeps (factory sweeps) and shall not exceed 180 degrees of bend, for the entire length of the cable run.
4. Conduits from the guideway cable troughs to the CTR or TC&C rooms shall be uninterrupted and as straight as possible, bends shall be gradual sweeps (factory sweeps) and shall not exceed 180 degrees of bend, for the entire length of this cable run.
5. Exposed cable trays shall include protective metal covers. Use of exposed trays shall be minimized.

#### E. Station Conduit Routing

Subsystem devices of the same system within a station area shall be grouped and routed to an Area-Junction Box. From this Area-Junction Box, all wires of that subsystem will share an adequately sized common conduit for wire routing to the designated Communications Interface Cabinet (CIC).

1. Conduit routing of subsystem devices shall be configured as to reduce the quantities of single conduits runs from devices to a CIC or to the TC&C room.
2. Subsystem Devices located in close proximity to the TC&C room may be grouped and routed directly into the TC&C room. If these conduits enter the TC&C room from overhead, they shall be located 11'-6" above the finished floor or 6" above the room cable tray.
3. Conduit routing shall be configured to provide the routing path with the fewest changes of direction.

## F. Radio Antenna Sleeves and Conduit (For Subway Use)

Radio Antenna Sleeves consist of one and one-half inch (1-1/2") inner diameter nonmetallic sleeves through walls. These sleeves shall be utilized for routing of leaky coax (radio antenna) cables, which are part of the distributed radio antenna system.

1. Sleeves shall be provided through walls, into all rooms or areas accessible to the general public, and LRT and HRT operating or maintenance personnel. Wherever penetrations are made for running Communications conduits shall be sealed properly to make it water proof and fire proof.
2. Sleeves shall be located as far above the finished floor as practical without causing the antenna to interfere with any equipment on either side of the wall.
3. Four (4) two inch (2") GRS conduits from the TC&C room to each trackway shall be provided, total of eight (8) conduits. When the TC&C room is located on other than the platform level, these four conduits shall extend to the outside of the trainway.
4. Two inch (2") sleeves shall be placed vertically from the TC&C room through the ceiling to above grade to accommodate antenna cable for off air interfaces. At least two spare sleeves shall be provided.
5. For those locations requiring off-air repeaters for Radio Services, required size GRS conduit shall be provided between the TC&C Room and each surface antenna location. Routing shall be determined on a site-by-site basis.

## G. Public Address Conduits

## 1. General

- a. Public Address Conduits generally consist of the following:
  - 1) Embedded conduit from the TC&C room to the speaker zone with interruptions at speaker backboxes or junction boxes.
  - 2) An embedded return conduit from the last speaker in a "string" to the TC&C room.
  - 3) Conduits in ancillary areas may be surface mount and shall have a two-hour fire rating.
2. All conduits shall be GRS. No other circuits may be shared in a PA conduit. All PA conduits shall originate and terminate in the TC&C room. Minimum size is one inch (1").
3. Two separate one-inch conduits run directly from a backbox (8" x 8") or junction box at the approximate midpoint of the mezzanine ceiling and the midpoint of the platform ceiling to the TC&C room.

#### H. Closed Circuit Television Conduits

Conduits for the Closed Circuits Television system consist of two conduits in parallel, both serving each camera location. Maximum six camera locations may be served by one conduit run. All conduits shall be GRS, minimum one inch (1"). Conduits shall be routed directly from the junction boxes to the TC&C room. No other circuits may be shared in a CCTV conduit.

#### I. Fire and Emergency Management Conduits

Fire and Emergency Management Conduits shall be embedded GRS conduit for various types of detectors, sound powered telephones and emergency annunciation cabinets/panels.

1. Embedded or concealed GRS conduits shall be provided from all fire system detector junction boxes to the appropriate CIC or to the TC&C room. Conduits shall be a minimum of one inch (1"). No other types of circuits may be shared in a fire system conduit.
2. Junction boxes for detectors shall be embedded and located nine feet above finished floor in a wall. (The Systems Contractor will extend the circuit via surface mounted conduit to the ultimate detector location).
3. The Emergency Management Panel (EMP) shall be provided with four (4) three inch (3") conduit and two (2) one inch (1") which shall run directly from the EMP to the TC&C room.
4. The Auxiliary EMP (Subway System only) shall be provided with two (2) two inch (2") conduits which shall run directly from the CP to the TC&C room.

#### 9.5.3 Tunnel Conduit/Tray Routing

Subsystem devices of the same system within tunnel area shall be grouped and routed to an Area-Junction Box. From this Area-Junction Box, all wires of that subsystem will share an adequately sized common conduit or tray, for wire routing to the designated Communications Interface Cabinet (CIC).

1. Conduit or tray routing of subsystem devices shall be configured as to reduce the quantities of single conduits or tray runs from devices to a Communications Interface Cabinet (CIC) or to the station or tunnel area TC&C room. The designer shall submit tray loading calculations (CDRL).
2. Subsystem devices located in close proximity to the station or tunnel TC&C room may be grouped and routed directly into the TC&C room. If these conduits enter the TC&C room from overhead, they shall be located 11'-6" above the finished floor or 6" above the room cable tray.
3. Conduit or tray routing shall be configured to provide the routing path with the fewest changes of direction.
4. Subsystem devices, conduits, trays, distributed antenna cables and other fire/live safety communication installations CANNOT be mounted in the proximity or the train dynamic

envelope and passenger emergency egress, such as safety walks and emergency exits. For example, subsystem devices, conduits, trays, distributed antenna cables and other fire/live safety communication installations cannot be mounted anywhere directly above the LRV pantograph.

5. Subsystem devices, conduits, trays, distributed antenna cables and other fire/live safety communication installations shall be not conflict with other tunnel installations and shall not come closer than 6 inches to the vehicle dynamic outline at any point in the tunnels.

#### **9.5.4 Communications Power System**

All stationery systems equipment shall be powered from stationary battery/rectifier or UPS plants, as applicable.

##### **A. Batteries**

Batteries in TC&C (C&S), yards and ROC battery rooms shall be gel sealed batteries, non-outgassing storage type of long-duration/low-rate. .

##### **B. Rectifiers**

Rectifiers shall be dual and load-sharing, with each rectifier capable of supplying full equipment load while recharging a fully discharged battery.

##### **C. Battery Racks**

Battery racks shall be not larger than two-tier configuration, and shall be constructed with seismic bracing in accordance with the UBC Requirement for Seismic Zone Four.

##### **D. Voltages**

Battery/rectifier plant voltages shall be as follows:

Battery voltages for communications equipment shall be compatible with the equipment requirements.

##### **E. Sizing**

Battery sizing shall provide full load for a minimum 4 hours of main AC power outage.

##### **F. Recharge Time**

The recharge time of a battery plant shall not be greater than four times the discharge time period, e.g., discharge 4 hours, recharge 16 hours.

Refer to Electrical Section 7.10.3 for Uninterruptible Power Supply (UPS) design requirements.

## **9.6 RADIO SYSTEM**

### **9.6.1 General**

1. The radio system shall provide the primary medium for voice transmission between the ROC, Yard\*, maintenance facilities, wayside and rail line passenger vehicles along the alignments.  
 \* The Yard and Maintenance Facilities channel is for train yards use and is not required at stations. The train mobile radio, however, shall be capable of operating on the yard frequency.
2. The radio system shall also provide facilities to support emergency response, e.g., fire, law enforcement agency, police agency, or security, etc., for all sections of each rail system.
3. The radio system for Metro Operation and Maintenance shall be an extension of Metro currently operational ICOM's IDAS' digital radio system using ICOM IP Voice & Control Protocol (Conventional Mode) over Ethernet and the NXDN (Next Generation Digital Network) common air interface. The NXDN protocol uses frequency division multiple access (FDMA) and 6.25 KHz very narrowband channels.
4. The radio system for Metro Transit Police shall be an extension of currently used analog narrow band (12.5 KHz) 450/460 MHz radio system.
5. The radio system shall support subscriber vote scanning to optimize radio service connections. Repeater system based receive voting and multi-cast transmitting shall be used to optimize uplink and downlink signal communications across the strongest signal available.
6. All radio system and supplementary equipment shall be compliant with TASC monitoring system including alarm monitoring and event notification for message status and alerts to the ROC.

**7 Radio Coverage**

Radio coverage shall be based on talk-back originating from portable and vehicle radios in the underground sections and along the at-grade and aerial above-ground sections of the rail systems. For the purpose of coverage calculation, the underground and above-ground sections shall be considered separately. Talk-back coverage from rail vehicles and talk-out coverage to portable and rail vehicle radios shall be not less than talk-back coverage from portable radios. An RF signal coverage test shall be conducted to demonstrate that the radio system meets the requirements.

**8. System Assurance Program**

For the Radio System Equipment, the following required Reliability (minimum MTBF) and Maintainability (maximum MTTR) values in hours are established per each typical unit equipment set:

a. Base Station Radio Assembly	MTBF (HRS) – 25,000 MTTR (HRS) – 1.0
b. Channelized Repeater Amplifiers    Assembly	MTBF (HRS) – 25,000 MTTR (HRS) – 1.0

All system, sub-systems, components, and parts shall be designed such that no

single failure shall cause an unsafe condition. This requirement shall apply for all phases of the design, including in-service support, warranty, retrofit, and field modifications.

The designer shall establish and maintain an effective reliability program throughout the design, manufacturing, installation, testing, and operations activity.

### 9.6.2 *Underground and Tunnel Radio Systems*

#### A. General

1. The radio subsystem shall encompass the ROC, wayside, passenger station, passenger vehicle, Yard, mobile and portable equipment. The radio subsystem shall provide two-way radio communications over channels in the 160 MHz band for Rail Operations and Maintenance, and channels in the 450/460 MHz band for Transit Police. When underground facilities are located within City of Los Angeles jurisdiction, channels shall be provided in the 460/500 MHz band for the Los Angeles Police Department (LAPD), Los Angeles County Sheriff Department (LASD) and Mutual Aid Channel(s), and in the 800 MHz band for the Los Angeles City Fire Department (LAFD). When underground facilities are located outside City of Los Angeles jurisdiction, channels shall be assigned and provided as required by local jurisdiction. Note that channels from local jurisdiction could be expanded into the City of Los Angeles or vice versa.

Limited radio channels shall be permitted (no more than 23 channels) to enter the underground stations and tunnel area to reduce the possible intermodulation generation. Intermodulation studies for frequencies are to be included in the radio system design.

Within segments of the radio system, each identical function shall be performed by interchangeable units. In no case shall the equipment or hardware used in one portion of the radio system be different from that used in another portion to perform the same function under identical operating and environmental conditions. Design of equipment performing like functions shall be standardized.

#### 2. Equipment Accessibility

- a. The design shall insure the proper size of self retaining fasteners for cable and surface wiring. Latch hold open devices shall be provided when applicable. The shelf and cabinet mounted equipment shall be easily accessible by maintenance personnel.
- b. Human factors insuring changeability and accessibility shall be provided in accordance with MIL-STD-1472.

#### 3. Equipment Arrangement

Normal testing shall not require disassembly of the equipment under test or of any other equipment.

Equipment arranged in cabinets shall be designed for air cooling, such that no modules/assemblies shall operate with surface temperatures in excess of manufacturers' recommendations or 110 degrees F, whichever is lower. Fans or air condition units shall be provided in cabinets where necessary to meet this requirement.



#### 4. Wiring

Wires distributing AC and DC power shall be continuous from the power distribution point to the equipment power input terminals. Power feeds to equipment cabinets shall be in conduits.

Terminations and associated identifications shall be installed permanently to maintain their original positions. Terminations shall be sealed to prevent moisture penetration into cables.

Where necessary, cables shall be supported or secured to prevent the transfer of damaging mechanical stresses to terminations, equipment or structure.

#### 5. System Configuration:

- a. Frequency Allocation: The radio system equipment design and configuration shall be such that any present or potential transmitter intermodulation will not cause interference on other radio channels in the system. During different design stages and during testing a detail description of design measures and equipment shall show the mitigation of harmful intermodulation product frequencies from causing radio interference.

An RF signal intermodulation test shall be conducted to demonstrate that the radio system meets the requirements stated above.

- b. Radio System Operation: All underground Metro channels and Transit Police Channels shall be operated from base station repeaters linked back to and controlled by equipment in the ROC. The system shall employ built-in voting function, so an external voter device is not required. In that the voting equipment at ROC will select the signal from the base station receiving the strongest transmission from portable, or train radio and retransmit this signal over all base stations in the underground portion of the system. The operators at ROC transmit over all base stations when they wish to make transmission. Mobile/portable radio shall provide multicast voting function for downlink communications.
- c. Equipment Compatibility: The equipment to be installed in all segments must be operationally compatible with the equipment Metro installed. It should be noted that the existing equipment may not interface with another manufacturer's equipment.
- d. Underground Antenna System Configuration: The underground antenna system shall consist of distributed antennas, radiating coaxial cables or combination of technologies designed to meet the performance level for the environment in which they will be utilized. Dual antenna system, one for receiving, one for transmitting shall be used to extend reception and transmission of radio signals in the underground areas. The selection of antenna technologies shall be part of the intermodulation, power budget, coverage and architectural design. The radio system shall be design to meet the coverage requirements. Low profile free space antennas are preferred in stations passenger areas where aesthetic considerations and/or design criteria warrant their use. If radiating coaxial cables are used in passenger areas, they shall be concealed by a cover. The cover shall match the color of the wall or have a decorative stripe. Signal loss caused by these covers, if used, shall be considered in the power budget computations. Radiating

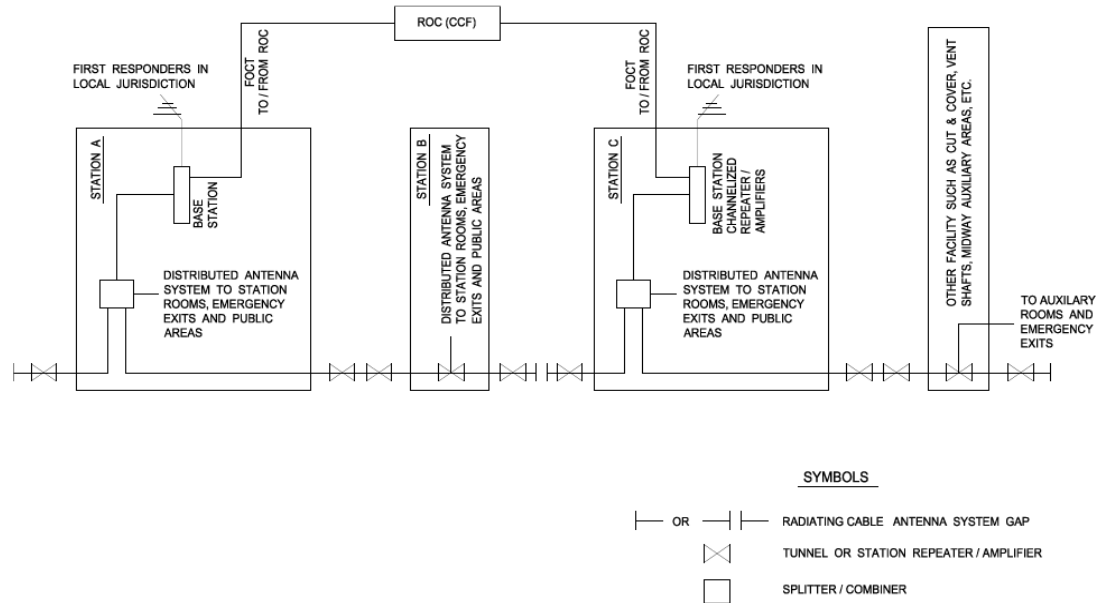


coaxial cables shall be used throughout the train tunnels. Wherever the antenna system design calls for active devices such as amplifiers, within the tunnels, these devices shall be installed in tunnel cross passages or other areas that during maintenance will not cause train movement interruption. The tunnel radiating cables shall have RF attenuation characteristics such that the tunnel amplifier gains can be limited to 30 dB or less.

High quality active devices (amplifiers, etc.) and passive devices/components (splitter, couplers, connectors, etc.) shall be provided throughout to insure intermodulation products are minimized. At no point in the antenna system shall the ratio of overall desired signal carrier to undesired intermodulation products be less than  $43+10\log P_c$  ( $P_c$ =Watts Carrier). It is recognized that use of lower loss cables may affect the quantity, types and/or spacing of signal booster devices (amplifiers) required to meet the performance specifications of radio coverage and intermodulation products in the tunnels. A continuous cable route, with a minimum number of splitters/dividers is preferred. If the antenna cables must be split to cover a specific area, the splitters shall be installed above the false ceiling, or where there is no false ceiling, concealed by a suitable aesthetic cover. The antenna system shall not have physical and electrical characteristics altered by exposure to ambient conditions. Cable splices/connections shall be made only with suitable connectors that ensure a sound mechanical and electrical connection. Connectors with precious metal (gold) center pin conductors shall be used to ensure low loss at connections. Connector shells shall be stainless steel or other non-ferrous material. The cables shall be supported by noncorrosive supports at designated support points. The base station receive antenna cable shall be on the tunnel side wall mounted to unistruts / anchors. At the end of each transmitting antenna cable span, the cable shall be routed down the side wall of the tunnel to a point approximate five (5) feet above the walkway level. A cable termination device and sampling port shall be installed at this point. Free space antennas may be used in lieu of radiating coaxial cable to provide communications within passenger stations. This is to include the platform, mezzanine, corridors, fire exits, and other areas of the passenger station. The antenna(s) must be capable of transmitting and receiving 160 MHz, 450/500 MHz and 800 MHz frequency bands for Maintenance Personnel, Operations, Transit Police, LASD, LAPD, Mutual Aid Channel(s), LAFD (or other first responders in local jurisdiction) services, and others as required by the specific Project. Free space antennas that replace the radiating cable shall be concealed by aesthetically pleasing covers. The covers shall have minimum RF signal loss. Any cover loss shall be considered in the power budget computations. The underground ground radio system block diagram is shown in Figure 9.6.1.

All radiating and coaxial cables are plenum rated, with low smoke, low fume, non-halogen producing outer jackets. Radiating cables in tunnels are supported on standoffs, which support the cables approximately 3 inches from the tunnel walls. Standoffs are installed five feet on center intervals apart along the entire length of the tunnels. Anchors and fastener are provided in tunnel walls, station walls/ceilings and other areas as required for mounting antenna cables and associated radio antenna hardware. Anchors, fastener, mounting studs and other mounting hardware shall use stainless steel or high temperature heat resistant material (to be approved by Metro).

Figure 9.6.1 Underground Radio System Block Diagram



6. Coverage requirements:

- a. The voice signal quality shall be not less than CM-4 with a coverage requirement of 100% probability of communications along 100% of the tunnel, emergency exits and public areas locations. The radio signal quality shall be 18 dB SINAD or better.
- b. The voice signal quality shall be not less than CM-4 with a 95% coverage probability at 95% of auxiliary locations such as equipment rooms. The radio signal quality shall be 18 dB SINAD or better.
- c. This 95% requirement cannot be met by averaging coverage over the system; i.e., one station with 90% and the next with 100%. Each station or area of the station shall stand alone as an entity.
- d. RF Power Budget

The design shall be based on power budget computations based on the equipment and final design being proposed.

The RF power budget shall be analyzed for the frequencies bands. All computations are outbound from the base station location to a portable or mobile radio unit in the tunnel. RF amplifier requirements shall be determined from the power budget analysis.

Templates for power budget calculations are provided in Appendix C at the end of this section. Parameters shown in template are minimum required parameters to be used in power budget analysis.

An RF signal coverage test, shall be conducted to demonstrate that the radio system meets the requirements stated above.

- e. Test Transmitters

Sets of Test Transmitters, compatible with remote control equipment installed at the first responder authority's dispatch center and center control desk shall be part of the radio system.

- f. Maximum test points shall include the location at 100 feet distance at any evacuation or maintenance walking surface area and in the train.
- g. The Contractor's design shall be such that the minimum margin calculations shown in the power budget template provided in Appendix C shall not be less than 10 dB throughout of the entire system.

#### B. Functional Requirements

1. The radio system for operations and maintenance shall operate on six (6) 160 MHZ triplex radio channels where there are two (2) different downlink radio channels with one (1) uplink radio channel per associated triplex radio channel. Also, three (3) 450/460 MHZ duplex voice analog channels with narrow band 12.5 KHz shall be provided for transit police security.

Radio transmitting and receiving equipment shall be provided at all passenger stations where required, and in crosspassages between stations if necessary.

Base station radios shall provide services for the Operation and Maintenance of the transit system, and Transit Police channels.

The base station sites for LAPD and LAFD or other first responders in local jurisdiction shall be based on the Channelized Repeater Amplifiers (CRA).

2. Radio communications between mobile and portable radios shall be possible through base stations. Below ground communications shall be via a distributed antenna system (radiating cables/free space antennas). Base station transmissions shall be broadcasted simultaneously at all base station locations to enable users on the voice channels throughout the system to hear all control center, train, and portable radio transmissions on their respective channels. The system shall be designed so that a signal launched into the underground antenna system at any base station location, shall be propagated to the ends of its respective antenna (antenna system gaps) within 50 microseconds after being launched. The 50 microsecond interval shall include delays imposed on the signal through Channelized Repeater Amplifiers (CRAs)/amplifiers en route.

The above ground antennas shall be installed at a height to provide the required signal propagation and reduce any possibility of vandalism. Those antennas shall provide signal strength to ensure reception of radio signal from distant transmitters and receivers to achieve the required coverage requirements. In addition, the antennas must be covered with an aesthetic covering that fits into the décor of the station.

Base stations and CRAs shall be solid state devices rated for full continuous duty and shall meet or exceed the requirements of all applicable EIA and FCC standards. The base stations and CRAs will include, but not be limited to, transmitters, receivers, power supplies, control circuitry, service and maintenance test panels, and intercom modules.

Base stations, CRAs, and associated equipment at the TC&C room, and other

locations that require environmental control, shall be mounted in suitable enclosed cabinets. The base stations shall include meters for monitoring transmitter and receiver performance. Meters and the associated function switches shall be contained within the equipment cabinet.

Separate, self-contained base station shall be installed for the Metro Rail Operation and Maintenance, and Transit Police channels. Table 9.6.1 and 9.6.2 below shows minimum technical requirements for repeaters. Table 9.6.3 shows minimum technical requirements for CRAs.

**Table 9.6.1 Repeater Radio Specifications for 160 MHz Frequency Band**

<b>Parameter</b>	<b>160-161 MHz</b>
Antenna Impedance	50 Ohms
Number of channels	Max. 32 channels
Channel Spacing	6.25 KHZ
Transmitter output power	As required to meet coverage specifications
Transmitter Frequency Stability	±0.5 PPM
Transmitter Spurious and Harmonic Emissions	80 dB typ.
Transmitter Intermodulation Attenuation	50 dB
Max Frequency Deviation	±5 KHz/2.5KHz(wide/narrow)
FM hum and noise	50/45 dB (wide/narrow)
Audio Harmonic Distortion	1% (40% deviation)
Oscillator Frequency Stability	±0.0002% (-30 to +60°C)
Receiver Sensitivity (analog) 12 dB SINAD	17 dBm typ. (0.30 µv typ.)
Receiver Sensitivity (5% BER)	19 dBm typ. (0.25 µv typ.)
Adjacent Channel Rejection (digital)	63 dB typ.
Intermodulation Rejection (EIA SINAD)	75 dB typ.
Spurious and Image Rejection	90 dB typ.

**Table 9.6.2 Repeater Radio Specifications for 450/460 MHz Frequency Band**

<b>Parameter</b>	<b>450-465 MHz</b>
Antenna Impedance	50 Ohms
Transmitter output power	As required to meet coverage specifications
Transmitter Frequency Stability	Derived from common source
Transmitter Spurious and Harmonic Emissions	85 dB below carrier
Transmitter Modulation Deviation	±5 KHz
Audio Distortion	<2% at 1,000 Hz
Receiver Channel Spacing	12.5 KHz
Oscillator Frequency Stability	±0.0002% (-30 to +60°C)
Receiver Sensitivity (EIA SINAD)	0.35 µv
Receiver Selectivity (EIA SINAD)	-90 dB
Intermodulation (EIA SINAD)	-80 dB
Spurious and Image Rejection	-100 dB

**Table 9.6.3 Channelized Repeater Amplifier Specifications**

<b>Parameter</b>	<b>460-512 MHz</b>	<b>808-862 MHz</b>
Transmitter Channel Spacing	12.5 KHz/6.25 KHz	
RF frequency stability	Tracks input signal exactly	
Adjacent channel selectivity	60dB (minimum)	
RF output power, max.	5 W	5 W
Output power adjustment range	+0 to -10 dB	
Variation of output power with input level	+0 to -1 dB	
Input dynamic range	-90 to -20 dBm	
Input trigger level adjustment range	-90 to -40 dBm	
Duty cycle	Continuous	
RF spurious output	-60 dBc (maximum)	
Input/output impedance	50 ohms	
Primary power	115 VAC + 10%	
Power consumption max.	20 watts, nominal	
Mounting information	Standard 19 inch EIA rack-mountable	

The Channelized Repeater Amplifiers (CRAs) provided for interfacing and repeating LAPD, LAFD, or other local jurisdiction's radio service underground shall employ hi-gain antennas (one for 460/500 MHz and one for 800 MHz). The design for these services shall be based on receiving on off-air signal strengths

of -50 to -89 dBm at the antennas locations.

The CRAs shall be equipped for remote ON-OFF Control via the TRACS system.

Return path transmissions from LAPD/LAFD (or other first responders in local jurisdiction) portable radios in underground stations/tunnels shall be transmitted via the underground antenna system CRAs for subsequent retransmitting via above ground antennas. These CRA and antenna gains should be set so that the effective radiated power shall be approximately +37 dBm for LAPD channels, +34.8 dBm for LAFD channels.

Narrow band RF unidirectional amplifiers shall be used in the tunnels and stations as required to meet the coverage requirements.

Crossband couplers/filters shall be required at the amplifier locations. The indicated crosspassages will have AC power to power amplifiers (or CRAs, where used in lieu of amplifiers). Four hours backup battery power supplies and charges for the amplifiers/CRAs shall be part of the system.

The Base Stations, CRA and the amplifiers shall have summary alarms to indicate a failure. The summary alarm shall be routed to the TRACS system for reporting to the ROC.

Parameters to be monitored and controlled include:

- An alarm for the transmit and receive voice audio lines for each radio base station.
  - A summary alarm for each LAPD and each LAFD off-air repeater or other first responders in local jurisdiction.
  - An alarm for each RF amplifier.
  - Crosspassage backup power system alarms.
  - CRA ON-OFF Controls.
3. All radio equipment supplied shall be the 160 MHz very narrow band (6.25 KHz) for Metro Operation and Maintenance, and 450/460 MHz analog narrow band (12.5 KHz) for Metro Transit Police radio system.
- a. Mainline Operations  
Six (6) triplex channels (Talk-out) shall provide the normal operations radio links for the wayside.
  - b. Transit Police  
Three (3) duplex analog channels with narrow band 12.5 KHz (Talk-out) shall provide the transit police radio links for the wayside.
  - c. Channel control shall be provided in the Train Dispatch, Communications, and Supervisors Consoles. All personal portable radio and mobile radio units shall be equipped to communicate over these channels.
4. All radio equipment shall support following calling features in digital conventional mode operationally and functionally compatible with Metro's existing very narrow band (6.25 KHz) Digital Rail Radio System that operates in the 160 MHz frequency band.

a. Selective call, group call and talk group ID

The radio system shall allow to call individual or group users. The radios shall automatically send their own ID number when the PTT button is held down. The radios shall memorize minimum 500 of both individual/group ID numbers and alias names in the table. The alias name or individual/group ID is displayed on the LCD while receiving a message allowing user to identify who is calling.

b. Talk back function and call mode selection

When the talk back function is enabled, the radio shall automatically select the received talking group or individual ID to reply to the received call, while the talk back timer remains. After the talk back timer is exceeded, the radios shall set to an initial call mode depending on programming which is either talking group or individual call or retain the previous user call mode selection.

c. Digital voice scrambler

When secure communication is required, the radio system shall provide a digital voice scrambler using a 15-bit key (about 32,000 codes) as standard. This shall be added security to the digital modulation/demodulation.

d. Emergency call functions

When the emergency button is pushed an emergency signal shall be automatically sent to the dispatcher or another radio. Other emergency features are a man down feature and a lone worker function. A remote radio monitor function shall allow the dispatcher to turn on the PTT button from a remote location and transmit anything the microphone hears for a preprogrammed time period.

e. Status message

The radio system shall allow a set up to 100 conditions such as "on duty", "at lunch" or "in route". This message shall be sent each time the PTT button is pushed until the status message feature is turned off. Also, the user shall be able to request another unit to send their status and receive it.

f. GPS position reporting

When the radio is used with built-in GPS capability for the handheld radio or an external, third-party GPS for the mobile radio, the user shall be able to transmit current position information to another radio or the dispatch. Three different sending intervals can be programmable: on PTT; when polled; or at periodic times. When connected to a PC that has mapping software installed, the dispatch shall know the activity of the fleet members (when radio last sent position or when it was polled).

g. Radio shut off, stun and revive

The radio shut off function disables a lost or stolen radio over the air, eliminating security threats from undesired listeners. When the radio stun command is received, all functions shall be temporary locked out until the



revive command is received or the user password is entered. The radio shall also send radio stun, kill and revive commands.

h. RAN (Radio Access Number) for digital code squelch

The RAN (Radio Access Number) code is the digital equivalent of CTCSS for accessing a radio repeater or digital squelch function.

i. Short Data Message capability

Radio shall be able to send and receive short data messages of up to 12 characters between the radios or from the remote communicator.

j. Other features

- Radio check function shall allow to verify if another radio is within communication range
- Call log displays the received call history
- Call alert function notifies receiving party that a call is coming with a beep sound and blinking icon
- Base station operation for repeater
- Late entry: the radio shall decode the received ID and show group ID, unit ID or alias name on the display even when turned on during a conversation.

5. IDAS Multi-Site Conventional (Voting) for Metro Operation & Maintenance Radio System

IDAS Multi-Site Convention Blue (Voting) is a method of providing single group wide area coverage with a focus on optimal subscriber reception by the system. Combined with subscriber "Vote Scan" IDAS Blue can be a complete replacement for legacy simulcast system. It offers seamless coverage and no need for the subscriber equipment operator to "change channels" regardless of location.

IDAS Blue can be offered with essentially unlimited number of system receivers and more system transmitters.

In either configuration, when initiating a call, the subscriber unit will transmit on the common RX frequency, shared by all the receive sites on the network. One or many of the sites may receive this transmission. These receive signals are transported, via the IP network as packets, to the IDAS voting comparator (which is a standard FR5000 configured as a voting unit). This card determines the best received signal via the RSSI information contained in the IDAS packets.

The packet with the best RSSI figure is then routed to multiple site transmitters for Multi-Cast transmission. Where there are multiple site transmitters, the operator of the subscriber units need not change channels to select the optimal transmitter for his area. In this case, "Vote Scan" is activated on the subscriber unit in addition to "beaconing" on the system side of things.

Functionally, the "Vote Scan" and "beaconing" systems work together. Periodically, the IDAS site transmitters generate a beacon pulse. These pulses are received by the subscriber units and are analyzed for the strongest RSSI.



The subscriber unit then listens for traffic from the site that has generated the strongest beacon pulse as received. Thus the subscriber radio is always monitoring the strongest available site for traffic. The subscriber units are always monitoring the transmitters, and will automatically change to the strongest site. No channel changing is required by the user.

A full suite of console services and a complete integrated solution to radio system shall be provided by Avtec.

## 6. Performance Criteria

### a. Radio Equipment (General)

Radio base stations shall be located as needed to provide coverage. Fiber Optic transmitters, where used, shall be at the ROC, and shall have a capacity to accommodate all radio receiving equipment, and shall be of the type that gives priority to the receiver on each channel having the audio signal with the best signal-to-noise ratio. The transmitters shall be such that once an initial receiver selection has been made, continuous voting shall take place such that the best quality signal shall always be presented to the radio operator at the console. The apparatus shall also be capable of locking onto the initially selected receiver throughout the transmission.

- b. The service shall be designed such that the stated grade of service prevails over the entire mainline area.
- c. All radio equipment to be installed in locations having environmental control shall be mounted in relay-type equipment racks. Equipment to be installed in locations with hostile environments shall be mounted in suitable weatherproof cabinets (NEMA 4 type enclosures).
- d. All radio repeater equipment shall be linked to the ROC for the remote control and supervision of transmit and receive functions.
- e. Transmitter frequency shall be of sufficient stability to support the subsystem requirements herein and to prevent the appearance of extraneous audio tones. All combinations of base stations shall be capable of concurrent operation without harmful interference between any channels (intermodulation).
- f. Radio repeaters shall be rated for continuous duty and shall be capable of continuous transmit operation.
- g. Radio equipment shall be furnished with indicator and alarm circuits for:
  - 1) Base station Function disable
  - 2) Low or no RF power with "transmitter turn on"
  - 3) Base station failure
  - 4) Loss of AC power
  - 5) Loss of DC power

- h. Base stations shall be furnished with transmitter power monitor and alarm circuit. Reduced power output shall alarm at ROC via SCADA.
- i. Each radio equipment installation at a station shall be powered from Un-interruptible Power Supplies (UPS) or floating battery systems.
- j. Class B Booster Amplifiers shall not be used for surface transmissions. Rather, the usage of Class A Booster Amplifiers, per the Federal Communications Commission CFR 47 part 90.219, shall be used for all surface/above ground transmissions.
- k. All components making up the RF communications shall be FCC type accepted for its manufacturer intended usage.
- l. Due to the operational characteristics of the existing Metro Radio system, there shall be two (2) downlink channels per one (1) uplink channels as each of the two (2) downlink channels are installed in alternative transmit zones. Stated in alternative means, there are two duplex channels with two different downlink channels and the same uplink channel i.e. a triplex channel.

#### 7. Mobiles and Portables Equipment

Mobiles shall be provided in operator cab of each passenger vehicle dependent pair. Mobiles and Portables shall comply with the following criteria:

- a. Use synthesized frequency-determining circuits to provide stable oscillator frequencies for both the transmitter and the receiver.
- b. Power for the mobiles shall be furnished from the passenger vehicle low-voltage power supply. Vehicle-generated electrical noise shall be mitigated by filtering and other EMI preventive methods and shall not affect radio subsystem operation.
- c. Mobiles shall be controllable from the energized operation cab by a remote control unit that will be installed in each operator cab.
- d. Shall be equipped with RAN (Radio Access Number) code for accessing a radio repeater or digital squelch function.
- e. Provide a POWER ON indication to the remote control unit.
- f. Mobiles provide an audio output for use with a separate speaker in the operator cab.
- g. Mobile and Portable VHF radios shall be functionally and operational compatible with the ICOM IDAS mode at 6.25 KHz digital modulation. Vote-Scan shall also be provided on the Mobile and Portable radios.

#### 8. Antennas

- a. The repeater antennas and transmission lines shall conform to applicable EIA Standard RS-329 and shall be designed to meet the performance levels for

the environment in which they will be utilized. Lightning protection shall be provided on antennas, where applicable.

- b. Distributed antenna shall:
  - 1) Be the primary radiating and receiving element in tunnels, subway passenger stations, and ancillary rooms. Supplemental space antennas may be used in these areas to provide additional coverage where necessary.
  - 2) Not have physical and electrical characteristics altered by exposure to ambient conditions.
  - 3) Be spliced only with connectors that ensure a sound mechanical and electrical connection.
  - 4) Be capable of passing UL 83 flame resistance tests (outer jacket).
- c. Supplementary below-ground antennas shall be suited to the frequency bands indicated and be appropriate for the specific site and usage. The antennas shall have the gain, bandwidth, and pattern required to provide the specified grade of service.
- d. At Grade Antennas for Off Air Use
  - 1) Low profile panel antenna type.
  - 2) The antennas shall be single band rated at the required 450/500 MHz and at 806-896 MHz band.
  - 3) The antennas shall be of a high gain type (12 to 15 dBi).
  - 4) Technical specification of antennas shall be submitted to Metro for approval.

9. Radio Recorder/Playback Unit:

A dedicated computer with specialized application software shall be used for the radio channels and talk group telephone lines audio recording and the instant recall/playback of all recorded activities.

10. Electromagnetic Compatibility Control Program

- a. An electromagnetic compatibility (EMC) Control Plan shall be implemented throughout the design to ensure that the Radio System will operate in its intended electromagnetic environment without earlier causing or suffering unacceptable interference due to electromagnetic emission or response. The Control Plan objective is to provide equipment and installation parameters that will assure an electromagnetically compatible system.
- b. The implementation of EMC shall include control of conductivity coupled interference, interference coupled through common impedances, and interference coupled through radiated electric and magnetic fields.
- c. Analysis:

The plan shall identify the techniques to be employed for ensuring the adequacy of specific aspects of the mechanical, electrical, and electronic

design, including electromagnetic radiation. Identify equipment for which existing analyses and data document EMC in identical or similar applications. Identify any potential issue areas, and outline appropriate measures to be implemented to control EMI. Shield circuit wires and twisted pairs in cables shall be to minimize electrostatic and electromagnetic coupling.

Consideration shall be made to the electromagnetic environment to which the wayside and vehicle-borne Communications System equipment will be exposed and special techniques to eliminate interference with operation of this equipment.

Consideration shall be made to the RF environment where amplifiers and CRA's are exposed. Unitization of double shielded/rigid coaxial lines to couple input/output ports and ancillary devices such as couplers, splitters, etc. to prevent self oscillation.

Power levels in wires within a common bundle or harness shall not exceed a 30 dB spread.

Shields must be electrically continuous and grounded at one end only.

### 9.6.3 Above Ground Radio System

#### A. Communication System Description

The Radio Communications System for the above ground coverage shall use two-way radio communications in the 160 MHz Frequency Band for Rail Operations and Maintenance, and the 450/460 MHz Frequency Band for Transit Police. The above ground Radio System consists of several elements as the following

##### 1. The Radio System

The voice radio system consists of a multi-site, multi-channel 160 MHz band utilizing ICOM NXDN protocol and very narrow band 6.25 KHz radio channels for Metro Operation and Maintenance.

And Metro Transit Police radio system utilizing 450/460 MHz bands with analog narrow band 12.5 KHz radio channels.

At grade and aerial coverage shall be 100% with no exceptions and include the area extending not less than 500 feet each side of the right-of-way, the main and satellite yard, and the Central Control Facility external areas.

##### 2. Dispatch Console Equipment

Radio control equipment shall be provided for light rail line Transit Operations Supervisor (TOS), communication controller and ROC supervisor console positions. The equipment shall be capable of monitoring and accessing all of the talk groups in the system.

##### 3. Mobile, Portable, Control Station and Repeater Station Equipment

a. Mobile, portable and control station equipment shall be provided to operate as part of the 160 MHz radio system. The mobile radios shall be two-piece construction, with a RF control head connected by a cable to the transceiver unit. The RF control head shall contain the usual functions such as speaker volume, talk group select, talk group display, power, MDC-1200 ANI features and transmit indicators. In addition, trainborne mobile radios shall be equipped with train interface connections for input audio, output audio, PTT leads and emergency trigger. Finally, all mobile, portable, and control station radios shall operate with the ICOM NXDN protocol at 6.25 KHz with Vote-Scan enabled.

b. Each portable radio shall have a connector for a speaker-microphone.

c. Control stations will be used at specified yard, ROC and office facilities and commercial power mains. ROC based control stations shall be connected to the ROC's UPS.

d. Radio equipment shall be furnished with indicator and alarm circuits for:

- 1) Repeater Function disable
- 2) Low or no RF power with "transmitter turn on"
- 3) Repeater failure
- 4) Loss of power

- e. Repeater stations shall be furnished with transmitter power monitor and alarm circuit. Reduced power output shall alarm at ROC via SCADA.
- f. Each radio equipment installation at a station shall be connected to back-up power such that operation is possible in event of a commercial power outage.

4. Backhaul communications

Each remote base station will require wide area network connectivity to the ROC through the either the fiber optical or microwave radio communications backbone.

5. Emergency Trigger Alarm

- a. Each portable radio shall be equipped with an emergency button. Once the emergency button, hereafter designated the Emergency Trigger, is depressed, the system shall automatically assign the highest priority to that portable.
- b. Mobile radios installed in light rail passenger vehicles shall include a means for external, remote activation of the Emergency Trigger. For mobile units installed in the existing MBL passenger rail vehicles, connection shall be as directed by Metro.
- c. Mobile radios installed in maintenance, highway and high rail vehicles shall have an emergency trigger in a readily accessible location but protected from accidental activation.
- d. At the System Communications Controller Console in the ROC the emergency condition shall be audibly and visually annunciated. The System Communications Controller Console and both systems control terminals shall be able to reset an emergency alarm.

6. Automatic Base Station Identification

Automatic International Morse Code station identification shall be provided for the radio system. Operation of the automatic station ID shall be in accordance with FCC Rules and Regulations 90.647(b) for radio systems.

7. Adding Additional Sites to the System

In accordance with FCC licensing, the Authority as assigned sites within the Los Angeles basin for the 160 MHz radio system. As light rail lines expand there may be a possibility that additional sites, both above and below ground, may be required for proper coverage. The following criteria apply to adding sites to the system.

Any site equipment added to this system shall be one hundred percent (100%) compatible with the existing system.

## 9.7 TELEPHONE SUBSYSTEM

### 9.7.1 General

- A. An IP Telephony System with an interface to the existing Metro telephone system shall be installed to provide telephone services to the public and the ancillary areas of the rail system.
- B. Included in the telephone system shall be:
- Administrative telephone (ATEL)
  - Emergency telephone (ETEL)
  - Passenger assistance telephone (PTEL)
  - Maintenance telephone (MTEL)
  - Gate (fare) telephone (GTEL)
  - Public Telephone Service
  - Elevator Telephone (LTEL)
- C. Equipment failure alarms from each telephone subsystem at each location shall be provided to the SCADA subsystem at each station. All ETELS shall be provided with line status monitoring.
- D. All phones will report their locations to the ROC or other places requested by Metro.
- E. All telephones must have a dedicated line (no party line).
- F. Public Telephone shall be provided by the local telephone company and will not be part of the Metro telephone system. The location of public telephone shall be determined on a site specific basis near passenger stations and parking facilities appropriate. In underground stations when public telephones are provided, at least one Telecommunication for Deaf Device (TDD) shall be furnished

### 9.7.2 IP Telephony System

- A. IP Telephony System will be a network based Voice over Internet Protocol (VoIP) telephony system. Call control and messaging server clusters to be designed to fail over to geographically diverse servers. IP Telephony system includes:
1. IP network to be configured for Quality of Service to give voice traffic priority.
  2. IP telephones shall be configured to encrypt voice traffic.
  3. Adequate IP network security shall be provided.
  4. Gateways and VoIP routers geographically diverse for redundancy.
- B. IP Telephony System Design
1. The IP Telephone System shall be designed for console-less operation with dial service from telephone sets, auto ring down service from ETELS, and public address access from telephones with keypads.
  2. The equipment shall be digital solid-state, modular design, utilizing the same Unified Communications Manager with the latest hardware and software technologies.

3. Existing Communications Servers are to be used if already in place in Metro's network. Metro's intent is to build a single Communications manager cluster to provide call control and messaging for the entire system.
4. The hardware and software design shall be such that incremental increases in telephone lines, and modifications of user data (adds, moves, or changes) may be easily accomplished without affecting service to any existing lines.
5. Dial-up service: The system shall provide station to station direct dialing, capable of processing calls to/from any point in Metro's telephone system. IP telephony users shall be able to go off-hook and dial any network number, regardless of location or serving IP Telephony system, and the system shall automatically complete the call to a system telephone set or route it over network lines for switching by the existing main PBX system, whichever is applicable.
6. The system components include Ethernet switch, gateway and VoIP router as well as the telephone instruments. IP telephones can be powered by using Power over Ethernet (PoE), while it is applicable.

C. IP Telephony Servers and Gateways Requirements

1. Rack mountable inside a communication equipment cabinet. Alternative mounting arrangements are acceptable subject to Metro approval. Physical dimensions, construction, mounting data (wall and/or floor), and enclosure locking mechanism shall be submitted.
2. Employ a five-digit dial plan compatible with Metro standards. The software must determine if the number dialed is within Metro's IP network or off net. No access level (e.g. "9") shall be required to dial any network number.
3. Analog phone gateways will determine all analog telephony devices. These gateways convert analog traffic to IP and are under the control of the communications manager.

**9.7.3 Administrative Telephone (ATEL)**

The ATEL group shall be multi-line phones with displaying, hold, conference, and transfer capabilities. They should be installed in TC&C rooms in underground and aerial stations, in conductors' rooms or booths at terminal stations, and at the ROC.

**9.7.4 Emergency Telephone (ETEL)**

The ETEL group shall provide priority point-to-point telephone communications for emergency reporting and coordination. Telephones in this group shall ring down to designate numbers.

Telephone instruments in the ETEL group shall be one of three types, to be determined by the instrument location and function as follows:



- A. Hands-free with single-button activation, used at public locations such as in elevators and on public platforms and mezzanines, and requiring no further user action after initial activation. See Provisions for ADA Accessibility Guidelines (ADAAG). (Refer to ADAAG 4.30, DOT 49 CFR parts 27, 37 and 38 and the CalDAG-California Disabled Accessibility Guidebook for guidance). These phones will ring down to CCTV observers at the ROC. Elevator Telephone (LTEL) is the ETEL installed in elevators.
- B. Standard black wall phone (2554 with G6 handset or equivalent), used in ancillary locations. These phones will be programmed to ring down to ROC controllers.
- C. ETELS shall be fault supervised, with alarms reported by SCADA.
- D. ETEL service shall be provided at each passenger station, along the trainway, and at maintenance/train storage facilities. ETELS used in lieu of manual pull stations shall be fault monitored through the fire alarm control panel.

ETEL, as a minimum, specific telephone locations shall include:

- Public mezzanines
- Public platforms
- Fire hose cabinets
- Emergency Management Panels (2 per EMP), provided with outside dialing capability
- Elevators
- Sprinkler valve rooms
- Tunnel cross passages
- Emergency fan rooms (next to fan controls)
- Emergency equipment rooms
- Emergency hatches (emergency exits from underground stations)
- Emergency exit corridors
- Emergency exit stairs
- Blue Light Station (BLS) boxes
- Parking lots and parking structures

#### **9.7.5 Passenger Assistance Telephone (PTEL)**

The PTEL group shall provide priority point-to-point telephone service from all station fare collection areas and any other designated public location to the CCTV observers at the ROC.

Instruments in this group shall be identical electrically and physically to the Type “A” ETEL, except for distinctive activation buttons and signage to differentiate them from ETEL instruments. See Provisions for individuals with Disabilities for ADA requirements. PTEL shall be installed next to each group of TVMs and other locations as specified by Metro.

Gate Telephone (GTEL) is the PTEL installed at both sides of each faregate array.

#### **9.7.6 Maintenance Telephone (MTEL)**

The MTEL group shall provide access to the dial telephone system for maintenance personnel working in the Metro system. MTEL access shall be identical to “B” Type ETELS – standard black wall phones (2554 type with G6 handsets or equivalent).

As a minimum, specific telephone locations shall include:

- TC&C buildings or cabinets
- Signal bungalows or cabinets
- TPSS building or rooms
- Auxiliary power rooms
- Electrical rooms
- Elevator machine rooms
- Cross passages
- Staff security rooms
- Mechanical rooms
- Emergency fan rooms
- Custodial rooms
- Ejector rooms
- Sump pit rooms
- Cable turning rooms
- Fan rooms

#### **9.7.7 Installation and Number of Telephones**

ETELs and MTELs installed in ancillary rooms should be within 15 feet of room entrances, and all must have a 25 feet handset cord. If the room is larger than 30 feet, there shall be an additional MTEL. TC&C rooms in underground stations shall have an ATEL and sufficient MTELs so that all equipment is within reach of a telephone. All phones must have independent lines.

ETELs in public areas and ancillary emergency egress routes shall be placed in accordance by code for manually activated alarm-initiating devices (NFPA 17.14).

#### **9.7.8 Public Telephone Service**

Facilities for implementing Public Telephone service at or adjacent to station platforms shall be coordinated with the local telephone company. Such facilities may also be provided in free areas. In any case, the location shall not interfere with pedestrian flow.

### **9.8 TRANSIT PASSENGER INFORMATION SYSTEM (TPIS)**

TPIS shall function as a combination of Public Address and Visual Message Signs subsystems providing audio and video information to the passengers and Metro personnel.

#### **9.8.1 Public Address**

##### **9.8.1.1 General**

The public address (PA) subsystem shall provide for general announcements, alerts to existing or pending hazards or emergency warning information to single and multiple zones within individual and multiple passenger stations, yards, shops and central control with access and control from various locations and from the Metro telephone system. The PA subsystem shall also provide for prerecorded announcements and paging via the Metro telephone system.

## A. Functional Requirements

1. The PA subsystem shall provide an effective sound-masking system which utilizes loudspeakers strategically placed to produce uniformly distributed audio throughout the passenger stations, yards and shops and central control areas. Uniform audio in both tonality and sound level, at 5 feet elevation above the walking area, so that normal moving does not result in 5 dB changes in the sound level. The audio inputs shall be prioritized in accordance with Table 9.8.1
2. The power amplifiers shall be on hot standby on a one-to-one basis, being switched to active by a PA supervisory subsystem. The amplifiers shall drive speakers in backboxes in the station, office, ancillary and low bay areas; and horn type speakers in the yard and high bay areas and in station high noise areas such as mechanical rooms and emergency fan rooms. Level of the power amplifier output based on the ambient noise shall be automatically adjusted for the track areas, shop areas, mezzanine and station areas.
3. The PA subsystem shall be fully supervised with failure annunciation of all major system components such as controller, power amplifiers, supervision tone generators and detectors, power supplies, and speaker wiring. Failure reporting shall be via SCADA to ROC using dry contact.
4. The primary means of access to the ROC and Yard/Shops PA systems shall be through the local Metro telephone system via maintenance telephones and digital administration desk sets. Zone selection shall be accomplished using the Dual Tone - Multi Frequency (DTMF) keypad to select any one or all zones for broadcast of audio from the telephone microphone.
5. The primary means of access to the station PA systems shall be from PA consoles located at the ROC. PA consoles shall allow a user to select one or more stations/zones for broadcast of live audio from the console microphone or pre-recorded announcements stored at the ROC or local station control unit. All audio and control shall be transmitted over Ethernet.
6. All station PA equipment shall be powered from the communications UPS. Yard and ROC PA systems shall be powered from the facilities UPS.

## B. Design Criteria

1. The PA subsystem shall comply with NFPA 72 and shall be compliant with listing requirement of the California State Fire Marshall wherever used as part of a combination fire system.
2. Technical Characteristics
  - a. Active Components: Solid-state devices.
  - b. Power Output: As required.
  - c. Headroom: Sufficient to allow a minimum increase in output of 12 dB, without increase in hum, noise, or total harmonic distortion.
  - d. Frequency Response:

- 1) End-to-end Station amplifier to speaker frequency response: 1.5 dB from 100 Hz to 10 kHz, 3.0 dB 10 kHz to 15 kHz.
  - 2) Pre-recorded audio messages shall be capable of being recorded, stored and delivered at CD quality encoding (44 kHz, 16-bit) from both the ROC server and the local station control unit.
  - 3) Live microphone audio shall be encoded and delivered at a minimum of 22 kHz, 8-bit.
- e. Total Harmonic Distortion: Not greater than 1 percent at full rated output.
  - f. Distribution: 70 V nominal, transformer isolated.
  - g. Power Source: Un-interruptible Power supply.
  - h. Overload Protection: All amplifier outputs shall be protected with automatically resetting thermal overload, short circuit and current limited protection.
  - i. PA subsystem shall maintain a uniformly distributed sound level at least 10 dB above ambient station operating noise level measured at 5 feet above floor for indoor stations. Outdoor stations shall be not less than 60 dBA plus or minus 30 degrees off axis, 4 feet above the floor, at vehicle ambient noise level.

The minimum sound level at any point 5 ft. or lower, above the floor sound level shall be:

- 1) Mezzanine: 70 dBA minimum
  - 2) Platform: 78 dBA minimum
  - 3) Yard and High Bay Areas: 78 dBA minimum
  - 4) Ancillary: 70 dBA minimum
  - 5) Low Bay, ROC, and Offices: 70 dBA minimum
  - 6) Horn speakers' frequency response shall be in the range of 150 Hz to 15 kHz.
3. Supervision and Alarms
    - a. The PA subsystems shall be fully supervised with failure annunciation.
    - b. A local annunciator/alarm panel shall:
      - 1) Indicate individually the failure of any supervised circuit or equipment,
      - 2) Annunciate the transfer to a standby power amplifier,
      - 3) Upon failure of standby power amplifier, activate the appropriate annunciator or alarm.
  4. System Input Priorities

Up to five levels of prioritized inputs shall be selected from various sources at the stations, Yard and the ROC PA subsystems. Microphones shall be provided at the EMP/CP and the PA equipment racks to access the station PA subsystem.

Prerecorded voice announcements shall be activated either locally or by remote control from the ROC for information or emergency announcements. Inputs from ROC shall be transmitted via CTS. Remote access to the PA subsystem shall also be provided via dial access from the telephone subsystem. The following inputs shall be provided:

**Table 9.8.1 – Input Priorities**

<b>Priority</b>	<b>Passenger Stations</b>	<b>Yard/Shop</b>	<b>ROC</b>
1st	Station EMP/CP/TCCR Microphones	Yard Communications equipment room Microphones	ROC Communications equipment room
2nd	Metro ROC – Communications Console	Yard Control Tower	Metro telephone system
3rd	ROC - Other Agency*	Metro telephone system	Announcements
4th	Prerecorded Announcements	All other inputs	
5th	All other inputs		

\*Passenger Stations that serve two separate rail transit systems shall be equipped with a PA subsystem having the additional capability of accommodating the second control center between the regular 2nd and 3rd priority levels.

**9.8.1.2 Remote Access**

**9.8.1.2.1 Telephone Access**

Remote access via the telephone subsystem to PA subsystem shall be provided from both the communications and the CCTV operations telephones at the ROC to passenger stations. This feature shall allow the console operators to individually select any passenger station for PA announcements or select any number of stations for group announcements. This is a redundancy feature intended to provide an alternate means of public address announcement in the event of a ROC server or Cable Transmission System outage.

This feature shall allow live audio to be broadcasted via the telephone system. Station selection shall be accomplished by dialing a designated phone extension. If not busy, the call shall be automatically connected. Upon call connection, zone selection shall be accomplished using the telephone Dual Tone-Multi Frequency (DTMF) sequence and shall allow access to any one zone or “all zones” at the station. The call shall automatically end when the ROC caller hangs up or upon ROC caller selection of a hang-up DTMF code (whichever occurs first).

**9.8.1.2.2 Console Access**

Remote access via TPIS graphical user interface consoles shall be provided at the ROC.

- A. Consoles shall allow selection of one or more stations and zones or announcement groups for broadcast of live or pre-recorded announcements.
- B. It shall be possible to select broadcast destinations using a map-based graphical display or a sort-able tabular style display.
- C. Consoles shall allow system maintainers to define announcement groups for quick selection of broadcast destinations. The system shall include the following pre-configured groups:
  - 1. Systemwide, all stations and all zones
  - 2. Systemwide, all station platforms
  - 3. All stations and all zones (one group for each rail line)
  - 4. All station platforms (one group for each rail line)
- D. Consoles shall include a maintenance display that indicates the following information:
  - 1. Status of each remote TPIS station control unit
  - 2. TPIS server status
  - 3. Status of each TPIS console

#### 9.8.1.3 Pre-recorded Announcement Devices

- A. Station Control Unit (SCU) shall be used in all stations for local automatic messages initiated by local contact closures.
- B. Equipment at the ROC shall be capable of recording and storing new announcement.
- C. Equipment shall be provided to allow recording and storing of new announcements on local SCU.
- D. Provision shall be made for ROC Initiation and Selection of prerecorded voice announcements from the ROC console.
- E. The station EMP shall be able to broadcast an emergency evacuation message from the local SCU.

#### 9.8.1.4 PA Zones

- A. Separate zones with separate amplifying systems and speaker systems shall be accessible individually or in combination. Passenger stations typically have one to three zones covering; platform, mezzanine and ancillary areas. Shops and yard areas have typically nine zones and ROC has typically four zones.
- B. Zones for the ROC PA subsystem shall be uniform and provide a sound pressure level of 70 dBA measured on axis of speakers at a point 4-feet above the floor and not less than 60 dBA plus or minus 60 degrees off axis.

### 9.8.1.5 Standby Amplifiers

Hot-standby power amplifiers shall be provided on a one-to-one basis for each power amplifier used in the PA subsystem installation. The hot-standby amplifiers shall be switched to active use by the PA supervisory function.

### 9.8.1.6 Speaker By Local Microphones

Provision shall be made to reduce output level of speakers in close proximity of local microphones to prevent acoustic feedback.

### 9.8.1.7 Noise-Operated Level Adjustments for Power Amplifiers

A. Automatic Gain Control (AGC) of the PA subsystem shall be provided based upon ambient noise levels. The controller shall provide a graduated increase in power output in proportion to the increase in noise level from a preset quiet level.

As an alternative to AGC, additional speakers can be added to provide better coverage.

B. The adjustment range for ambient noise shall be a minimum of 20 dB, but shall never result in a sound level greater than 100 dB as measured 8 feet above the surface.

C. Independent automatic gain or level control shall be provided at each passenger station for the public areas. Automatic level control shall also be provided, independently, for the high-bay machine shop areas and the outdoor track area in the Yard and the high-bay machine shop in the Maintenance-of-Way-Building. Automatic level control will not be required for office zones or equipment rooms.

D. Noise sensing device for each controlled area shall be mounted in each individual enclosure.

## 9.8.2 Visual Message Signs

### 9.8.2.1 General

The Visual Message Sign (VMS) System is a subsystem of TPIS shall provide visual information at selected locations in passenger stations and auxiliary areas. The display of the visual information shall be in compliance with the ADA Accessibility Guidelines (ADAAG) for the hearing impaired, operational and safety-related messages for patron awareness (refer to ADAAG 4.30, DOT 49 CFR parts 27, 37 and 38, and the CalDAG-California Disabled Accessibility Guidebook for guidance). The generation of messages for display at each passenger station shall be provided in both preprogrammed format and real time terminal input. As a minimum, these communications shall be provided on the platforms and mezzanine areas of all stations, at fare vending areas, and at underground entrances.

The VMS shall provide centralized message generator (including message creation, storage and selection), and dispatch functions at the ROC for individual stations, groups of stations, and all station sign activation and display. Each passenger station VMS/TPIS shall accept message inputs from both a centralized processing unit located at the ROC and from local passenger station inputs. Passenger station inputs consist of pre-programmed messages emulating the pre-programmed public announcements activated



from the passenger station's Emergency Management Panel and from train control/signaling system equipment.

All station message sign units shall be:

- A. For LRT 42" (diagonally measured) LCD monitors or LED signs shall be environmentally housed to prevent damage from moisture, dust, and vandalism. Sign units installed in outdoor environments shall be fabricated for direct sunlight exposure and protection from ultraviolet, rain and atmospheric damage. Outdoor signs shall be equipped with the latest technology display devices to ensure readability in direct sunlight using reflective shielding of signs, and display device illumination intensity of the sign's display characters. The LCD monitors should be installed above map cases and near fare collection ticket vending machines. LED signs should be installed along the edge of the platform and areas as required by FLS.
  
- B. For HRT 46" (diagonally measured) LCD monitors shall be environmentally housed to prevent damage from moisture, dust, and vandalism. The LCD monitors should be installed in the following areas:

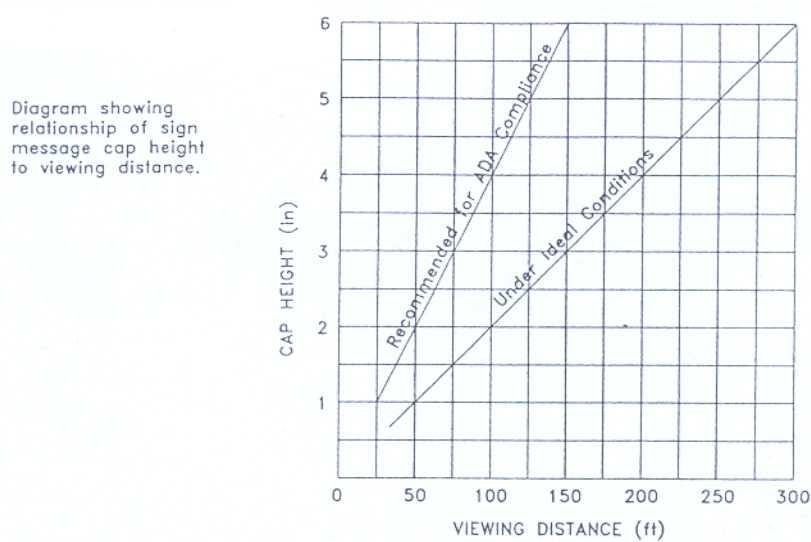
- above map cases;
- near fare collection ticket vending machine;
- along the edge of the platform;
- at grade level station entrance;
- areas as required by FLS

All signs shall have a minimum character size lettering compliant with the ADA Accessibility Guidelines (ADAAG). Refer to ADAAG 4.30, DOT 49 CFR parts 27, 37 and 38, and the CalDAG-California Disabled Accessibility Guidebook for guidance. The character and number height shown on VMS versus viewing distance shall be shown as Figures 9.8.1 and 9.8.2.

Message display shall include fixed position message, left to right scrolling, rolling and flashing functions. Other unique display capability such as special character set generation and top to bottom rotation of messages are acceptable.

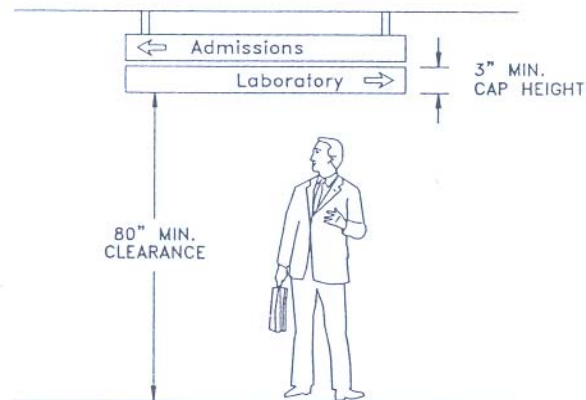


**Figure 9.8.1 Character & Number Height Versus Viewing Distance**



All signs must be installed at a height accessible with an eight foot ladder. If this is not practical, then fall protection must be designed per OSHA guidelines.

**Figure 9.8.2 Typical Overhead Signage**



### 9.8.2.2 System Requirements

The VMS/TPIS System shall be configured using a standard computer system. Passenger station display signs shall be remotely accessed by the ROC-located computer via the cable transmission system. Data transmission to and from the ROC VMS computer and each passenger station display sign shall be transmitted over Ethernet. Note that the VMS computer system may be a shared device, part of the PA system.

All interfaces between the passenger station VMS system and other systems shall be accomplished in the train and control communications room or communications signaling building. Interfaces include train control or signaling system and public address system activation switches to the station Emergency Management Panel.

Power for VMS system equipment located in the train control and communications room or communications-signaling building shall be from the uninterruptible communications AC power distribution system.

### 9.8.3 Transit Passenger Information System Automatic Announcements

The Visual Message Sign (VMS) subsystem shall function in conjunction with the PA subsystem. For the pre-programmed messages VMS shall be able to display equivalent text as announced on the Public Address (PA) subsystem simultaneously for the hearing impaired passengers, in compliance with the ADA Accessibility Guidelines (ADAAG). (Refer to ADAAG 4.30, DOT 49 CFR parts 27, 37 and 38 and the CalDAG-California Disabled Accessibility Guidebook for guidance).

The TPIS system shall interface with the train control and/or other vehicle detection system to provide information to the passengers. The System shall provide automatic announcements that include:

- Information on route, final destination, time of arrival of the next three trains approaching a particular platform – “Next Train”. The system shall indicate “The train is arriving, please stand clear” for trains predicted to arrive within 30 seconds of the reported train control or other vehicle detection transmission.
- Information on service interruptions or delays such as “The approaching train is not in service, please stand clear”
- Emergency instructions such as “Evacuate Station”
- Prohibitive instructions such as “No Smoking, Eating, or Drinking”
- News, sports, weather
- Commercial advertising
- Day, Date, and Time synchronized to a master clock at the ROC
- Other pre-recorded messages to be determined by Metro

The software shall generate arrival messages as described above.

## 9.9 CLOSED-CIRCUIT TELEVISION

### 9.9.1 *Functional Requirements*

The Closed Circuit Television (CCTV) system should be designed for every day safety and security requirements as well as revenue protection, anti crime and anti terrorist applications requiring the identification of unknown people and objects depicted within images.

Stations will generally function unattended. The CCTV subsystem shall provide visual surveillance of designated passenger platform areas, and intersections near platforms, elevators and escalators to aid in safety, security control and assistance to patrons. The subsystem shall provide monitoring capability of all cameras at the ROC. The CCTV subsystem shall provide video recording of all cameras in the transit system.

Street level access shall be available to the CCTV and Network system for all subway and elevated (not at grade) stations by way of a laptop hook-up.

#### A. Passenger Stations

IP Pan/Tilt/Zoom (PTZ) cameras shall be installed to permit monitoring of the station, platform, and plaza areas:

- 100% coverage should be required in the public areas of the station with cameras at their “home” position (in other words, 100% coverage should be achieved without requiring PTZ).
- TVM/SAV equipment and areas (front side of equipment) including passenger assistance telephone (PTEL) and gate telephones (GTEL), and the Paid Areas. For fare collection barrier system requirements see fare collection Section 9.2.
- Passenger loading/unloading areas on platforms
- Entrances from public areas to authorized ancillary areas.
- Additional corridor specific locations (e.g. intersections at entrances to stations, emergency exit areas, security sensitive areas, etc. as required by the transit security design consideration. As described in Section 12)
- Pull-out areas adjacent to platforms

As a minimum, camera placement should be one per 75'-0” of viewing area.

- Cameras need to look out, as well as in, to the station on the plaza level; in other words, camera views should show whether a station is “being watched”.
- The entire plaza level, including bike-parking areas should be covered.
- All cameras shall be equipped with video level driven auto-iris lens. Cameras shall view a subject area free of facility impairments such as building columns, signs, and lighting fixtures.
- All CCTV camera signals at passenger stations shall be transmitted to the ROC for viewing.

The locations include the security sensitive areas as required by transit security design considerations which are described in Section 12.

## B. Parking Structures and Lots

CCTVs shall be provided for specific locations in parking lots, parking structures.

- 1) PTZ camera should be installed to provide full coverage in parking lots.
- 2) PTZ cameras should be installed in parking structures in the following locations:
  - a. Elevators,
  - b. Elevator lobbies (on each level),
  - c. 100% coverage of parking areas,
  - d. Enclosed Stairways,
  - e. Entrances and exits.

Provision shall be provided for future Automatic License Plate Recognition (ALPR) cameras to be installed at the vehicle entrances and exits.

Power and communication conduits, two (2) x 1" minimum, shall be provided from CCTV hub location to all public and employee parking structures and lots associated with LRT or HRT passenger stations for surveillance, and additional conduits shall be provided for future ALPR cameras. The conduit stub-ups shall be designed and installed at locations/intervals to provide comprehensive surveillance of the lot or structure. Actual camera quantities and camera grouping will be used in determination of actual conduit size.

## C. Wayside

PTZ cameras shall be installed to monitor all intersections where the trains are in street run, and intersections where an interlocking is located, the cross passages, tunnel portals, bridges, yards, and other areas required by Section 12, Safety, Security and Systems Assurance.

## D. Elevators and Escalators

Dedicated fixed cameras shall be grip free vandal proof corner mounted that give full coverage and field of view of the cab interior and elevator entrance.

Dedicated IP fixed cameras should cover elevator cab with door opening on one side of the cab. For each elevator cab with doors on both sides of the cab, two cameras shall be corner mounted.

Dedicated IP PTZ cameras shall be used to monitor elevator entrance areas from the outside of the elevator on plaza, courtyard or platform (etc.) areas.

Dedicated IP PTZ cameras shall be used that monitor each escalator at each landing (both top & bottom areas).

### 9.9.2 Design Criteria

#### A. General

- The CCTV system shall be TCP/IP based video transmission network system.
- IP PTZ cameras shall be used in CCTV system design, wherever it is possible.

- The CCTV picture characteristics shall be as follows:
  - NTSC color format
  - The CCTV subsystem shall be capable of supporting to following video resolutions and shall be user adjustable at the ROC console:
    - Up to 30 fps (user selectable 5, 15 or 30) at CIF (360x240);
    - Up to 30 fps (user selectable 5, 15 or 30) at 2CIF (720x 240 or 640x480)
    - Up to 30 fps (user selectable 5, 15 or 30) at 4CIF (720x576)
  - Minimum monitor resolution shall be 720 lines
- The camera shall provide a usable video signal (as defined below) over the entire specified range with a scene illumination as low as 1.0 foot-candle (fc). The camera shall detect and render 10 shades of gray from the EIA TV resolution chart with 5 fc illumination.
- Minimum Ambient Illumination: One foot candle when emergency lighting is activated.
- The signal-to-noise ratio over the entire system length shall be no less than 44 dB (for analog portion of the system, if used).
- The IP PTZ cameras can be powered by using Power over Ethernet (PoE), wherever it is applicable.
- The cameras could use cat5e or above cable or fiber optic cable where needed. CCTV systems shall be configured in a hub and spoke arrangement with local recording being undertaken and images compressed then being transmitted back to the ROC via a CTS or possibly wireless network.

#### B. Cameras

- Elevator Camera shall be Vandal resistant, IP66 (ingress protection) rated and corner mount color CCD type that gives full coverage and field of view of the cab interior and elevator entrance.
- Elevator camera housing shall be constructed of stainless steel with polished stainless steel finish.
- It shall be suitable for surface/corner mounting in an elevator cab.
- The IP PTZ cameras shall have smoked glass.
- The IP PTZ cameras shall not have make or model number visible on the camera housing.
- Cameras shall be compatible with the picture characteristics and shall, in addition:

- Produce a picture with no geometric distortion
  - Signal-to-noise ratio shall be at least 48 dB (for analog portion of the system, if used)
  - The line loss between each camera and the multiplexer or recorder that the camera is connected to shall not cause the signal to noise ratio fall below 45dB.
  - Video output shall be a composite video signal with 1.0 V peak to peak (negative synch) at 75 ohms for analog cameras.
  - Shall use Gamma correction (0.45 to 1.0, adjustable) and shall have an automatic light range that results in not more than  $\pm 3$  dB video output change with a 1000:1 change in scene luminance. There shall be no sensor damage in the image sensors within the specified light range.
  - Be housed in corrosion-resistant, vandal-resistant environmental enclosure with reflection inhibiting, shatterproof glass or polycarbonate viewing port. Enclosures shall be weatherproof when installed in exposed environment.
  - Be equipped with sunshades when used outdoors as required to prevent unwanted reflections into lenses. Consideration to object/target clarity will be evaluated when applying sunshades to camera housings. Cameras located in an environment that is subject to rain shall be sealed to prevent moisture infiltration and build-up.
  - Camera housings and mounting apparatus shall use anti-corrosive (rust-proof) material.
  - Lenses: Focal length and Fields of View (FOV)
- The selection of lenses will be dictated by the field-of-view to be covered by each camera, as well as by the size of the camera's detector. For cameras placed to record images at a point of transactions, such as a front of fare machine or parking approach , the area of interest (e.g., face, license plate) should cover approximately 15 percent or more of the camera's field-of-view (based on the recommended minimum resolution).

Examples:

1. For an average human head that is six-inches wide, a three-foot-wide field-of-view will meet this guideline.
  2. For a license plate width of approximately 12 inches, a six-foot-wide field-of-view is sufficient.
- The focal length necessary to achieve an approximately three-foot-wide field-of-view for a given detector size and camera-to-subject distance is provided in Table 9.9.1 below. The camera must be in focus at the position of this subject.

**Table 9.9.1**

**Approximate Focal length needed for a 3 wide Field of view**

	Distance to Subject (in feet)	2 feet	5 feet	10 feet	15 feet	20 feet	30 feet
Camera Optical format (in inches)	1/4"	2.3 mm	5.9 mm	11.7 mm	17.6 mm	23.5 mm	35.2 mm
	1/3"	3.1 mm	7.8 mm	15.7 mm	23.5 mm	31.3 mm	47 mm
	1/2"	4 mm	10.1 mm	20.2 mm	30.3 mm	40.4 mm	60.7 mm

Differences in the units used to describe these resolution recommendations are due to the differences in the industry recommended practices used to describe them.

PTZ cameras by their natures are adjustable and these calculations should be considered for a “home” or “cage” position.

Cameras that provide overviews of interior and exterior locations should have their focal lengths selected so as to meet the field-of-view requirements of the facility. However, exit cameras should have sufficient depth-of-field of at least three to four feet for walking pace objects to ensure that subjects exiting the facility will be in focus.

Field of view (FOV) relates to the size of the area that a camera will see at a specific distance from the camera. The field of view is dependent on lens focal length and camera format size.

**C. Camera Mounts**

Manual adjustable mounts shall be provided for each camera. Positive position locking shall be provided. Cameras shall be located unobtrusively and at as high an elevation as possible to maximize field of view and reduce vandal access, but low enough to access using an eight foot ladder. If cameras are located higher than this, fall protection must be installed per OSHA guidelines.

**D. Camera Identification**

A discrete camera ID consisting of a minimum of sixteen alphanumeric digits in ASCII-II code shall be superimposed on each camera video to identify the camera location.

**E. Wayside Transmission**

Video transmission between each passenger station and the ROC monitoring areas shall be by Fiber Optical Cable Transmission (FOCT) system. Each passenger station and TC&C room shall be serviced with sufficient supporting equipment capacity to add 40% additional cameras for expansion. (Example: Nine cameras plus 40% equals 13 cameras total.)

The fiber optic network for the CCTV system shall provide equipment at each station/location for multiple CCTV camera inputs. The optically transmitted signal shall be recreated at the ROC for distribution to the various monitors.

**F. Interface**



The CCTV system shall be interfaced with ETEL, LTEL, GTEL, and PTEL such that activation of ETEL, LTEL, GTEL, and PTEL within viewing distance of a CCTV camera shall cause the video scene from that camera to be automatically displayed at the ROC on the CCTV Observer console (event) monitor (camera call-up). If several calls are originated, the images shall be rotated on the console (event) monitor. The image shall be maintained until ETEL, LTEL, GTEL, and PTEL call(s) is terminated. After that the event monitor should display the last camera image prior to call-up event.

#### G. SCADA Alarms

CCTV individual alarms shall be transmitted from each station to the CCTV or SCADA console in the ROC. The alarms will be based on the CCTV system, its alarm capabilities, and the project needs.

The alarms, at a minimum, shall include:

- Power failure
- CCTV communications equipment failure (transmission equipment)
- CCTV cable failure
- Video loss

#### H. Video Recording System

- All CCTV camera signals shall be recorded in real time at the station network video recorder. The selected camera signals can be controlled and routed from remote sites to the CCTV observer consoles in ROC..
- A CCTV management system shall control and record the selected CCTV video images into the network video repository server in ROC. The playback provision shall be able to display recorded images.
- The station network video recorders (NVR) shall have a video output for the console monitor to monitor recorded images. Controls for the NVR shall be provided at the console in ROC. The station NVR shall be compatible with the CCTV subsystem and shall have the following characteristics:
  - The video recorder shall be able to record images seen on all CCTV monitors in following resolutions and shall be user adjustable at the ROC console:
    - Up to 30 fps (user selectable 5, 15 or 30) at CIF (360x240)
    - Up to 30 fps (user selectable 5, 15 or 30) at 2CIF (720x 240 or 640x480)
    - Up to 30 fps (user selectable 5, 15 or 30) at 4CIF (720x576)
    - Recording Time: as recommended by Transit Security Design Considerations but in no event less than 30 days at 30fps at 4CIF
  - Operating Temperature: 40°F to 140°F



- Audio Dubbing: Required
- Controls:
  - o Record
  - o Playback
- Image search by date and time
  - o Stop
  - o Pause
- Other (as recommended by Transit Security Design Considerations)

### 9.9.3 **Operation: Continuous Duty**

#### A. CCTV Monitors

Individual monitors of minimum diagonal length of 21” mounted at each CCTV Console. CCTV wall displays shall be provided for full-screen sixteen way split (sixteen images), and quad format viewing of selected camera pictures.

It shall also be able to apply time and date stamp on each recording. All monitors shall display images in color and recording devices shall record images in color.

#### B. Digital Signatures

In order to digitally sign a file, all data/video file, which is to be protected, should be passed through a hashing function. The hashing function should produce a large checksum value for the file, which should be then encrypted using the private key. The two most recognized and acceptable by Metro hashing functions could be used for digital signature technologies are MD5 and SHA-1.

The American Bar Association (Digital Signature Guidelines: <http://www.abanet.org/scitech/ec/isc>) describes digital signatures as using public key cryptography and a 'hash function' derived from the message itself. The hash function is an algorithm created from enough of the message data to ensure that it could only be created from those data. The message and the hash function are then encrypted with the sender's private encryption key to make a digital signature which is unique. The receiver decodes the message with a related version of the encryption key previously given to the intended recipient by the sender (or held by a trusted third party). The message is verified by computing the hash function again and comparing it with the original.

Watermarks cannot be used for traceability of video evidence.

### 9.9.4 **Triggers/Video Analytics (Analytical Video Systems – AVS)**

In some situations, systems may include triggers that lead to the recording of images at a variable rate, or in a sequence, that differs from the normal operating mode. An example of this would be to change from a low resolution recording mode to real-time mode when triggered by an alarm. (15 fps to 30 fps or better). Another example would

be to create an alert from an otherwise unmonitored camera if motion was detected in the field-of-view of that camera using AVS.

Test recordings should be made to ensure that activation of the triggers, trip wires or other AVS based alarms and subsequent operation of the incident recorder, does not have an adverse effect on the quality of the recorded images and meets a minimum playback resolution of horizontal resolution stated in the section 9.9.2A. Video Analytics (VA), or Analytical Video Systems (AVS), are increasingly being used within Metro to aid operators and controllers. Where numerous screens are used within an ROC, VA systems aid operators to direct their attention at areas of interest depending on how and what type of VA is employed.

Passive infrared detectors can be added to a systems network and tied to individual or groups of cameras that can get the attention of an operator when triggered. There are manual triggers and automatic triggers. The manual triggers initiated by AVS generally more reliable although much simpler in operation as they are fed back to the ROC separately on the network and then “paired” with a group of cameras at the ROC. AVS, or software based VA, is increasingly becoming more advanced for detecting abnormal behavior as well as triggering events based on intrusion. Automatic VA systems are usually housed at the ROC on separate servers having camera feeds directed into them. Software based analysis is then performed on these feeds and alerts generated. Metro will define what features to detect or monitor based on the project specific. Metro will ensure that these can be “measured” and “tested” in some way to ensure that false alarm rates are kept to a minimum. VA is not a substitute for processes and procedures that must be put into effect when a VA alarm or alert is generated.

## 9.10 CABLE TRANSMISSION SYSTEM (CTS)

### 9.10.1 General

The Cable Transmission System (CTS) shall incorporate both the backbone fiber optics transmission system and communications metallic cable distribution within the confines of the yard, wayside/guideway, passenger station area, control center, etc.

#### A. Backbone System

The backbone CTS shall be an optical fiber-based system to mitigate electrically-induced interference to the communications system, and shall provide all voice, data, and CCTV video transmission circuits between the ROC and all fixed locations on the LRT and HRT System (as applicable). Fiber optic cable and terminal equipment shall be equipped for 1:1 protection.

#### B. Functional Requirements

1. The system shall operate in a ring (SONET) arrangement, with self-healing equipment in event of a fiber optical cable or equipment failure. Redundant cable paths, with space diversity, must be employed to make possible this self-healing ring capability needed to provide fault-tolerant reliability for all functionally critical nodes. Self-healing shall complete fast enough to not drop any active telephone call. All equipment comprising the CTS shall have carrier class reliability. The backbone design must not have any single point of failure.

2. As a minimum, SONET backbone rings should consist of two fiber cables with 144 or above single mode fiber strands.
3. Voice, Data, and CCTV video on the CTS shall operate on the fiber optic transmission service at a bit rate capable of transmitting the type and quantity of signals required without impeding the operation of the LRT or HRT system. The CTS shall provide voice grade channels for telephone, public address audio, radio audio and control, and data channels for the SCADA, UFS, TPSS, Train Control and other subsystems, and video grade channels for CCTV subsystem. Bandwidth and quality of service shall be allocated in accordance with the specific subsystem requirements.
4. The CTS network shall be configured to maximize reliability and will feature redundancy in the event of equipment or cable failure.
5. The Metro telephone system shall have dual paths within the cable transmission system. Loss of a fiber optic line or repeaters shall cause the remote multiplex unit to switch to the redundant transmission link.
6. Full featured CTS management tools shall be included that allow system configuration and alarms to be managed from a single remote location in ROC. Maintenance and diagnostic capabilities shall be provided at each local node.

### 9.10.2 Design Criteria

1. The CTS shall consist of, but not be limited to, the following components:
  - a. Transmission Lines (metallic cable and fiber optic cable)
  - b. Transmission Line housing
  - c. Transmission line termination apparatus
  - d. Transmission line supervision with automatic transfer apparatus may be either internal or external optical equipment.
  - e. T-Carrier and FT-Carrier or SONET Equipment with the following MINIMUM functions:
    - 1) Common Logic Redundancy
    - 2) Power Supply Redundancy
    - 3) Output Redundancy (Either Constant or Hot Standby for optical equipment).
    - 4) Remote Alarm Annunciation
    - 5) At ROC, dual redundant nodes shall be provided.
  - f. Mounting Racks and Cabinets
  - g. Duct Liners
  - h. Voice Frequency Patch Panels
  - i. Fiber Optic Patch Panel
  - j. Network switching and routing equipment
2. Electro-optic Modulators or Optical Transmitters (sources), converting an electrical signal input to an optical signal by modulating a light source, shall transmit information via an optical fiber of the fiber optic transmission link. Sources shall be capable of operation at a data rate compatible with the type of data transmitted.

3. All local distribution cables shall be placed in galvanized rigid steel conduit or totally enclosed raceway. Other Materials are acceptable only for backbone cable in main duct banks when encased in concrete or buried under a minimum of 24 inches of cover.
4. All outside plant and tunnel metallic distribution cables shall be surge protected at all main and subsidiary distribution frames and at all cable terminals. Protection shall be by 3-electrode fail-short gas tube or electronic protectors.
5. Optical Cable

All outside main backbone optical fiber cable shall be gel-filled and armored for rodent protection. Sufficient fiber strands shall be provided to support the CTS subsystem plus future extensions and 25% spare. Safety-critical signals will be backed up by another independent transmission path or means.

6. Backbone and Local Distribution - Metallic Pairs

Local CTS distribution for voice, data, and CCTV video circuits shall be twisted pair, using standard telephone cable color coding.

All outside plant cables shall be 22 AWG minimum, gel-filled, foam/skin insulated conductors that meet Rural Electrification Administration (REA) PE-89 and shall be gopher-protected. All cables shall be sized for initial requirements plus 25%. No outside plant cable shall be less than 12 pairs.

All main riser cables shall be 22 AWG minimum, and shall meet REA PE-22 or PE-89. No cable shall be less than 12 pairs.

Inside wire from distribution terminals to instruments shall be 22 AWG minimum, and have a characteristic impedance of 105 ohms + 15%. All telephone instrument and jack appearances shall be served with a minimum of three (3) dedicated pair.

All outside main and riser-paired cables shall be shielded.

REA PE-39 cables shall not be used as a substitute for PE-22 or PE-89 cables.

## **9.11 SUPERVISORY CONTROL AND DATA ACQUISITION**

### **9.11.1 General**

The Supervisory Control and Data Acquisition (SCADA) subsystem shall provide supervisory control of the Train Control (TC) system, auxiliary and traction power, the Environmental Control System (ECS), facilities, and other systems and subsystems. Status reporting, information storage and retrieval, alarm processing, trending and incident and operations reports shall be provided via overhead displays, ROC consoles, archive media drives and hard disc storage.

As a part of initial system sizing, the SCADA system shall be provided with the processing capability and memory required for Rail Projects, including communication circuits, application programs, database, displays, and logs. The system shall permit database generation and changes, as well as the compiling, debugging, and integration of new software. Schematic, one-line, pictorial, and alphanumeric displays shall be generated, altered, or deleted on-line by use of interactive programs and LCD terminal keyboards. All application programs shall be implemented with the capacity for all Rail Projects. The SCADA system shall be designed for ease of expansion and alteration in an economical and efficient manner, to facilitate future Rail Projects.

The maintainable system life of the SCADA system shall be at last 25 years.

### **9.11.2. Functional Requirements**

1. The SCADA subsystem shall facilitate the transmission of indications and alarms from the remote terminal units (RTUs) to the ROC and the transmission of controls from ROC to the RTUs. All transmissions shall be through the CTS. The SCADA transmissions shall include:
  - a. Traction power alarm, indication and control signals
  - b. Train control alarm, indication and control signals
  - c. Mechanical equipment, load shed control signals and auxiliary power alarms
  - d. Gas alarm signals
  - e. Tunnel ventilation alarm, indication and control signals
  - f. Communications alarms
  - g. Miscellaneous electrical/mechanical system status and alarms.
  - h. Any other interfaces and capabilities required for safe, efficient, and effective remote operations.
  - i. All Communications systems control, status/indications and alarms
  - j. Passenger station subsystem alarm, indication and control
  - k. Fire suppression summary status indicators.
2. Remote terminal units (RTUs) – See Appendix A - shall be provided to interface local and remotely located devices with the SCADA subsystem. Analog input, discrete inputs, discrete output and local subsystem communications interfaces shall be provided. The RTU shall provide isolation between the signal source and the CTS units. The preferred design is IP based communications (See Appendix B).
3. Redundant server processors shall be provided and configured in a primary/backup mode to support automatic fail over to the backup processor upon failure of the primary processor.
4. Signal transmitted from the RTUs to the processors at the ROC shall be processed to provide monitoring information for all subsystems listed above, generate commands to be transmitted back to the RTUs, provide information for displays and alarm processing at the control consoles and store information and historical data for future processing.
5. The SCADA subsystem shall provide monitoring of the seismic detectors and gas sensors and generate commands for emergency operation procedures for the control of ventilation fans and dampers. Communication shall be provided via RTUs on the CTS for data exchange between the ROC and the equipment located in the passenger station TC&C rooms, yard, shop and maintenance areas.

The detail requirements of SCADA RTU are described in Appendix B and C.

### 9.11.3. Design Criteria

1. Equipment and associated peripherals for the SCADA subsystem shall include, but not be limited to, the following:
  - a. Redundant server processors
  - b. Data storage peripherals: Disc drives and archive media drives
  - c. Hard copy printers: High-speed gray scale and color printers
  - d. Control consoles consisting of:
    - Dual head, flat screen monitors
    - Keyboard
    - Computer interface
    - Cursor positioning devices.
2. SCADA server CPU usage does not exceed 90% for more than ten seconds at any time. The CPU usage shall normally average less than 40%.
3. Remote and ROC RTUs shall operate in a full duplex mode with each continuously scanning and reporting the changes of status of indications and commands. The RTUs shall utilize reliable, error detecting communications protocols. Capability shall be provided to scan each data point at an assignable rate, selectable between one second and 30 seconds per scan cycle.
4. A computer platform consisting of redundant server processors shall perform the real-time data acquisition processing, generation of supervisory control commands, alarm generation, database management, execution of diagnostic and maintenance programs.
5. Offline simulation and playback functions shall be provided.
6. Hard copy peripherals (e.g. printer) shall interface with the ROC computer. In addition to the generation of reports, these hard copy peripherals shall be capable of printing out all alarms that are stored in redundant databases, including the date and time at which they occur.
7. Alarm displays shall be designed with latching circuitry. An annunciator shall sound an initial alarm and the visual indication shall be illuminated. The audible alarm shall have a silencer function. The visual indications shall remain latched until the alarm is cleared and the indication is reset. Both audible and visual reset provisions shall be provided on a graphical display on the SCADA console.
8. Multi color displays with direct manual access to the cursor shall be used for English language alphanumeric display of status indications, alarms and controls and graphic display of the schematic diagrams and plans.
9. An emergency condition shall immediately be displayed on the operating displays to permit monitoring of device actions by the operator. In the event that a sequence of actions has been initiated, the appropriate devices shall flash until the sequence has been completed.

10. A horn/strobe device shall be activated by Fire/Life Safety critical alarm indications as the SCADA also serves as a remote fire alarm annunciator.

## 9.12 FACILITY AND EMERGENCY MANAGEMENT SYSTEM

### 9.12.1 General

Facility and Emergency Management (F&EM) System consists of high availability logic controller, Emergency Management Panel (EMP), Auxiliary Emergency Management Panel (AEMP), and Remote CCTV Jack Box.

An Emergency Management Panel (EMP) shall be provided at designated locations at underground and aerial stations, trench structures, and mid-line vent structures (Reference: Fire/Life Safety Criteria). Each EMP shall be equipped with controls, alarms, and status indications, as applicable, for:

- Emergency Ventilation System
- Fire Detection and Suppression Monitoring
- Gas Detection
- Intrusion Detection
- Seismic Detection
- Public Address System
- Escalators
- Elevators

EMP shall include a local SCADA human machine interface (HMI) panel for indication and control of station ventilation and seismic detection, a local CCTV workstation for CCTV cameras monitoring and control, an Intrusion Detection System (IDS) annunciator panel for indication of intrusion alarms, and a remote graphical annunciator for fire alarm and trouble indications. Information shall be graphically overlaid on top of station schematics as well as in tabular data format.

Each EMP shall be equipped with the following communications circuit access:

- Priority Access to local PA system
- Two ETELS (wall phones with outside dialing)
- Evacuation system activation
- Capability for facilitating evacuation of patrons, including controls for homing of elevators, and releasing fare gates
- Intrusion detection alarm
- CCTV monitoring and control
- Remote annunciator for the fire alarm control panel

An EMP shall be located in the vicinity of the underground station entrance at mezzanine level un-paid area to which the fire department will respond. Locations shall be approved by the Fire/Life Safety Committee (FLSC).

Auxiliary Emergency Management Panels (AEMP) shall be provided at underground and aerial passenger stations which have a secondary entrance not readily accessible to the EMP and shall be used to augment the functions of the EMP. The AEMP shall contain:

- Emergency telephone (ETEL)



- Capability for facilitating evacuation of patrons, including controls for homing of elevators, and releasing fare gates
- PA system access
- Intrusion detection alarm.

A remote CCTV jack box shall be provided outside of the station at-grade level at underground stations in order to manage incidents where entry into the station is not accessible. CCTV jack box also needs to have an intrusion bug, and signage inside listing ROC's phone number. The exact location shall be coordinated with the FLSC.

The locks for the EMP, AEMP, and CCTV box need to be compatible with the Metro keying scheme. Appropriate locks and keys need to be coordinated with the Metro keyshop, and need to be the same as existing EMP keys.

### 9.12.2 Operation

When activated, the EMP shall have control priority over central control of the emergency ventilation. Alarms and indications shall be reported to the EMP and to central control regardless of which entity is in control.

Underground EMP shall have the capability of controlling multiple ventilation zones served by separate F&EM PLCs. Only one EMP or ROC shall have control over a ventilation zone

The following requirements shall be met as far as the EMP/ROC controls and interfaces:

- a. Each and every EVOP (Emergency Ventilation Operational Procedure) scenario shall have a pre-determined fans/dampers configuration, to be implemented upon activation of a single, discrete command from either ROC or anyone at the involved EMPs.
- b. The commands for each and every EVOP scenario originated at ROC and/or involved EMPs, shall be sent to all station local controllers involved in the implementation of the respective scenarios.
- c. ROC and/or EMPs shall also be able to command and receive indication of status and alarms for each and all individual fan and/or damper separately.
- d. Each and every EMP shall have all its function, EVOP and non-EVOP related, replicated at each and every EMP located at the two adjacent stations on each side (when existing). Therefore, the stations shall be "networked" accordingly. Currently operational stations in the existing systems (if any) are excluded of this requirement.
- e. EMPs shall have priority over ROC and shall be able to assume control of all its local functions irrespective of any action originated at ROC.
- f. The priority criteria between EMPs shall be as follows:
  - 1) While one EMP is in full control, the other adjacent EMPs (up to 4) shall be able to request such control.



- 2) The EMP in full control shall receive an indication of such request.
  - 3) The EMP in full control shall have up to 1 minute (with variable settings) to concede or deny the request for full control by the requesting EMP
  - 4) If no action is taken by the EMP in full control within the set time, such control shall be automatically given to the requesting EMP.
- g. In case of failure of any local controller, the respective EMP will have its controls relinquished, and send an alarm to SCADA.
- h. If the F&EM PLC detects that the EMP is offline, then control shall revert to the ROC.

The location of EMPs and their ventilation zone assignments shall be coordinated with the local Fire Department having jurisdiction.

### 9.12.3 Design Criteria

The EMP shall be the intuitively operated touch screens (with back-up keyboard/mouse) used to monitor and control emergency events in an underground or aerial station. It shall have graphical representations of the facilities, with detailed screens accessed from an overview map, which will show key events using Metro's icon system. Additionally, all alarms shall be shown on tabular screens. Emergency ventilation controls and indications shall be graphically accessed, and may show the complete ventilation area.

EMP shall provide the capability to control and monitor individual HVAC equipment in response to smoke/fire and/or gas/seismic detection at the station to implement the followings:

1. Emergency Ventilation Operating Procedures (EVOP)
2. Emergency Gas Operating Procedures (EGOP)
3. Emergency Seismic Operating Procedures (ESOP)

Emergency ventilation controls and indications shall be graphically accessed, and shall show the complete ventilation area.

EMP shall have the capability of controlling multiple ventilation zones served by separate SCADA RTUs.

EMP shall have the features to monitor and control CCTV cameras at the station. The location of EMPs and their ventilation zone assignments shall be coordinated with the local Fire Department having jurisdiction. The design of the EMP will be coordinated with Metro, who will provide screen shots of EMPs currently in use.

F&EM PLC requirements:

1. Redundant CPU,
2. Redundant power supply fed from separate circuits,
3. Continuously supervised redundant remote IO data links.

EMP Cabinet:

The EMP cabinet shall house the following equipment:

1. Telephone panel with two emergency telephones
2. One public address panel with microphone and selector panel
3. One HMI workstation supervised by the F&EM PLC and alarm to SCADA on loss of communications, One CCTV workstation for CCTV monitoring and control, two 21" flat-screen rack mounted color graphic monitors (LCD), with drawer slides for extension of LCDs out of EMP cabinet for maintenance purposes. One screen is for SCADA HMI, and another one if for CCTV monitoring.
4. One fire /gas alarm graphic annunciator and an EVAC microphone interfaced with the FACP
5. One IDS graphic annunciator
6. Cooling slots at top and bottom of cabinet for ventilation.
7. Conduit entry and wiring space at back of cabinet.
8. Wiring terminations secured at back of equipment openings.

In addition, each EMP should have keys necessary for access to all areas of station in nearby lockbox and a designated space for EMP as-built map books and emergency ventilation procedure books (as applicable).

The design of the EMP should be coordinated with Metro, which will provide screen shots of EMPs currently in use. Future EMPs could be designed similarly; however, it is possible that advances in fire/gas products may result in a graphical alarm screen being available from the fire/gas panel manufacturer. If this is the case, fire and/or gas could be shown on a separate (fully fire rated) screen, while other functions would remain on the touch screen monitors.

## 9.13 INTRUSION DETECTION AND CONTROLLED ACCESS

### 9.13.1 General

The Intrusion Detection and Controlled Access (IDCAS) shall be provided for designated rooms and areas at passenger stations, yard and shops and ROC facilities, and facilities/equipment and fences/tunnel portals along the right-of-way, Detection of authorized and/or unauthorized intrusion shall be reported to ROC via the SONET Cable Transmission System (CTS) for recording and to the station EMP.

In general the intrusion detection is considered to be composed of two systems; ancillary intrusion detection and Right of Way (ROW) intrusion detection.

Ancillary (and facilities) intrusion detection is intended to control access to and monitor intrusion of secure non-public areas. Monitoring is primarily a transit security / law enforcement function.

ROW intrusion is intended to monitor unauthorized access to the running rails. Monitoring is primarily a safety function performed by Rail Operations Control and may be interfaced directly to train control and traction power systems for automatic actions as determined by Metro.

**9.13.2 Design Criteria for Ancillary Space****A. Functional Requirements**

Detection of entry into specific rooms shall be reported to central control.

1. Intrusion detection devices shall provide continuous indication of door movement of 1 in. and greater from the fully closed and latched position. As a minimum intrusion detection shall be provided for the following rooms and areas:

a. Passenger stations:

- 1) Traction power substations
- 2) Rolling grilles when provided at station entrances
- 3) Auxiliary power rooms
- 4) Train Control and Communications rooms
- 5) Communications and Signaling rooms and buildings
- 6) Sprinkler valve rooms
- 7) Electrical cable rooms
- 8) Electrical equipment rooms
- 9) Emergency exits and platform end gates
- 10) Emergency exit hatches.
- 11) Agent office
- 12) Battery rooms
- 13) Corridor doors leading from public areas to ancillary areas
- 14) Mechanical rooms
- 15) Emergency fan rooms
- 16) Elevator equipment rooms
- 17) Cable turning rooms
- 18) Other ancillary room doors, as needed

Card key access also shall be provided for 1) through 5) above listed facilities. Roll-up grilles will require two card readers; one on each side of the grille.

Card key access shall also be provided for 13) to suppress alarms for authorized entry.

Intrusion for 7), 8), 11), 12) and 18) shall be recorded as an event only for historical reporting and shall not trigger an intrusion alarm when the area perimeter is also secured by IDS.

An intrusion concept should be developed for large facilities (like underground stations) so that the premises are protected, but not over-protected (too many alarms may result in the system not being utilized). Attention should be given to protecting the perimeter – all of those doors that are dividing the public from non-public areas. In any case, the doors requiring card readers will remain the same.

The system shall be designed to minimize false alarms. A combination of key bypass switches and extra card readers, or other technology which keeps alarms from being sent when a key is used to unlock a door, should be used

so that all alarms are valid alarms, not employees going about their daily business.

b. Yard and shop facilities and central control:

- 1) Communications equipment rooms
- 2) Data processing rooms
- 3) Operations control rooms
- 4) CCTV observation rooms
- 5) Operations computer rooms
- 6) Yard control Towers
- 7) Train control rooms/building.
- 8) Electrical equipment rooms
- 9) Mechanical rooms
- 10) Traction power substations

Central Control facilities shall also have card key access.

- c. Intrusion alarms shall be indicated to the SCADA RTU, the IDCAS server/workstations at central control and at the EMP. Intrusion indication to the SCADA RTU shall be from an auxiliary output contact of the local door control unit.
  - d. Local audible alarms with configurable automation timed resets shall be provided for intrusion detection at emergency exit doors.
  - e. Request to exit devices shall be installed to inhibit intrusion alarms during egress from the secure side of any monitored entrance. Internally wired request to exit hardware integrated into doors/frame shall be provided for equipment rooms.
2. The controlled access (CA) subsystem shall include card key readers, validating terminals and hard-copy record printers. Card readers' installations shall be inconspicuous and not easily identifiable to the general public.
- a. The key card shall contain a machine-detectable code indicating unique security classification number (SCN). When an employee uses a key card to activate a card reader adjacent to a controlled door, the subsystem shall release the electric lock if access is authorized for the specific card, based upon door number, time of day, and day of the week.
  - b. The subsystem shall maintain a record on magnetic disk. The record shall include intrusion alarms, diagnostic alarms, all card reader events and authorization status. The date, time, location, card identification, card holder's name, department badge number and SCN shall be recorded with each record. These records shall be retrievable via both computer and hard copy. Functions for archiving and restoring records shall be provided,
  - c. The IDS server at ROC shall be a pair of computers operating in primary/standby configuration with automatic failover. All system configuration and alarm/event data shall reside on RAID protected shared disk memory.

- d. If the subsystem fails or is out of service due to a communications loss with the IDS server, its functions shall transfer to a backup mode of operation. While the backup mode is in effect, access to a door shall be granted when a zone code ascribed to the SCN on a card coincides with the zone code assigned to the door where the card is presented.
- e. If both the subsystem and its backup mode fail, door releases shall be effected from a remote terminal. In the event of a total failure, a mechanical means of activating door releases for exiting through the controlled doors shall be provided. This provision shall allow the preselection of the appropriate failure mode, be it locked or unlocked, for each specific door.
- f. Local audible alarms with configurable automation timed resets, and key bypass switches, shall be provided for intrusion detection at emergency hatches.
- g. Local audible and visual alarms with configurable automation timed resets shall be provided for intrusion detection at platform end gates. Key by-pass switches shall be provided so that employees can use the gates without setting off alarms.
- h. The controlled access or intrusion detection system shall not inhibit egress.
- i. The subsystem shall provide the capability of authorizing and voiding a single SCN or a group of SCNs. The subsystem shall provide the capability of assigning employee names, department, badge numbers and zone codes to each SCN. The subsystem shall provide the capability of authorizing combinations of door numbers, SCNs, times of day, and days of the week. The subsystem shall prevent alterations of the data by unauthorized persons and provide capability for changing access codes and validations on a real-time basis.
- i. Emergency exit doors shall have local audible alarms that sound on the public side, with configurable automation timed resets. They shall be provided with card reader on the public side, and request to exit devices on the emergency stair side.
- j. The subsystem shall provide selection capability to print out authorized access and/or print out only rejected access attempts.
- k. Encoding terminals shall be provided for the encoding of key cards with employee name, department, badge number, SCN and zone code. Encoding terminals shall encode key cards singly or in multiple.
- l. Encoded key cards shall be impervious to magnetic fields, dirt, water, oil, embossing, laminating and damage by scratching.
- m. Vandal-resistant, weatherproof, proximity type card readers shall be located at traction power substations, passenger station public areas, main entrance rolling grilles to the passenger stations, TC&C rooms, communications equipment rooms, Yard Control Towers, auxiliary power rooms, electrical rooms, sprinkler valve rooms, and station auxiliary power rooms.

**9.13.3 Design Criteria for Open Space (Right of Way)**

## A. Functional Requirements

## 1. Wayside Intrusion Detection System (WIDS):

The WIDS shall be installed along the perimeter fencing along the right-of-way, wherever it is directed by Metro, (or other Metro approved areas) to warn ROC controller of unauthorized entry into the restricted areas.

- a. The WIDS shall be 24 hr x 7 days, failure rate be less than 1%.
- b. The WIDS shall be a fiber optic intrusion detection system (or other Metro approved means) utilizing a fence-mounted fiber optic vibration sensor cable. The sensor cable shall be an outdoor-grade fiber optic cable rated for aerial and duct installations with a UV-resistant medium-density polyethylene jacket.
- c. CCTV cameras may need to be added as part of the WIDS system. These cameras should feed back into the station CCTV system, as well as being an integral part to the WIDS system.
- d. A wayside intrusion alarm signal shall be transmitted to the ROC via the SCADA system. The alarm signal shall identify the zone in alarm on control consoles and CCTV observer consoles in ROC.

## 2. Tunnel Portal Intrusion Detection System (TPIDS):

The TPIDS shall be provided at tunnel portal entrance areas to warn the train operators and ROC controller of unauthorized entry into the tunnels. Infrared transmitter/receiver beam motion detectors (or other Metro approved method) shall be provided at the tunnel portal entrance along with intrusion warning signals for train operators and intrusion alarm for the ROC.

- a. CCTV cameras shall be installed as part of this system, and will feed back into the station CCTV system.
- b. An intrusion alarm signal shall be transmitted to the ROC via the SCADA system. The alarm signal shall identify the zone in alarm on control consoles and CCTV observer consoles in ROC.
- c. The alarm signal shall cause the CCTV camera screen for the camera viewing the tunnel portal zone in alarm to be highlighted, or other Metro approved means of gaining ROC operators immediate attention.
- d. Intrusion warning signals within the tunnel zone in alarm shall be activated to flash alternately on-off at 1 second intervals (or other Metro approved means) to warn train drivers of an unauthorized entry into the tunnel. These signals shall be installed at both ends of every zone and strategically positioned to provide sufficient advance warning to approaching trains.
- e. Intrusion alarms, CCTV highlights, and train driver warning signals shall remain active until remotely reset by an operator at the ROC.

3. The subsystem shall be immune to EMI, RF emissions, and lightning.
4. The subsystem shall be capable of automatically generating both visual (through CCTV) and audible alarms to Personnel at ROC.
5. Local audible alarms with configurable automation timed resets shall be provided for intrusion detection for emergency exit hatches, cross passage doors, platform end gates and any other emergency access to dedicated right of way. An auxiliary intrusion contact shall also be provided for future interface of ProTran warning system by others.

## 9.14 FIRE ALARM SYSTEM

### 9.14.1 General

The fire alarm system shall generally consist of a fire control panel, smoke & heat detectors, monitor modules for water flow and valve tamper switches, monitor, relay, and control modules, and audible and visual notification devices.

If there is a fire, the fire alarm system shall provide alarm annunciation, and as applicable, automatic fan and damper shutdown, elevator recall and shunt trip, fire suppression activation, and evacuation by zone.

### 9.14.2 Design of the Fire Alarm System

- A. Fire alarms, supervisory alarms, and trouble alarms shall be monitored at the Fire Alarm Control Panel (FACP) in TC&C room and Central Supervisory Station in ROC through the CTS system.
- B. FACP shall provide dry contact summary alarm, summary trouble and summary supervisory interface to the SCADA PLC for system redundancy.
- C. At aerial and underground stations, the fire alarm system will also report to the Emergency Management Panel, where it will have a remote graphical annunciator with a graphical and tabular display which will guide first responders to the location of the alarm.
- D. There shall be two evacuation zones per station (at the underground and aerial stations) – an all evacuation zone, and an ancillary area only zone. The fire system will be programmed so that any one smoke or heat detector activation in the ancillary area will evacuate only the ancillary area. Any smoke detector in the public area will evacuate the entire station. Any two smoke or heat detectors anywhere in the station will evacuate the entire station. Any water flow alarm within the station will evacuate the entire station. Water flow or smoke detect alarms outside of the station will not evacuate the station.
- E. Underground stations shall have two deluge systems – one for each track. Activation of the deluge system shall cause the power on the affected track to be



- removed. This removal of power should occur in two ways – one through the deluge button being pushed, and one through the flow switch that senses the deluge water flow through the FACP.
- F. Underground and aerial station's TC&C rooms shall typically be protected by pre-action systems, which will be activated by a cross zone of smoke detectors and the activation of a low pressure switch.
  - G. Elevators shall be recalled through the FACP by activation of an elevator lobby smoke detector, or elevator equipment room detector. Alternate floor recall will be required as needed.
  - H. Elevator equipment rooms shall be shunt-tripped through the FACP by activation of a heat detector in the elevator equipment room (present code requires a heat detector within 18 inches of each sprinkler head). The AC power used to shunt trip the elevator room must also be monitored. In addition, when the room is shunt-tripped, the battery lowering device must be disabled (also through a control or relay module from the FACP).
  - I. Fans (except the Emergency fans) over 2000cfm shall shut down through the FACP, and fire smoke dampers shall close. In an underground station, a shutdown scheme should be designed so that a fire detector or a water flow switch in that area will shut down all fans and close all dampers in that area.
  - J. Fire detection throughout the system shall be accomplished via intelligent, addressable detectors. Addressable modules and/or supervised FACP remote I/O shall be provided to control and monitor the ventilation system and door releases. All fire initiated actions such as fan shutdown, elevator recall, shunt trip, door releases, etc. shall be implemented using addressable control modules. The FACP shall transmit alarm/trouble zones to the fire alarm workstation located in the ROC.
  - K. Fire system design shall minimize false alarms through the use of intelligent detectors, alarm verification, detector placement, and type of detector. Additionally, detectors in the public area and in cross passages should require carbon monoxide, infrared, smoke, and heat detection (or similar technology) to activate an alarm, in order to minimize the effects of false alarms on train movement and station evacuation or it may be possible to use a fully combined fire and gas alarm system, if such a system can be shown to meet Metro's needs, with the concurrence of Metro and the Authority Having Jurisdiction (AHJ).
  - L. In stations where a gas detection system is located, the fire alarm system may be used as the means of evacuating the station based on a high gas alarm (with AHJ approval). In this case, the notification devices must be marked "EVAC" and "Evacuation" instead of "FIRE". Coordination with the gas system design will be required.
  - M. Upon activation of the Evacuations microphone at the FACP or EMP, the FACP shall suppress all active fire audible devices in the notification appliance circuits (NAC).
  - N. Detection of a fire alarm condition by a system initiating device shall cause the following:

1. Indicate the device and its associated zone at the FACP and EMP.
2. ROC shall evaluate the alarm condition and select a pre-programmed scenario(s) developed and programmed. However, for rate-compensated heat detectors mounted on edgelight assembly of station platform shall automatically activate station emergency fans (exhaust mode) within 90 seconds.
3. Annunciate both visually and audibly at the FACP, EMP, and the Metro's fire alarm workstation in ROC.
4. Execute all automatic programs assigned to the alarm point per the sequence of operation.
5. Automatically shutdown fans and air conditioning equipment associated with the heat detectors, flow switches, smoke detectors, and duct detectors.
6. Automatically close combination fire/smoke dampers associated with duct smoke detection or local area smoke detection.
7. Automatically close fire held open doors associated with local area smoke detection.
8. Activate notification appliances.
9. Elevator fire recall/shunt trip (as applicable).

Additional design may be required to accommodate changes in code.

#### **9.14.3 Device Placement**

At minimum, the design shall comply with the code requirements and shall include additional provisions required by AHJ. Devices should be placed as follows, at a minimum. Additional devices may be required (or may be deleted) per AHJ.

- A. Smoke detectors:
  - TC&C rooms and buildings
  - TPSS rooms and buildings
  - Signal and radio bungalows
  - All ancillary rooms
  - Elevator lobbies
  - Cross passages
- B. Heat detectors:
  - High voltage areas (such as TPSS's and Auxiliary power rooms)
  - Elevator equipment rooms
  - Rate-compensated heat detector to be mounted onto edgelight assembly of the station platform for detecting fire on the train.
- C. Duct detectors shall be installed as required by code
- D. Audible and visual notification devices:
  - TC&C rooms and buildings
  - TPSS rooms and buildings
  - Signal and radio bungalows
  - Public areas in underground and aerial stations
  - All ancillary rooms
  - Stand alone TC&C, TPSS, and Signal buildings shall additionally have one strobe mounted outside the main entrance door.
- E. Remote graphical annunciation panel in EMP for monitoring and control of the FACP.

- F. Manual pull stations in standalone buildings:
- TC&C buildings
  - TPSS buildings
  - Signal and Radio bungalows
  - Yard buildings
- G. Manual pull stations in Underground and Aerial Stations - at the AHJ's discretion, manual pull stations shall be replaced by ETELS. The ETELS used for this purpose shall have fault reporting to the FACP. The ETELS may be installed in the following areas:
- Public areas
  - Areas of egress (emergency stairs, corridors, and hatches)

The number and placement of all devices shall be determined by code. All devices must be accessible per Metro Fall Protection Policy for maintenance, and shall not be installed directly over high voltage equipment. If a device cannot be accessed with an eight foot ladder, it must have a fall protection hook installed next to it or provide other means of access.

#### **9.14.4 Power**

Power supply and distribution for the fire alarm system shall be furnished in accordance with applicable NFPA Codes.

#### **9.14.5 Central Supervisory Station**

The Central Supervisory Station (CSS) shall be the primary means of annunciating, logging and managing fire alarms, trouble and supervisory information from the fire systems.

The CSS shall be implemented with two or more workstations, each capable of performing all of the required functions.

Alarm acknowledge shall only be required at one CSS workstation.

It shall be possible to partition CSS workstations for monitoring of selected territories.

The CSS shall be implemented using software listed to meet UL864.

Communications from FACP's to the CSS shall utilize Ethernet via a dedicated service in each SONET system and shall employ means and methods to satisfy UL864 requirements for Transmission and Communications Paths and/or approved by Metro and the AHJ.

### **9.15 GAS MONITORING AND SEISMIC ACTIVITY DETECTION**

#### **9.15.1 Gas Monitoring Equipment**

In areas classified as "gassy" or "potentially gassy" by CAL/OSHA or when directed by the Fire/Life Safety Committee, permanent gas monitoring equipment shall monitor hazardous gases in the atmosphere of subterranean facilities. Each gas monitoring

alarm shall be annunciated at Central Control and at the EMP in the station where the gases detected. Presence of an alarm shall initiate the appropriate Emergency Gas Operating Procedure (EGOP) which activates a pre-determined ventilation scenario to purge the gas. Unless otherwise directed by the Fire/Life Safety Committee, hazardous gases to be monitored shall be determined by review of subsurface conditions reports and other relevant data.

- A. The system shall initiate a minor alarm whenever methane is detected at 10% of lower explosion level (LEL), or hydrogen sulfide is detected at 5ppm. Low speed EGOP will be initiated automatically.
- B. The system shall annunciate a major alarm whenever methane is detected at 20% of LEL. High speed EGOP will be initiated automatically.
- C. The system shall annunciate an "evacuate" level alarm whenever methane is detected at 25% of LEL, or hydrogen sulfide is detected at 10ppm. High speed EGOP will be initiated automatically, and the station will be automatically evacuated.
- D. The gas system may have its own evacuation system (horns/strobes) or it can evacuate the station using the fire alarm system (with permission from the AHJ). In that case, coordination with the fire alarm design would be required or, it may be possible to use a fully combined fire and gas alarm system, if such a system can be shown to meet Metro's needs, with the concurrence of Metro and the AHJ.
- E. All alarms shall report to the EMP, both on a graphics display (showing exact location of the gas sensor in alarm) and by tabular alarm display.
- F. In addition, the current analog level of all gas sensors, trouble and calibration status shall show on the SCADA system at the ROC.
- G. All portions of the gas system shall be fully monitored by SCADA, and the system shall send trouble alarms additionally to the EMP.
- H. Gas monitoring equipment shall be accessible for maintenance. There shall be room for access with a ladder, and if a ladder over 8 feet is required, a fall protection hook must be installed next to the device or provide other means of access. Gas monitoring equipment shall not be installed over high voltage equipment.
- I. Gas control units shall not send gas level or limit alarms while in calibration mode. Calibration mode shall be indicated to SCADA and report a trouble to the FACP.

### **9.15.2 Seismic Detection Equipment**

Seismic switches shall be provided to advise of seismic event of sufficient intensity to cause potential damage to facilities. The devices shall be installed at intervals and locations to provide comprehensive coverage. The system shall report a self resetting minor alarm for events greater than 0.1G and less than 0.2G. The system shall report a latching major alarm for events greater than 0.2G.

The system shall be fully supervised and report alarm and trouble to the SCADA RTU.

## **9.16 CENTRAL CONTROL APPARATUS**

### **9.16.1 General**

Apparatus at central control includes console equipment to support various manned positions, recorders, printers, displays and special processing components.

Digital time clocks synchronized with a reliable, accurate time source shall be distributed throughout the facility.

An access control system and continuously recording CCTV/Video management system shall secure the entire facility perimeter and designated rooms. Proximity card reader access shall be provided.

### **9.16.2 Controller and CCTV Observer Consoles**

Train dispatcher consoles shall have powered sit-stand lifts to independently position the workspace and monitor surfaces.

Consoles shall be suitably arranged and include adequate surface area, communications capabilities, workstations, displays and other equipment, equipment cabinets, environmental conditioning, wire management and lighting as necessary to support the assigned supervision, control, communications and administrative functions in an ergonomic manner.

Communications equipment such as radio, public address, VMS, intercom, and telephone shall be integrated to the greatest extent that is possible while maintaining high availability and reliability requirements.

### **9.16.3 Voice Recording**

Multi-channel voice recording equipment shall be installed in the communications equipment room to provide continuous archival records of designated voice communications.

Recording channels shall typically include one channel for each radio voice channel, one channel for composite audio for each console operating position, and one channel for selected managers'/assistant managers' office phones. The individual composite console position channel shall record the position headset/handset audio and include all ATEL, ETEL, PTEL, MTEL, intercom, public address and radio circuit activity at the position.

### **9.16.4 Printers**

Color and black/white high volume printers shall be provided as necessary to support the rail operations and administrative functions. Sharing of printing resources shall be utilized to the greatest extent possible without compromising system security or performance requirements.

### **9.16.5 System Status Display Subsystem**

Large overhead flat panel displays shall be arranged throughout the control room to provide an overview summary status of rail operations and facilities. The displays shall permit each train dispatcher and management personnel to view the position and ID of

every train on the system, status of every switch, signal and track and summary alarm status of every subsystem. The position and arrangement of the status display shall permit comfortable viewing from each control console position.

#### **9.16.6 CCTV Wall Area**

A CCTV wall shall be provided in the CCTV observers' area to provide continuous viewing of all station platforms and designated high security areas. The wall shall be constructed as an arrangement of large flat panel displays of multiplexed live video.

#### **9.16.7 Data Processing Room**

- A. The data processing room shall house all data processing and data storage apparatus for central control, including computers associated peripherals, Metro telephone server, process controllers and other equipment requiring strictly-regulated temperature and humidity.
- B. Consoles shall be provided as necessary to support the following functions:
  - 1. Network monitoring and management
  - 2. System development and simulation
  - 3. Application monitoring
  - 4. All SCADA functions available to the rail operations control.
  - 5. Support Rail activation testing
- C. Each console position shall be provided with an ATEL.
- D. Designated console positions shall be provided with radio, public address/VMS capabilities.

#### **9.16.8 Communications Equipment Room**

The communications equipment room shall contain all ancillary central control equipment not requiring regular access for normal operations. The room shall be located adjacent to the data processing room.

Maintenance desks with convenience power outlets, ATEL and radio access shall be included and located as necessary to provide workspace and documentation storage as necessary for proper on-site maintenance of equipment.

MTEs shall be installed at each end of designated equipment racks.

#### **9.16.9 Battery Room**

The battery room shall contain provisions for housing batteries for communications battery/rectifier plant and UPS Module/battery system.

#### **9.16.10 Yard Control Tower Equipment**

Provide a train dispatcher console in the Yard Control Tower identical to the train dispatcher console at central control with the following services available:

- A. Yard operations radio channel.
- B. Emergency operations radio channel.
- C. Transmit amplifiers and receive amplifiers, if required, shall be provided in the Yard Control Tower communications equipment room.
- D. Supervision, base station disable, voting control, patching, and other radio facilities management control shall be performed by the communications controller at central control.
- E. Remote annunciator panel for the FACP.

## 9.17 YARD COMMUNICATIONS

### 9.17.1 *General*

The functionality of the various communications subsystems is described in other sections of this document. Only the specific application of subsystems to the Yard and its buildings is described in this subsection.

### 9.17.2 *Communications Equipment Room*

The Communications Equipment Room shall be located in the vehicle maintenance shop building. All terminal equipment for communication circuits to, from and within the Yard shall be installed at this location.

All communications Yard duct banks and Yard-to-mainline transitional communications duct banks shall terminate in a cable vault under or adjacent to the Communication Equipment Room and have at least 20% separate conduit capacity.

### 9.17.3 *Cable Transmission System (CTS)*

The fiber optic and CTS terminals for the Central Control/Yard backbone line shall be located in the Communications equipment room (reference Cable Transmission Systems Backbone System).

Local distribution throughout the Yard and associated buildings shall be by fiber optic and metallic cables as outlined in Cable Transmission Systems Backbone and Local Distribution - Metallic Pairs. Main feeder cables shall be provided to major buildings, e.g., Maintenance of Way, when they are present.

### 9.17.4 *Telephone Service*

All Yard telephone service (ATEL, ETEL and MTEL) shall be provided from the appropriate Yard Metro telephone system. Functionally, all services shall operate as described in the telephone system with the exception that ETEL circuits within the Yard complex shall ring to the Yard control room. Additionally, if the call is not answered after three rings, the call shall be automatically forwarded to the central control emergency reporting position.

### 9.17.5 *Public Address*

The Yard PA system shall be provided in accordance with Public Address System (PA). Primary paging zones in the yard shall be:

- Yard Track Area



- Vehicle Maintenance Shop
- Maintenance of Way
- All Call.

#### **9.17.6 SCADA**

The SCADA subsystem shall provide remote monitoring of Yard alarms at central control. Among the alarms to be monitored are:

- Selected traction power alarms
- Fire detection and suppression
- Selected communications subsystem alarms

In addition, operating parameters of selected Yard systems may be monitored and/or controlled at central control.

#### **9.17.7 Intrusion Detection**

All Intrusion detection in the Yard area shall be annunciated at central control.

#### **9.17.8 Fire Detection and Suppression Monitoring**

All fire detection and suppression monitoring devices in the Yard area shall be annunciated locally at the associated remote annunciator in the lobby, or other agreed upon point of entry, and remotely at central control and in the Yard control room. A map associated with the remote annunciator is required to show the yard and shops layout, with all the information necessary to find an annunciated alarm location.

All buildings within the yard should report to the yard and shops FACP. There should be a strobe on the outside of each building to guide the fire department to the location of the fire.

#### **9.17.9 Closed Circuit Television (CCTV)**

The CCTV system shall be compatible with the Metro CCTV system. It shall include 100% perimeter coverage, 100% parking lot coverage, and other cameras depending on design of the yard. Yard control should be able to either physically see, or see on CCTV, all train movement.

### **9.18 TRACTION POWER AND DISTRIBUTION SYSTEM**

#### **9.18.1 General**

The following criteria apply to the Traction Power and Distribution System that supplies power for the operation of the trains on Metro Rail Lines. Power to the trains shall be supplied at a nominal voltage of 750VDC provided by Traction Power Substations (TPSSs) located along the alignment of each line.

The TPSSs shall step down and rectify the high voltage 3-phase AC power received from the local Utilities to the nominal 750VDC required to run the trains. The positive polarity of the DC system shall be distributed to the trains from the TPSSs through feeder cables connected to a Third Rail for Heavy Rail Systems, or an Overhead Catenary System (OCS) for Light Rail Systems. Power from the Third Rail shall be transmitted to the vehicles through special collecting shoes installed on bottom part of the vehicles. Power from the OCS shall be transmitted

to the vehicles through pantographs installed on top of the vehicles. The negative polarity of the DC system shall follow a return path from the vehicle wheels along the running rails and back to the TPSS through negative return cables.

For underground stations and tunnel portals, the TPSSs shall also distribute high voltage 3-phase AC power to Auxiliary Transformers that shall provide 480VAC to a low voltage distribution system. When feasible and convenient, TPSSs shall also provide low voltage power to at-grade stations through auxiliary transformers.

### **9.18.2 Scope**

The following major components comprise the traction power and distribution system:

- A. Traction Power Substations-TPSSs
- B. Wayside Distribution System
  1. Feeder and Return Cables
  2. Third Rail
  3. OCS
  4. Running Rail
- C. Sectionalization and Emergency Trip System-ETS
- D. Trainway Feeder and Emergency Back-up Power Supply - EBPS

### **9.18.3 Codes and Standards**

The design of the Traction Power and Distribution System shall comply with the latest applicable requirements set forth by the following organizations, in addition to other applicable requirements not here listed:

- 
- National Fire Protection Association (NFPA)
- Electronics Industries Association (EIA)
- Cities and the counties in which the transit system will operate
- American National Standards Institute (ANSI)
- National Electrical Manufacturers Association (NEMA)
- Institute of Electrical and Electronics Engineers (IEEE)
- Insulated Cable Engineers Association (ICEA)
- California Public Utilities Commission (CPUC)
- California Occupational Safety and Health Administration (CAL-OSHA)
- California Electrical Safety Orders, Title 8
- American Society for Testing and Materials (ASTM)
- Underwriters Laboratories (UL)
- Uniform Building Codes (UBC)
- IEEE/APTA Rail Transit Standards
- National Electrical Code (NEC)

#### 9.18.4 Equipment Standardization

The design, major equipment, and components of similar TPSS and of the Wayside Distribution System shall be standardized and interchangeable between TPSSs and along the alignment of a line or construction segment. .

#### 9.18.5 Traction Power Substations

##### A. Locations, Capacities, and Other Requirements

1. The TPSS shall be sized and located along the alignment at suitable intervals based on computer simulation studies taking in consideration all the determining factors, such as track alignment, distribution system electrical parameters, vehicle propulsion, operational requirements, among others. Preferably, the TPSS shall be located at, or near, passenger stations to minimize voltage drops in the distribution system during train acceleration.
2. The TPSS shall provide 750VDC nominal voltage at 100% load and operate in a range from 500VDC to 950 VDC.
3. The TPSS locations, capacities, and all other characteristics shall be determined in order to meet the service requirements on the respective line, including vehicle loads, composition size, frequency of trains, and others, without degradation of service even with any one of the TPSSs out of service, providing a minimum voltage of 525VDC to any train at any location of the line.
4. The system shall be designed, and shall be tested, for the allowance of the simultaneous acceleration of two AW2 loaded full train compositions –one on each direction - at the substation from which the adjacent substations are furthest apart, under the following scenarios:
  - a. Acceleration of the two trains close to the selected substation while it is on service and the furthest apart substation is out-of-service;
  - b. Acceleration of the two trains to the selected substation while it is out-of-service and the two adjacent substations are on service.
  - c. The system shall assume line current limit or similar control mechanisms under reduced line voltage conditions, as specified by Metro Rail Fleet Services for each type of vehicle and in accordance with the assignment by Operations of the type(s) of vehicle(s) to operate on each specific line.
5. The negative to ground voltages shall be maintained below 50V - at any point of the line and at any time- during normal operation with all substations on service, and below 70V with any one substation out-of-service.

##### B. Utility Incoming Switchgear

1. Utility Incoming Metering Switchgear, as well as all incoming power connections, shall be provided in accordance with the specific Utility requirements. Adjacent substations shall be supplied from separate utility substations or from separate buses of the same utility substation, as practically possible. Isolation means shall be provided outside the TPSSs to enable the utility company to disconnect the high voltage incoming supply from the TPSS.

#### C. High Voltage Switchgear

High Voltage Switchgears shall receive power from the Utility Incoming Switchgear and distribute it to the individual Transformer-Rectifiers and, when applicable, to the various Auxiliary Transformers of the Stations. The 34.5 kV circuit breakers shall consist of SF6 insulated assemblies. Lower voltages circuit breakers may be of conventional vacuum type.

#### D. Transformer-Rectifier Units

1. Rectifier transformers shall be indoors, ventilated, dry-type, self-cooled, class AA, configured as required to power the rectifier units further described. The 34.5kV transformers shall be of cast coil construction. The lower voltage transformers may be conventional dry-type or cast-coil.
2. Rectifier Units shall be solid state diode, indoors, air cooled, and self-ventilated, configured for 12-phase operation (ANSI Circuit 31). Thyristors can be used in lieu of diodes, if technically and economically feasible and advantageous, with Metro approval. Each individual diode shall be provided with individual fuse protection. The rectifier shall maintain all its performance requirements even with one diode out of service per rectification leg.
3. Each Transformer-Rectifier Unit shall provide the following overload capacities:
  - a. 150% continuous overload for two hours, following continuous operation at 100% load with stabilized temperature.
  - b. 300% overload for five one-minute cycles equally spaced within the two hour overload period.
  - c. 450% overload for 15 seconds at the end of the two hour overload period.
4. Internal regulation shall be specified on a line specific base, from 4.5% to 6%, but shall be uniform throughout the same line.
5. All wiring inside rectifier cabinet associate with snubber circuits and diode fuses, shall not touch the diode heat sinks and the wire shall be rated for 2kV insulation.

#### E. DC Feeder Switchgear

1. DC Switchgears shall include all the feeder breakers to be connected to each individual section of the Third Rail and/or OCS.

2. DC Switchgears shall also contain isolation means from the Rectifier Units, consisting of one positive breaker and one negative no-load switch, mechanically interlocked to prevent in any circumstances a configuration in which the positive cathode breaker is closed or being closed while the negative switch is open or being opened.
  3. DC feeder circuit-breakers shall be single pole, extra high speed, including an internal mechanical over-current device, and with sufficient short-circuit capacity to interrupt the maximum short-circuit that may occur in the system.
- F. System Protection
1. Protective relays and other necessary devices shall be provided and individually set in accordance with a detailed and comprehensive protection coordination study, in order to assure effective, safe, and selective isolation of faults at any point in the system in any operational scenario.
  2. Each AC high voltage circuit breaker shall be provided with the instantaneous, inverse time, phase rotation, and under voltage relays.
  3. Each DC feeder breaker shall be provided with over-current and rate of rise relays. The rate of rise relays shall be capable of discriminating any low level short-circuit currents from any train operational currents at any time and any point of the line. The associated DC breaker shall trip for a low level short-circuit and not trip for a normal operational current.
  4. All rectifier transformers and rectifier units shall be provided with over-temperature protection.
  5. The DC feeders shall include Load Measuring Systems capable of testing the line for the presence of faults before allowing the closing of the associated feeder breakers. In the event of a trip of the respective breaker due to a short-circuit, three attempts will be made to re-close it. In the case that the three re-close attempts fail, the respective breaker will be locked out. Automatic re-closing shall not be allowed upon tripping of the respective breaker by any ground relay.
  6. The Rectifier Unit and the DC Distribution Switchgear shall be provided with DC ground protection of a high resistance type for the Heavy Rail TPSSs. The Rectifier Cubicle and the DC Distribution Switchgears will be insulated at 1,000 V level from the floor where they are installed and shall be respectively provided with separate individual ground relays. Ground faults on the Rectifier Unit shall trip the associated AC breaker, as well as the associated positive breaker. Ground faults on the DC Distribution Switchgear shall trip the respective AC breaker(s), positive breaker(s), and all its feeder breakers.
  7. The DC feeder circuit breakers of adjacent TPSS connected to the same OCS/Third Rail section shall be provided of a transfer trip system. Each breaker shall send transfer trip signal to the adjacent breaker whenever a fault is detected, including over-current, rate of rise, and ground faults. The over-current and rate of rise transfer trip signals shall allow the re-closure of the adjacent breaker, while the ground fault transfer trip signals

shall lock-out the adjacent breaker, without any re-closing attempt.

8. A Negative Ground Device shall be provided to automatically connect the negative bus of each substation to ground, in case the voltage to ground exceeds a pre-set value.
9. Surge Arrestors shall be provided on the load side of each DC feeder breaker, and shall be connected with insulated cables to grounding rods independent from the main substation rounding grid.
10. The positive breakers shall be provided with reverse current protection.
11. All Substations shall be provided with a grounding grid with a minimum of 5 ohms resistance to ground. The grounding grids shall also meet the requirements of the Utilities and provide safe step-and-touch potentials according to the applicable Codes and Standards. All non-current carrying structures and equipment enclosures shall be solidly connected to the grounding grid, except the DC Enclosures for the rectifiers and DC Switchgears, as required by their specific method of grounding – low resistance or high resistance.
12. The negative return of the Mainline and Yard traction power system shall not be grounded intentionally at any point, either at the substations, feeder cables, or at track level.
13. The Shops shall have separate and independent TPSSs solidly grounded and isolated from the Yards on the positive side by non-bridging section insulators, and on the negative side by Rail Insulated Joints, properly aligned with the respective section insulators.

#### G. Substation Operation

All TPSSs shall be designed for unattended operation and remote control by the Rail Operation Control-ROC. All circuit breakers shall be able to be both locally and remotely operated and a Local/Remote Switch shall be provided at each TPSS. Open/close commands and open/close indications shall be provided. All protective and supervisory devices shall be individually alarmed both locally and remotely. Voltage and current meters shall also be provided locally and/or remotely. A list of local and remote controls, indications, and alarms shall be for Metro approval for each specific TPSS design in order to provide its safe and reliable operation. The interface with the remote operation at ROC shall be coordinated with the respective SCADA system connected to the Rail Operations Control-ROC.

#### H. Auxiliary Equipment

##### 1. Lighting

Indoor lighting shall be provided by fluorescent fixtures. Design shall provide for minimum maintained lighting levels of 30 foot-candles vertical, average. Such lighting shall be located so as to illuminate satisfactorily the vertical surfaces of equipment such as switchgear and transformer rectifier units. Locations of lighting fixtures shall be coordinated to avoid interference with overhead raceways or other major wiring and shall not

be directly above switchgear, rectifiers, or transformers. Outdoor lighting shall be provided by energy efficient lamp fixtures with built-in photocell control. Design shall provide a minimum illumination level of one foot-candle at ground level. The general lighting shall be controlled from switches located near each access door.

## 2. Emergency Lighting

Substations shall be provided with emergency lighting from individual self-contained, maintenance-free units, with one or more lamps mounted on the equipment and a relaying device arranged to energize the lamps automatically on failure of AC power. Batteries shall have 1-1/2 hour minimum cut-off capacity from fully charged state and shall have testing means accessible from outside. Sufficient fixtures shall be provided to illuminate egress paths as required by code(s).

## 3. Convenience Outlets

Duplex convenience 20 amp outlets shall be located approximately 25 feet apart around the interior walls of the substations And within 10 feet of AC and DC protection relays (for testing equipment purposes).

## 4. Auxiliary Equipment

Other auxiliary equipment shall include, but not be restricted to, Batteries and UPSs for DC and AC control power and essential loads, AC and DC distribution panels, Local Panel Annunciators- LAPs, Smoke Detectors and Fire Control Panel-FCP, intrusion detection system, and provision for stray current corrosion measurements and/ negative return drain connections

## I. Construction and Equipment Arrangement

1. Underground Substation rooms or outdoor housing shall have adequate area to permit placement of electrical equipment and ancillary components of any manufacturer. Relative spacing and positioning of each equipment unit shall permit the removal, replacement, or maintenance of such unit without the necessity of moving other units. The arrangement of the equipment shall permit doors to be opened, panels to be removed, and switchgear and transformers to be withdrawn easily and conveniently.
2. In underground installations, ceiling heights and openings shall permit entry and removal of the largest components which will be installed in the room or housing.
3. Ventilation of substation rooms or housings shall maintain the interior temperature within limits suitable for full operation of all substations power equipment. Air conditioning may be used if demonstrated to be cost effective.
4. Sites for at-grade Substations shall be chosen taking in consideration the



proximity to Utility points of supply and environmental factors in relation to the area on installation.

### **9.18.6 Sectionalization, and Emergency Trip System-ETS**

#### **A. Sectionalization**

1. The Traction Power System shall provide means of isolating individual sections of the Third Rail and/or Overhead Contact System-OCS for maintenance purposes and/or for attendance to track incidents.
2. The line will be sectionalized, as a minimum, at each TPSS. The TPSSs will have four feeders, two feeders per line, each one providing power to one side of the TPSS, so that a track section between two TPSS will be dual powered by each one of the breakers of the two adjacent TPSSs.
3. All underground stations shall be sectionalized such that sectionalization occurs at the normal exit end of the station. For stations that don't have a TPSS, the normal end of the stations shall be sectionalized by Load Break Switches-LBSs.
4. As a minimum, sectionalization shall be provided at the departure end of all underground passenger stations through load-break switches or dc circuit breakers.

#### **B. Emergency Trip System-ETS**

An Emergency Trip System shall be provided for de-energization of specific sections of tracks under emergency situations, with the following requirements:

1. An ETS Blue Light Station-BLS shall be located at each tunnel at the ends of the platforms of underground stations; at the ends of platforms of elevated stations, as well as the ends of bridges along the alignment. A BLS per track shall also be located at each tunnel Portal.
2. The BLS locations shall not be accessible to patrons under normal conditions.
3. The ETS Blue Light Stations'-BLSs for underground stations and tunnel Portals shall remove power individually from the specific tunnel where they are located.
4. The ETS Blue Line Stations for aerial stations and bridges shall remove power simultaneously from the two respective tracks
5. An ETS BLS shall also be provided at each tunnel cross passage, one for each track, and shall remove power from the respective track.
6. An ETS-F (emergency trip) shall be located at each entrance of each at-grade TPSS. Each ETS-F will trip all the breakers internal to the TPSS both at High Voltage and DC voltage levels. In addition, it will trip the DC breakers of the adjacent TPSS that are connected at DC level with the TPSS in question.

7. Each BLS and ETS-F shall be provided with a mechanical padlockable lock out, which shall prevent the closing of the associated breakers. These breakers shall only be allowed to reclose once the local lock-out is removed and after a reset command given by ROC.

### **9.18.7 Trainway Feeder and Emergency Back-up Power Supply**

Note: The Criteria described on this section involve both the TPSSs High Voltage and the Station Low Voltage Systems. These two disciplines shall coordinate the Design in order provide a combined system that shall meet the Criteria here described

#### **A. Trainway Feeder**

1. Each TPSS providing power to underground stations shall have a separate and independent Incoming High Voltage Switchgear powered by a trainway feeder, in addition to the local Incoming High Voltage Switchgear directly powered by the utility. The trainway feeder shall consist of one set of High Voltage cables installed along the tunnels, and connected to all the involved TPSSs.
2. The trainway feeder shall be able to be powered from the incoming utilities of two different TPSSs. One of these TPSS shall provide power to the trainway feeder under normal operation, while the other one shall be available as a back-up.
3. The trainway feeder shall also be able to be powered by an Emergency Diesel Generator as part of the Emergency Back-up Power System – EBPS, described in the following section.
4. The three possible sources of power to the Trainway feeder – two different TPSSs and the Emergency Diesel Generator - shall be interlocked to assure that only one of them can be connected to the trainway feeder at any time. Such interlocking shall be hardwired with a fail-safe design. Fail-safe design means that in the occurrence of any relay malfunction and/or open circuit in any part of the interlocking circuits, the configuration of the system shall not be allowed to change.
5. Each underground station shall be able to have all of its loads fully powered by either its local incoming utility supply or by the trainway feeder.
6. Independent auxiliary transformers shall be connected separately to each one of the alternative power sources – local utility and trainway feeder.
7. Under normal operation, each one of these two power sources shall provide power to approximately half of the station loads as determined by the stations low voltage design.
8. In the event of loss of power provided by one of the two auxiliary transformers connected to the same loads, the system shall transfer the respective loads to the remaining transformer, through the closing of normally open tie breakers.
9. The operation of the tie breaker described in the previous paragraph shall be either manual or automatic, as chosen through a manual-automatic switch. The tie breakers shall be interlocked in such a way as to prevent the connection in parallel of two different auxiliary transformers at any

time. The automatic-manual switches shall be included in the interlocking and their operation at any time shall not allow the connection in parallel of the two transformers. This interlocking shall be hardwired and fail safe. Fail-safe means that upon the occurrence of any relay malfunction and/or open circuit in the interlocking circuitry, no change in the configuration of the breakers shall be allowed either in automatic or manual operation. The use of dual redundant PLCs for controls and interlocking of the system may be considered upon submission and approval by the Authority.

#### B. Emergency Back-up Power Supply - EBPS

1. The purpose of the Emergency Back-up Power System – EBPS, shall be to provide power to the ventilation fans required to maintain a minimum air flow throughout the underground facilities, as established on Section 8-Mechanical of these Criteria. The EBPS shall also provide power to all Facilities and Communications UPSs at each station. The EBPS shall be operated in case of complete loss of utility power on all TPSSs at each section of the line powered by one of the trainway feeders.
2. The EBPS shall supply power to the trainway feeder through a 480 VAC Diesel Generator and a step-up transformer to the trainway feeder voltage level.
3. The EBPS shall include the means of shedding all the loads that are not intended to remain in operation during its operation as above described.
4. The EBPS shall be activated through a sequence of operations performed remotely at the Rail Operation Control – ROC. A complete procedure describing all the controls sequence for implementation of the EBPS shall be provided, as well as the procedures to re-establish the system to its normal configuration.

#### 9.18.8 Wayside Distribution

##### A. DC Power Cables, Supports, and Ductwork

1. The traction power cables connecting the DC feeder breakers or wayside dc disconnect switches to the wayside distribution, and from the running rails to the negative bus shall be sized to accept maximum overload currents and a temperature rise not to exceed safe insulation design limits of the cables, based on a minimum insulation life of 40 years.
2. The cables shall have sufficient conductivity to maintain traction power voltage levels within the limits defined, confining the major voltage drop to wayside distribution system, rather than permitting excessive voltage drop in the connecting cables.
3. Traction power feeders for each power zone shall have cable capacity as required by the ratings of the associated DC feeder circuit breakers. These ampacities shall not be compromised by virtue of different types of raceway arrangements for various sections of the feeder.

4. Negative return cable shall be provided between the substation negative bus and the connection to each pair of running rails.
5. Since both the contact rail and the OCS constitute a vibrating mass, provision shall be made in the design of all cable terminations to prevent cable failures. The design shall utilize standard stranding feeder cables with a transition to extra-flexible stranding cables being provided for the final connection to the wayside distribution system.
6. Feeders shall be of a common conductor size, using multiple conductors for the different ampacities.
7. Cables shall be insulated, non-shielded, single conductors suitable for use in wet or dry locations and rated 2,000 Vdc, 90°C conductor temperature for normal operation. The conductors shall be copper with class C or D stranding, conforming to ASTM B8, with EPR insulation and low smoke jacket.
8. Cables from the substation to the OCS/contact rail shall not be spliced.
9. Traction power positive cables from the DC feeder breaker connections and negative cables from the negative bus connections shall be laid or run in appropriate raceways such as conduits, trays, cable trenches, or on racks through the substations. Such raceways shall provide an adequate cross-sectional area to permit a neat alignment of the cables and to avoid crossing or twisting single layer.

Positive and negative cables shall be run in separate raceways.

10. On racks, porcelain insulators designed for such purpose shall be used in the supporting arms. Such supporting arms or racks shall be spaced to avoid excessive weight or pressures against the cable insulation.
11. The ends of all exposed conduits shall be sealed.
12. All conduit stub-ups shall be protected against damage during construction operations.
13. Feeder ductwork shall be buried underground and shall consist of polyvinyl chloride (PVC) conduit encased in concrete. Design of ductwork such as conduit size, design cable pull, maximum total angular turn, and minimum embedment depth below grade, manhole spacing and duct gradient shall be in accordance with NEC requirements. Feeder ductwork shall be identified by a yellow warning tape 6 inches wide marked "Warning - High Voltage", laid 12 inches above concrete encasement in backfill.
14. Feeder ductwork shall be run as directly as practicable and shall be located to avoid interference with foundations, piping and other similar underground work. Risers consisting of PVC coated galvanized rigid steel conduit shall be provided at feeder connections to the wayside distribution.

## B. Contact Rail

1. The contact rail shall be bi-metallic. The two metal components of contact rail shall be forced to make permanent contact by applied pressures from bolts or equivalent methods, and interfacing surfaces shall be well cleaned to minimize electrical resistance between the metals. Contact surfaces shall be tightly sealed to prevent ingress of polluting or corroding matter.

The contact rail for the main line shall have an electrical resistance not greater than 0.002 ohms per thousand feet at 20°C, and shall be capable of carrying 4,000 amperes DC continuously at a temperature rise not exceeding 40°C over a 30°C ambient in still air.

The contact rail for the yard area shall have an electrical resistance not greater than 0.004 ohms per thousand feet at 20°C, and shall be capable of carrying 2,000 amperes DC continuously at a temperature rise not exceeding 40°C over a 30°C ambient in still air.

2. Contact rail height shall allow sliding of current collector shoes on top of contact rail when the contact rail is seated upon support. The top wearing surface of the contact rail shall be at least 2 inches wide to lessen wear.
3. The support insulator shall be centered below contact rail and the insulator base shall be sufficiently wide to provide a stable arrangement for the rail. The contact rail and support insulator shall withstand without permanent deformation the stresses caused by the maximum short circuit forces.
4. Contact rail joints shall not have misalignment or roughness. Bolted butt joints shall be ground smooth for minimum wear and abrasion of collector shoes.
5. Feeder connections to contact rail shall be suitably designed, located, and attached to provide permanent connection without excessive protrusion from the side of the rail.
6. The standard rail lengths shall be interconnected by means of bolted or welded joints.
7. The relative position of the contact rail to the running rails shall be coordinated with the design of the vehicle current collector.
8. The standard contact rail lengths shall not be less than 39 feet nor more than 60 feet plus or minus one percent. The rail shall have sufficient section modulus so that the maximum sag with a concentrated load of 30 pounds at midpoint between support insulators placed 10 feet apart shall not be more than 1/64 inch.
9. Protective cover shall consist of a curved insulating board covering the top of the contact rail. Side coverboard shall be provided where the contact rail is adjacent to safety or maintenance walkways in tunnel

sections. Protective covers shall have adequate clearance not to obstruct movement of current collector shoes and to permit insertion of shoe paddles.

10. The protective cover shall extend a minimum of 12 inches beyond the tip of the end approach.
11. Contact rail through stations shall be located at trackside opposite the platform.
12. Contact rail at-grade shall be located in the area between running tracks, except at the yard area, special trackwork and through center-platform stations.
13. Contact rail anchors shall be provided at maximum 2,000-foot intervals at midpoint between expansion joints. Spacing of anchors shall be adjusted to provide an anchor near the middle of curved sections, with expansion joints at points of tangent.
14. The contact rail shall be physically continuous between substations except at crosswalks and special trackwork locations where it is necessary to have separations in the contact rail. In addition, contact rail continuity shall be broken at wayside locations where further sectionalizing is needed to enhance operational flexibility. End approaches shall be provided at each separation to facilitate vehicle current collector shoe return to the contact rail without significant bounce.
15. The design of the entire contact rail system shall ensure that, during normal operation, at least one current collector shoe of a two-car train is always in contact with the rail.
16. The contact rail system shall be electrically continuous throughout the specific Metro Rail System. At crosswalk and special trackwork locations (or around expansion joints), electrical continuity shall be provided by jumper cables either bolted or welded to the contact rail. At substations electrical continuity shall be provided via DC switchgear, at wayside locations via motorized disconnect switches, connected to the contact rail by cables. The disconnect switches and cables shall provide conductivity that will not reduce the circuit capacity of the contact rail.
17. Contact rail sectionalizing at substations and at the locations of the wayside disconnect switches (as required to provide definite traction power zones) shall be implemented by means of non-bridgeable-type gaps. The length of the non-bridgeable gap between power zones shall be such that it cannot be bridged by the front and rear shoes of a transit vehicle. In the vicinity of passenger stations, each non-bridgeable gap shall be located preferably in the normally decelerating zone. At stations where it is more economical to locate a gap in the normally accelerating zone, and at gap locations other than at stations, the gap shall be of special design to prevent interruption of power to trains during normal operation.



## D. Overhead Contact System (OCS)

## 1. General

- a. The OCS includes the Catenary system, the physical support structure and the associated feeder system.
- b. The Catenary system consists of the conductors, including the contact wire and supporting messenger (where used); in-span fittings; jumpers; conductor terminations; and associated hardware located over the track and from which the vehicle draws power by means of physical contact between the pantograph and contact wire. The Catenary system shall provide for satisfactory current collection under all operating conditions. See Section 10 Operations.
- c. The physical support structure consists of foundations, poles, guys, insulators, brackets, cantilevers, and other assemblies and components required to support the Catenary system in the appropriate configuration. The support system shall support the Catenary system in accordance with allowable loading, deflection, and clearance requirements. The supports throughout the system shall incorporate double insulation in accordance with the requirements of CPUC General Order 95. Structure grounding and bonding measures shall be provided in accordance with corrosion control and safety requirements.
- d. The feeder system consists of the feeder conductors, jumpers; disconnect switches, ductwork, and associated hardware that feed the power to the Catenary system. The feeder system in combination with the Catenary system shall provide for the supply of traction power to the vehicles within the allowable voltage limits. The design for all feeders and jumpers shall be sized; based on their respective current carrying capabilities, the wires to which they are attached, and the power requirements of the system.
- e. Electrical continuity shall be provided in the OCS from substation to substation. At the substations, the Catenary system continuity shall be sectionalized to provide isolation of each electrical section. An arrangement providing continuity and flexibility for sectionalization of the OCS while any mainline or substation is undergoing repair or maintenance shall be incorporated. This will be accomplished through the application of both electrically and manually operated outdoor and indoor types of disconnect switches as required for operations and maintenance. Between substations the continuity shall be accomplished by insulated or un-insulated Catenary overlaps with continuous jumper arrangements, or section insulators with jumpers and disconnect switches and jumper arrangements.
- f. The design of the overhead contact system shall be based on technical, operation and maintenance requirements, aesthetics, and economic considerations, and shall be in accordance with the standards and criteria specified herein.



## 2. Codes and Standards

- a. In general, the OCS design shall be in accordance with the State of California Public Utilities Commission (CPUC) General Orders (class T circuitry, grade C construction), as more specifically set forth herein. In no case can exceptions be taken to the General Orders without the prior approval of the Authority and, ultimately, the CPUC.
- b. Additional codes and standards shall be applicable to specific aspects of the design as set forth herein.

## 3. System Description

### a. Subways

In subways and tunnels, a low profile Simple Catenary Fixed Termination (SCFT) or Conductor Rail system shall be used.

SCFT consists of a single contact wire and a messenger wire located over the track. The system shall be fixed termination, with the result that conductor tension will vary with temperature. The Catenary shall be supported by direct insulated attachment of the messenger wire to the subway or tunnel ceiling, with the contact wire registered by support arms. The limited clearance requires close support spacing to minimize system depth. System depth is defined as the vertical distance measured at each support location, between the messenger and contact wires.

The Conductor Rail consists of a contact wire clamped on the lower side of a box shape aluminum profile. The contact wire should be solid grooved copper 350 MCM per ASTM B47. At the transition from catenary system to the conductor rail system, a transition bar should be used to accommodate a smooth transition and absorb the vibrations of the incoming contact wire. At tunnel mouths or at locations where dropping water is expected, protection must be provided such as a protective plastic cover clipped on the conductor rail profile. A typical conductor rail system consists of Expansion joints, Fixpoint anchors, Endpoint anchors, Electrical connections, Section insulators, Clips for hooking standard earthing rods etc.

### b. At Grade Street Running

On the at-grade sections, a low profile Simple Catenary Auto-Tensioned (SCAT) shall be used, unless special considerations determine otherwise. The Catenary system shall consist of a messenger wire with a single contact wire supported by vertical hangers. The system shall be designed to meet capacity and power requirements without the use of supplementary along-track feeders. The system shall be auto-tensioned by means of weight-tensioning devices located at the termination points of the conductors. Tension in the conductors shall remain constant up to the conductor

temperature of 130° F, after which a resulting increase in temperature is to be accompanied by a decrease in tension. Tapered tubular galvanized steel poles shall be used.

c. At Grade – Dedicated Right-of-Way

On portions of alignment other than subway or downtown areas, a Simple Catenary Auto-Tensioned (SCAT) system shall be used. The Catenary system shall consist of a messenger wire with a single contact wire supported by vertical hangers. The system shall be designed to meet capacity and power requirements without the use of supplementary along-track feeders. The system shall be auto-tensioned by means of weight-tensioning devices located at the termination points of the conductors. Tension in the conductors shall remain constant up to the conductor temperature of 130° F, after which a resulting increase in temperature is to be accompanied by a decrease in tension.

d. Main Yard and Shops and Maintenance-of-Way Satellite Yards

In the yards and shops, a Single Wire Fixed Termination (SWFT) system shall be used. This consists of a single contact wire located over the track. The terminations of the contact wire shall be made directly to the poles with the result that conductor tension will vary with temperature.

The poles shall be tapered tubular steel, consistent with the rest of the system. Wherever practicable, eyebolt attachments to the exterior walls of the shops shall be used. Cross-span wires and backbone systems shall be used to minimize the number of poles where applicable.

4. Operations

The OCS shall be designed for vehicle operations with a design margin of 10 mph over the specified maximum vehicle operating speeds.

The OCS shall be designed for multiple pantograph operation with pantographs spaced in accordance with the specified train consists. The OCS shall be designed for operation of any type of Metro vehicle and take into consideration the use of pantographs both at one of the ends (trucks) of a vehicle or close to the midpoint of a vehicle, depending on their specific designs.

5. Sectionalization

a. In all systems, the Catenary shall be sectionalized by means of insulated overlaps wherever possible. In the event that an insulated overlap is not possible, mechanical section insulators shall be used. Mechanical section insulators shall be used at crossovers.

- b. In subways, where low-profile SCFT Catenary is used, the OCS shall be sectionalized by means of insulated overlaps. Mechanical section insulators shall be used at crossovers. If Conductor Rail is used, sectionalizing shall be by Mechanical section insulators.
  - c. The interfaces between the Main Line-Yard and Yard-Shops shall include insulated overlaps or non-bridgeable section insulators. The running rails at such interfaces shall be provided with insulating joints. On the interface Main Line – Yard, normally open disconnect switch shall be used on both the OCS and the running rails in order to allow the connection of the Main Line to the Yard.
  - d. Inside the shop building(s), the OCS Catenary shall be sectionalized at each entrance location to the building and at the center of the building, by mechanical section insulators. Each track shall have a manually operated switch for the feed to that Catenary. Where there are personnel gantries, there shall be an electrical interlock system that will not allow access while the Catenary is energized.
6. Span Lengths and Stagers
- a. The span lengths (spacing between contact wire registration points) and stagers shall be designed to provide for pantograph security (i.e., no pantograph dewirement) and to maintain good current collection and uniform wear of the pantograph carbon collector. Pantograph security is established by maintaining a minimum contact wire edge distance (from the tip of the pantograph) of 6 inches (3 inches at overlaps) under worst operating condition. In addition, the contact wire shall be staggered to provide for uniform pantograph wear.
  - b. The design shall consider the effects of environment, track geometry, vehicle and pantograph sway, and installation and maintenance tolerances. Vehicle roll into the wind shall be taken equal to 50% of the maximum dynamic roll value in accordance with AREA Manual, Committee recommendation, Bulletin 694.
  - c. The determination of span lengths for single wire systems shall take into consideration the requirements of Rule 74.4 of CPUC General Order 95 regarding broken OCS suspensions and fastenings.
7. Catenary Conductors
- a. The contact wire shall be solid grooved hard-drawn copper conforming to ASTM B47
  - b. The messenger wire shall be standard hard-drawn copper conforming to ASTM B189 with stranding conforming to ASTM B8, class B or higher.
  - c. Conductor tensions shall be in accordance with the requirements of CPUC General Order 95. Thirty percent cross-sectional area loss due

to wear of the contact wire and the effect of temperature change shall be taken into consideration in the design for conductor tension.

8. Contact Wire Heights

- a. Minimum contact wire heights shall be in accordance with the requirements of the CPUC General Orders 95.
- b. The contact wire height at supports shall take into consideration the minimum heights required by the various applicable codes and standards and installation tolerance (including track construction and maintenance tolerances).

9. Clearances

- a. Electrical clearances between the OCS and other facilities shall be in accordance with CPUC General Order 95.
- b. Mechanical clearances between the OCS and other facilities shall be in accordance with CPUC General Order 143A.
- c. For vehicle-related clearances full allowance shall be included for dynamic displacement of the vehicle under operating conditions (including track and other installation and maintenance tolerances).
- d. The following clearances shall be maintained between live conductors (including pantograph) and any grounded fixed structures in accordance with the AREA Manual (Chapter 33, Part 2) as follows:

	<u>Passing</u>	<u>Static</u>
Normal	4"	6"
Absolute Minimum	3"	5"

- e. Passing clearance is the clearance between the Catenary system or pantograph and an overhead structure during the short time it takes the power unit(s) of a train to pass.
- f. Static clearance is the clearance between the Catenary system when not subject to pantograph pressure, and the overhead structure.

10. Pantograph Clearance Envelope

A pantograph clearance envelope shall be developed for application on all tracks including superelevation, for worst case track conditions and full vehicle roll plus a 6 inch mechanical clearance. No equipment, except OCS steady arms attached to the contact wire, shall intrude into the pantograph clearance envelope.

11. Construction and Maintenance Tolerance

Design of the OCS shall be based upon a total construction-plus-maintenance tolerance for the lateral and vertical locations of the structures as follows:

<u>Location</u>	<u>Contact Wire</u>	
	<u>Lateral</u>	<u>Vertical</u>
Subways	± 1"	+0", -1"
Railroad Crossings	± 2"	+2", -0"
Overlap locations (Between wires)	parallel ± 1/2"	+1/2"
All others	± 2"	± 2"

Structures

Along-track spotting tolerance	
Special trackwork locations	= ± 2'- 6"
At other locations	= ± 5'- 0"
Cross-track spotting tolerance	
At restricted locations -13'- 0" track spacing	= ± 3/4"
At other locations	= ± 1 1/2"

12. Structure Design

OCS support structures shall be designed to carry the design loads according to the requirements of strength design and deflection design.

CPUC General Order 95 shall be used except where more stringent AISC and ACI requirements for steel and concrete design are applied.

a. Design Loads

OCS support structure design loads shall be the system self-weight plus the loads indicated in CPUC General Order 95, Light Loading.

Self-weight shall be the actual weights of poles, cantilevers, assemblies and conductors computed according to the AISC Manual of Steel Construction or obtained from manufacturer's catalogs, as applicable.

Wind loads shall be determined in accordance with CPUC General Order 95. According to this Order, a horizontal wind pressure of 8 pounds per square foot of projected area on cylindrical surfaces and 13 pounds per square foot on flat surfaces shall be assumed for all regions of California having an altitude of less than 3000 feet.

The design load shall be multiplied by the following overload factors to allow for uncertainties in loading conditions:

Design for strength = 1.1  
 Design for deflection = 1.0

b. Design for Strength

Steel poles, cantilevers and other structures shall be designed by the allowable stress method according to the AISC Specification for the Design, Fabrication and Erection of Structural Steel for Buildings (AISC S326).

Reinforced concrete drilled pier foundations shall be designed by the ultimate strength method according to the ACI Building Code Requirements for Reinforced Concrete (ACI 318); anchor bolts shall be designed by the alternate method (working stress method). The anchor bolts shall be designed based on ungrouted pole baseplate.

Laterally loaded pier foundations shall be proportioned according to the Texas Transportation Institute, Resistance of a Drilled Shaft Footing to Overturning Loads - (Research Reports 105-1, 2 and 3). A minimum factor of safety (to failure of soil) of 2.0 shall be used in the design.

For combined dead plus live (wind) loading the 33 percent increase in allowable stress specified by the AISC and ACI code shall be waived.

c. Design for Deflection

OCS support structures shall be designed so that structure deflections under service loads will not cause excessive movement of the contact wire. In addition, the steel pole shall be raked to compensate for the deflection generated by the self-weight and conductor tension loading.

Design of support structures shall be based on the following criteria for deflection and foundation rotation:

Structure	Loading	Maximum Deflection	Remarks
Steel Pole	Live (wind)	2 ½" @ contact wire level, including foundation rotation effect	Total deflection level including foundation effect shall be less than 4"
Foundation	Dead+Live	2.5% of pole height	
	Live (wind)	0.5% rotation	
	Dead+Alive	5.0% rotation	

d. Seismic Design

OCS support structures shall be designed to conform to the seismic design requirements of the UBC.

### 13. OCS Grounding and Bonding

- a. The OCS poles shall be properly grounded by grounding rods in accordance with NEC requirements. Ground resistance shall be a maximum of 25 ohms on regular poles and a maximum of 5 ohms on poles provided with surge arrestors.
- b. Within embedded track sections, negative rail grounding stations shall be provided at a minimum at all sectionalization locations.

## 9.19 Cyber Security for Rail Communication Networks/ Control Systems

### 9.19.1 Overview

This section summarizes the minimum requirements to secure control and network communications systems associated with Operationally Critical Zone (OCZ), Vital Interlocking Safety Zone (VISZ), and Fire Life Safety Security Zone (FLSZ) in Metro.

OCZ contains the centralized SCADA, train control, transit passenger information system and other centralized control hardware and software systems, and the equipment from these systems extending out to remote facilities such as train stations and trackside equipment.

VISZ contains any system that if 'hacked' and modified would cause an immediate threat to life or safety, for instance cause a collision or derail a train. For Example: Vital signaling which includes Interlocking, Automatic Train Protection (ATP), etc.

FLSZ contains any system whose primary function is to warn, protect or inform in an emergency. For Example: Emergency Management Panel, Emergency Ventilation systems, Fire Detection and Suppression systems, Access Control / Intrusion Detection Systems, Gas Detection Systems, etc. Compromise of FLSZ does not pose an immediate threat to life/property but can contribute to a higher loses in a multi-vector attack or unintentional environmental emergency.

The designer shall address cyber security throughout the lifecycle of the systems including but not limited to preliminary hazard analysis, architecture design, final design, procurement, installation, testing, commissioning and acceptance.

The designer shall follow the latest published American Public Transportation Association (APTA) recommended practices for "Securing Control and Communications Systems in Rail Transit Environments", National Institute of Standards and Technology (NIST) as well as the specific criteria identified in this section. All Metro Information Technology and Systems (ITS) policies, standards and guidelines must be adhered to by the designer.

### 9.19.2 Network Design

Network design shall utilize experts holding current manufacture certifications in Layer 2 switching; Layer 3 routing; Security; Voice; and Video and those experts shall be approved by Metro. The certification shall include CCNP, CCNP Security, CCDE and MCSE Desktop Infrastructure.



Network appliances shall be CISCO industrial rated products, made in the United States, except where the environment requires hardened equipment.

Train Control or life/safety networks shall be physically separated (air gapped) from other networks.

Subsystems shall each have separate services provisioned in the SONET system for interface to ROC. Virtual Local Area Network (VLAN) trunking through the SONET shall be prohibited.

Wireless local area network communications shall be prohibited except those encrypted technologies and applications as approved by Metro.

Any network switch, router or firewall that interfaces directly with the SONET shall be a managed device supporting:

- RADIUS authentication and accounting
- Port security
- SNMP traps for port security violations and general system exception conditions
- Local password authentication only when a RADIUS server cannot be contacted

Local functions shall continue to function when the head end SONET equipment is not functioning.

A local industrial hardened firewall appliance shall be provided for each RTU to prevent unauthorized outbound traffic and specifically control inbound traffic to only that which is necessary.

Networks for local communications shall not be trunked or otherwise transported across the SONET and shall not be accessible outside of the local subsystems.

The networks and their appliances shall be capable of and be configured to limit traffic only to that which is necessary and to only enable necessary features and functions. The configurations shall be documented.

The design shall use fixed IP addresses and routing unless otherwise approved by Metro. All management and networks with connectivity to the ROC shall use an IP allocation schema to be provided by Metro at time of design.

Network communications for vital train control or fire/life/safety critical functions shall utilize encryption and error checking equal or better than CRC16.

Dial up, Internet or other remote access capabilities outside of that which is required for system operation shall be prohibited.

Any room or case housing configurable controllers, PLC or RTU equipment shall utilize keyless access control and intrusion detection reporting to the access control system.

Any room, cabinet, or enclosure housing network appliances, manual override or local control capabilities shall alarm intrusion to the access control system and shall be in view of a fixed CCTV camera or the home position of a PTZ camera.

**9.19.3 Cyber / Network Security Configuration, Data and Documentation**

The designer shall provide a secure method for managing the network devices and changing addressing schemes.

The designer shall verify and provide documentation that the network configuration management interface is secured.

The designer shall provide access control lists (ACLs), port security address lists, and enhanced security for port mirroring.

The designer shall remove or disable unused network configuration and management functions on the network devices.

The designer shall provide firewall rules for inbound and outbound traffic based on deny-all rule sets.

The designer shall provide documentation on the network devices installed with security settings.

Documentation of applicable protocols, ports, services shall be provided including verification that connectivity, bandwidth, response time, and latency requirements are within subsystem operating requirements.

**9.19.4 Account / Password Management and Documentation**

Factory set default passwords shall be changed. Well known, anonymous and or guest accounts shall be disabled. Refer to the following ITS standards for details regarding account and password management: *MIT-03 Password Standard* and *MIT-13 IT Account Management Security and Administration*.

The designer shall document which accounts/roles are necessary, which are disabled, and all passwords. Procedures to change passwords shall be documented and provided to Metro upon substantial completion.

User authentication and authorization controls shall be transmitted in an encrypted manner.

Security Critical Systems shall provide for user accounts with configurable access permissions associated with user defined roles. At minimum the following roles shall be definable:

- User – Permissions are granted on the basis of least privileged access, legitimate functional business necessity, and with limits clearly defined.
- Administrator – Includes permissions for maintaining and configuring the application and operating system.

**9.19.5 Virus / Malware Protection**

All files and applications shall be checked for malware or other unauthorized modification prior to installation on equipment using software updated with the latest pattern and verification files.

**END OF SECTION**

## Appendix A

### REMOTE TERMINAL UNIT

#### PART 1 - GENERAL

##### 1.1 BACKGROUND

Los Angeles County Metropolitan Transportation Authority (Metro) remotely supervises and controls train operations and rail facilities from its Central Control Facility (CCF) with heavy reliance on Supervisory Control and Data Acquisition (SCADA) systems from various vendors. The SCADA systems interface with Remote Terminal Unit (RTU) equipment installed at wayside communications locations to provide interfaces to various subsystems including Train Control, Traction Power and station facilities.

The scope of work and specifications herein are specifically for the SCADA Remote Terminal Unit only.

##### 1.2 SCOPE OF WORK SUMMARY

###### A OVERVIEW

This contract will supply SCADA RTU assemblies in various configurations for installation in locations including but not limited to wayside equipment cases, communications rooms and traction power substations.

Actual assemblies to be supplied shall be based on a standard configuration with site specific main and remote I/O.

The Contractor shall assemble, factory test, package, store, ship, install and field test all assemblies.

###### B BASIS OF DESIGN

The standard RTU design described in these technical provisions shall be reliable and maintainable. The selected technologies shall be based on the latest stable product offerings and have verified vendor support for at least 20 years.

#### PART 2 - SCOPE OF WORK

##### 2.1 SCOPE OF WORK SUMMARY

A The work to be performed by the Contractor shall include procurement, assembly, configuration, documentation, storage, factory testing, delivery, installation, local field acceptance testing and maintenance training for Remote Terminal Units in accordance with the specifications herein. The Scope of Work shall include all components, subassemblies, equipment, materials, cable, cable management, hardware, software, configuration and appurtenances necessary to provide a complete operational Remote Terminal Unit as described in these Specifications. The Contractor shall furnish the system equipment, software and

## Appendix A

the management, labor, data, design, support services, parts, materials, tools, and incidentals necessary to complete the work in accordance with the specification requirements in a timely, proper, thorough, skillful, and professional manner.

### PART 3 - SYSTEM FUNCTIONAL REQUIREMENTS

#### 3.1 GENERAL RTU ARCHITECTURE

- A The RTU shall be an assembly of readily available components that are integrated together to provide telemetry and logic functions. The major components include: subpanel, assembly power supply and distribution; programmable logic controller, memory, input and outputs, input and output termination facilities; and equipment cabling, and mounting for installation in cases and enclosures.
- B The RTU shall be designed to accept a range of incoming power sources.
- C The RTU shall be constructed as a main assembly with the capability to add an additional expansion IO assembly.
- D The actual number and types of I/O modules shall be a site specific design responsibility of the Contractor including but not limited to:
- 32-point discrete input modules
  - 32-point discrete output modules
  - 8-point analog current/voltage analog input module
  - Remote I/O controller module
- E The following shall be the only actions necessary to add new modules (up to the design maximum):
- Install the new PLC I/O module and associated field interface module.
  - Install a PLC manufacturer prefabricated cable connection between the module and the field interface module.
  - Use the manufacturer provided PLC programming software to configure the new I/O.
- F Discrete input interfaces shall typically be dry contact inputs wetted by the assembly sensing voltage.
- G Discrete control outputs shall utilize high density PLC output modules to drive interposing relays on the assembly. Outputs shall be typically a dry contact

## Appendix A

closure. However the design shall accommodate fused wetted contacts where necessary.

### 3.2 ASSEMBLY

- A Components within assemblies shall be neatly arranged and fastened securely to the assembly subpanel with nonflammable fasteners. The use of plastic wire troughs shall be subject to review and approval. Metal wire clamps shall have insulating inserts between the clamps and the wiring. Wiring between stationary and movable components, such as wiring across door hinges or to components mounted on extension slides, shall allow full movement of the component without bending or chafing the wiring.
- B Each assembly shall include suitable signal and safety ground networks. The safety ground shall be isolated from the signal ground and shall connect to the ground (green) wire of the ac power input or to a dedicated ground wire for DC powered assemblies. The signal ground shall terminate at a separate stud connection, sized for connection of a lugged No. 2/0 AWG ground wire. Use of the enclosure frame, skins, or chassis mounting hardware for the ground network will not be considered acceptable. Assembly grounding shall be subject to approval.
- C The assembly shall have four distinct functional areas: power distribution, logic controller, auxiliary equipment and I/O.
- D Cables and wires shall be neatly arranged and secured/fastened to permit maintenance access to all equipment without the need to disturb any wire or cable.
- E Adequate space shall be allocated for routing and management of I/O module cable.
- F Space for routing and management of field interface cable shall be provided at each side of the I/O section. 2"x4" (width x depth) metal vertical cable management brackets shall be installed along each side of the I/O section for securing field cables of up to 1" diameter.
- G The auxiliary equipment area shall have a minimum dimension of 8"x16".
- H The I/O area shall include reserved space for installation of optional indicating fused feed thru terminal blocks for distribution of wetted contact control outputs. Space for at least 33 terminal blocks shall be provided.
- I The power distribution area shall include reserved space for mounting of an auxiliary power supply and fused load circuit terminal blocks. Incoming power terminal blocks shall have a spare line, neutral and ground terminal block reserved for installation of the auxiliary power supply.
- J All panel indicators shall be visible from the front of the assembly subpanel.

**Appendix A**

- K All assembly components, cables, and appurtenances shall be accessible from the front of the assembly.
- L Access to the rear of the assembly for any maintenance purpose shall not be required.
- M Provide an appropriately rated breaker for incoming power to serve as a main disconnect.
- N Provide a dedicated terminal block for distribution of incoming power, ground and neutral/return. The use of 120VAC power cords or plug-in transformers shall be prohibited. At least two spare circuits shall be provided.
- O Provide a dedicated terminal block for assembly 24VDC power distribution and return with one indicating fuse for each distribution circuit.
- P Power distribution shall utilize bus bars. No daisy chain wire distribution shall be permitted.
- Q Supply, return and ground shall use physically separated terminal block sections.
- R Provide approved vendor pre-manufactured I/O field interface module (IFM) terminal blocks for all field wiring or other terminal block assemblies. Each IFM or I/O terminal block shall be connected to its associated PLC I/O module using a vendor pre-manufactured cable.
- S All assembly wiring shall be secured with panel mounted guides and or other approved wire management devices.
- T All assembly components shall be professionally labeled in accordance with shop drawings using an approved manner.
- U Any terminal block section greater than 48VDC shall have a warning label.
- V Multi-conductor cables shall be used to interconnect the RTU discrete I/O terminal blocks to the Main Distribution Frame or board (herein referred to as the MDF). Dedicated blocks shall be assigned on the MDF for termination of RTU cables.
- W Each discrete I/O field cable between the RTU and the MDF shall be a minimum of 25-pair and shall be sufficiently rugged for direct routing in overhead cable trays.
- X All field interface connections shall terminate on the MDF. Outside/external cable shall terminate on building entrance protection blocks. Subsystem cables within the RTU communications room/cabinet shall terminate on regular interface blocks. Cross connect wire shall be used to interconnect each field interface to the SCADA interface terminal blocks on the distribution board/frame.



## Appendix A

### 3.3 REMOTE TERMINAL UNIT OPERATION

#### A Power-up and Initialization

1. Turning the RTU on or off shall be accomplished by operating a single breaker installed on the assembly. Operating this breaker shall control power to the entire assembly.
2. Upon application of power the RTU shall normally power up, initialize and achieve a normal operating state without the need for any manual intervention.
3. The RTU initialization shall clear all system fault registers before initiating the system diagnostics.

#### B Diagnostics

1. The RTU shall perform continuous diagnostics to report the following conditions:
  - a. CPU faults
  - b. Module faults
  - c. Remote I/O link status
  - d. Local serial link status for communications based subsystem interfaces
2. The RTU shall increment a health register (RTU Health Register) once per second to indicate to SCADA that the PLC is in a normal run mode and is executing the ladder logic. The register shall reset to zero when a value of 255 is reached.
3. The RTU shall monitor a health register that is updated by the SCADA system (SCADA Communications Watchdog). If the register fails to update for 30 seconds the RTU shall declare the SCADA system as offline. This status shall be reflected in the first contact of the first discrete output module. The contact shall be closed if SCADA is online and shall be open if SCADA is not online or the PLC is failed.
4. The RTU shall monitor control/wetting voltage in the 1<sup>st</sup> input point of the first discrete input module.
5. The RTU shall report a chassis summary blown fuse alarm for each fused terminal block starting at the 2<sup>nd</sup> input point of the first discrete input module.

#### C SCADA Communications

1. The Cable Transmission System (CTS) shall provide an Ethernet LAN dedicated for SCADA communications. The LAN shall allow all RTU to be accessed from a single port on the CCF SONET without the need for any

## Appendix A

external switching. The LAN shall also support RTU peer to peer communications without the need for any external switching.

2. The RTU shall include one Ethernet communications interface integrated directly into the PLC CPU for SCADA communications. It shall be possible to configure a default routing gateway for the interface.
3. The RTU shall include a master/slave serial communications port integrated directly into the PLC CPU for interface to diagnostic/programming software and external communications gateways.
4. In-rack technology shall be used wherever possible to implement local communications between the PLC and external subsystems that require serial interfaces.

### D Safety

1. The power-up initialization shall not unintentionally activate any control output.
2. Sufficient error checking and sparse encoding shall be inherent in the SCADA and remote I/O communications protocols such that it is improbable for normal environmental noise to unintentionally activate control output or incorrectly report the state of a discrete input.
3. Sufficient provisions shall be made in the RTU design and the design of its components such that it is improbable for normal environmental noise to unintentionally activate control output, incorrectly report the state of a discrete input, or corrupt a logic calculation.

### E Input/output SCADA Memory Mapping

1. A separate block of CPU memory shall be allocated for each of the following inputs and outputs:
  - a. Internal diagnostics and registers
  - b. Analog inputs
  - c. Analog outputs
  - d. Discrete inputs
  - e. Discrete outputs
  - f. Remote I/O
  - g. Gateway I/O
  - h. Special calculations
2. Control memory shall be cleared on PLC startup or reset prior to the enabling of any discrete output or serial protocol.

**Appendix A**

3. Chassis discrete input and analog input I/O shall be block transferred to the assigned memory maps on each CPU scan cycle.
4. Remote I/O shall be transferred to/from assigned memory maps on data change.
5. Gateway I/O shall be pushed/pulled by external gateway equipment provided to/from the assigned memory maps.
6. A block of memory of at least 20 words shall be reserved for special calculations. This area will store the results of any special calculations that must be performed on field I/O prior to transmission to/from SCADA.
7. The following diagram illustrates the minimum typical SCADA memory map allocations:

Appendix A

Table 1 - SCADA Memory Map

MAIN AND EXPANSION CHASSIS	STATUS REGISTERS	Internal and remote I/O status information	nn words of CPU status registers  RTU Health Register  SCADA Communications Watchdog
	DISCRETE INPUT	INPUT-MODULE1	32 bits
		INPUT-MODULE2	32 bits
		INPUT-MODULE3	32 bits
		INPUT-MODULE4	32 bits
	DISCRETE OUTPUT	OUTPUT-MODULE1	32 words
		OUTPUT-MODULE1	32 words
ANALOG INPUT	AINPUT-MODULE1	8 words	
REMOTE I/O - 1	DISCRETE INPUT	INPUT-MODULE1	32 bits
		INPUT-MODULE2	32 bits
		INPUT-MODULE3	32 bits
		INPUT-MODULE4	32 bits
	DISCRETE OUTPUT	OUTPUT-MODULE1	32 words
ANALOG INPUT	AINPUT-MODULE1	8 words	
REMOTE I/O - 2	DISCRETE INPUT	INPUT-MODULE1	32 bits
		INPUT-MODULE2	32 bits
		INPUT-MODULE3	32 bits
		INPUT-MODULE4	32 bits
	DISCRETE OUTPUT	OUTPUT-MODULE1	32 words
ANALOG INPUT	AINPUT-MODULE1	8 words	
GATEWAY INPUT			32 words
GATEWAY OUPUT			32 words
CALCULATIONS			20 words

F Discrete Control Processing

1. The RTU software shall allow each discrete output to act as either a momentary or maintained (latched) contact based on the value of its associated buffered control word.

**Appendix A**

2. Upon receiving a SCADA control word value of “0” the RTU shall take no action.
3. Upon receiving a SCADA control word value of “1”, the RTU shall set the control word to a value of “0”, and then activate the associated output relay for a momentary time period.
4. Upon receiving a SCADA control word value of “2” the RTU shall set the control word to a value of “0”, and then activate the associated output relay.
5. Upon receiving a SCADA control word value of “4” the RTU shall set the control word to a value of “0”, and then deactivate the associated output relay.
6. Receipt of any other SCADA control word value not listed above shall result in no action.
7. Momentary activation time shall be configurable in ladder logic for each individual control down to 250 milliseconds. The Contractor shall determine the value needed for each control output.

**G Remote I/O management**

1. The typical RTU program shall accommodate one expansion chassis and up to two remote I/O chassis with a typical configuration as defined in Table 1 - SCADA Memory Map.
2. Adding and enabling remote I/O shall only require the following actions:
  - a. Install a remote I/O communications module
  - b. Enable the I/O using the manufacturer provided PLC programming software to configure the remote I/O module and I/O and enable memory map transfer as a simple edit to the ladder logic
3. Once enabled, the RTU ladder logic shall monitor the status of the remote I/O link communications and redundancy and report it in the status register area of the SCADA memory map.

**3.4 SOFTWARE**

- A The Contractor shall provide a base ladder logic and application programming necessary to implement the functional requirements of the RTU as described in these technical provisions.
- B The software shall be designed for simple modification to implement site specific requirements.
- C The Contractor shall be responsible for configuration management of the base software throughout the warranty period and shall make and distribute revisions to address defects and change orders.

## Appendix A

- D The Contractor shall be responsible for the site specific programming for each RTU.

### 3.5 ACCESSORIES

- A The Contractor design shall accommodate the following accessories:
1. Auxiliary DC power supply and distribution terminal blocks
  2. 4-port Gateway communications server
  3. 10-port Gateway communications server
  4. HMI Panel
  5. Profibus DP-V0 slave
  6. MODBUS master/slave
  7. Fused control output terminal block

## PART 4 - SPECIFICATIONS

### 4.1 GENERAL

- A All parts used in fabrication and installation shall be new and carry original manufacturer warranty.
- B The system shall have a service life of at least twenty years.
- C Nothing in this document shall be construed or understood to authorize or direct the Contractor to deviate from any telecommunications industry standard, federal, state, or local safety laws, standard, and code.

### 4.2 RTU

- A RTU hardware and software shall support all functional requirements contained in these Technical Provisions.
- B Illuminated Panel Indications
1. Power available shall be indicated on each PLC CPU, PLC module, and power supply.
  2. Status point active shall be indicated for each discrete input point.
  3. Control point active shall be indicated for each discrete output point.
  4. Transmit and receive activity shall be indicated on each external data link and/or remote I/O processor.
  5. PLC CPU mode and status shall be indicated.

**Appendix A**

6. Fuse status shall be indicated in a consistent manner for each fuse except where otherwise approved.

**C Circuits****1. Main Incoming and Supply Circuits**

- a. A "main" breaker shall be installed to protect the main distribution terminals and to serve as a power disconnect.
- b. A fuse shall protect each power feeder circuit.
- c. The fuse shall be rated to protect the circuit wiring and permit full load of each distributed circuit.

**2. I/O Module Common voltage Supply Circuits**

- a. Common supply voltage shall be individually fused for each input and output module.
- b. Each fuse shall be an indicating type that is sufficiently rated to allow all inputs or outputs on a module to be active simultaneously and be rated lower than the main supply fuse so that a fault on a single point only affects a single module.

**3. Control Voltage**

- a. The power supply shall be 24VDC output, fully enclosed modular unit for panel or DIN rail mount. The PLC chassis power supply may be used for control voltage if the rating is sufficient to drive the maximum PLC chassis configuration and interface module relays for all indicating and control points in their active state.
- b. The power supply shall include automatic load current / short circuit protection.
- c. The voltage power supply output feeds shall include foldback circuitry such that after a fault is removed from the line the voltage level shall be automatically restored to its proper operating level.

**D RTU Modular Components (general)**

1. The RTU components shall be based on a family of processors that are compatible with the existing Metro SCADA system, having at least 10,000 units in service in North America, with local sales and service available within 50 miles of Los Angeles.
2. Module components shall be available from the RTU CPU vendor as well as certified third-party manufacturers to support a wide variety of input, output, and interfacing requirements.
3. Operating temperature 0-50 degrees Celsius with exception of modular communications equipment.



**Appendix A**

4. Communications equipment operating temperature 0-40 degrees Celsius.
5. Humidity 5-95% non-condensing
6. Noise immunity NEMA Standard ICS 2-230
7. Dielectric withstand 1500VDC (UL 508, CSA C22.2 No. 142)
8. Flammability and Electrical ignition UL94V-0
9. Removable barrier-type terminal blocks or connectors to allow module replacement without the need to disturb wiring
10. Self-locking tabs to permit installation and removal of chassis modules without the need for tools
11. Indexed plugs and connectors to prevent incorrect insertion
12. Continuous overload protection of 200V between any interface terminal and ground.

**E RTU CPU**

1. CPU memory shall be of adequate capacity to execute the Contractor provided firmware with at least 25% of the memory unused.
2. Typical scan time 0.9 ms/K
3. Supports online programming and editing
4. The CPU shall include one Ethernet port with a protocol supported by available OLE For Process Control (OPC) vendors.
5. The CPU shall include one master/slave serial port.
6. Local key switch mode selector for run, program, and remote modes.
7. System protection options shall be included for: program files, data tables, input/output forces, CPU run mode (requires insertion of a key).

**F SCADA Communications**

1. The RTU shall support Ethernet communications using a protocol compatible with the existing Metro SCADA system.
2. The SCADA communications shall be subject to approval.
3. The communications shall support efficient transfer of indication and control information.
4. It shall be possible (and be supported by OPC vendors) to pack discrete indications and controls into word based arrays and subsequently index specific bits out of each register word.

**Appendix A****G RTU Discrete Input Modules**

1. The RTU's contact input interface shall be capable of accepting isolated Form C contact inputs and be capable of interfacing to open collector inputs.
2. Filtering to limit effects of transients and contact bounce.
3. Optical isolation to shield logic circuits from possible damage due to transients.
4. LED indicator for each input point status.
5. Each module shall have 32 inputs.
6. The operating voltage range shall be at minimum 21-26 voltage DC.
7. Delay on-to-off and off-to-on time shall be 8ms.
8. Input impedance shall be at least 5KOhm.

**H RTU Discrete Output Modules**

1. RTU discrete output modules shall be identical across the system. Interposing relays shall be utilized where necessary to satisfy specific isolation and interfacing requirements.
2. Each module shall have 32 outputs.
3. Optical isolation shall separate module logic from field power.
4. The maximum off-to-on and on-to-off delay shall be 10ms.

**I RTU Analog Input Modules**

1. Each module shall support at least 8 differential or single ended inputs.
2. Inputs shall be user selectable to allow voltage or current signals, Voltage:  $\pm 10V$  dc, 0 to 10V dc, 0 to 5V dc, 1 to 5V dc, Current: 0 to 20 mA, 4 to 20 mA.
3. Full scale analog ranges: Voltage:  $\pm 10.5V$  dc, 0 to 10.5V dc, 0 to 5.25V dc, 0.5 to 5.25V dc; Current: 0 to 21 mA, 3.2 to 21 mA
4. Drift Voltage Terminal:  $\pm 0.003\%$  per  $^{\circ}C$ , Current Terminal:  $\pm 0.0045\%$  per  $^{\circ}C$ .
5. Current loop impedance  $\leq 250$  ohms.
6. Voltage input impedance  $\geq 220KOhm$ .
7. User configurable input filtering for desired noise suppression or signal response time.

### Appendix A

8. Input signals shall be isolated from the backplane.
9. The A/D converter shall provide a minimum precision of 4096 steps plus one sign bit.
10. Continuous automatic calibration.
11. Common mode rejection shall be at least 50db at 50 and 60Hz.
12. Isolation of 500VAC/VDC withstand for one minute.

#### 4.3 SUBPANEL

- A All materials used in the assembly including cable insulation or sheathing, wire troughs, terminal blocks, shall be made of flame retardant material and shall not produce toxic gasses under fire conditions (see NFPA 75). The use of PVC shall require approval. Each individual device shall be constructed so that by limiting combustible materials, or by use of enclosures, fire is not likely to spread beyond the device in which the source of ignition is located. Assemblies of floor standing equipment having external surfaces of combustible materials of such size that might contribute to the spread of an external fire shall have a flame spread rating of 50 or less (see NFPA 255, Method of Tests of Surface Burning Characteristics of Building Materials). (Note: UL listed equipment or equipment meeting the requirements of UL standard number 478 will be considered as meeting the above requirements.)
- B The subpanel shall be metal, finished on all sides to resist corrosion in a marine environment. The panel thickness shall be such that there is no deformation of the mounted subpanel while performing maintenance and assembly procedures. The panel material shall support drilling and taping of screws for installation of components and fasteners by others.
- C The maximum dimensions of the assembly including subpanel, all components, cables, bending radius and connectors shall require no more than 22" wide x 20" deep x 70" high for installation.
- D The assembly shall be suitable for mounting on a standard 19" telecommunications rack or plywood backboard.
- E Mounting and enclosure shall be site specific adhering to all environmental and other design criteria.

#### 4.4 CABLES WIRES

- A Each cable shall be labeled at both ends in a manner consistent with Contractor drawings.
- B Labels shall use non-fading, permanent marking, and can be read without disruption of any component.

**Appendix A**

- C Cross-connect wires shall be color-coded, twisted-pair, solid-core 22 AWG.
- D Polarity of cross-connect wires shall utilize a consistent color code scheme.
- E Solid and stranded conductors shall be of annealed copper wire in accordance with ASTM B33, Class B, and Class C stranded conductors conforming to ASTM B8, Table 2.
- F Conductors in multi-conductor cables shall be individually and uniquely color-coded.

**4.5 TERMINAL BLOCKS**

- A Terminal blocks shall be approved screw or spring clamp type.
- B Terminal blocks shall utilize full-depth insulating barriers or other approved methods to protect exposed conductive wire.
- C Terminal blocks shall accommodate up to two (2) 18 AWG wire for input and output signals.
- D All terminals and blocks shall be clearly labeled.
- E Ring-tongue, compression-type lugs with full length insulating sleeves shall be used for all screw-type terminal block wiring. No more than two wires shall be connected to any terminal.
- F Terminal blocks shall have finger safe terminals and bus bars for signals greater than 48V.
- G Line and supply terminal blocks shall be individually protected by replaceable fuses with visual and electrical indication of status.
- H Indicating fuse terminal blocks shall provide a single summary fuse indication signal.

**4.6 INTERFACE MODULES (IFM)**

- A All interface modules shall be vendor pre-manufactured, with removable field wiring terminal blocks.
- B Two terminals per point shall be provided for discrete IFMs.
- C One LED indicator lamp shall be provided per point for discrete IFMs.
- D Discrete output IFMs shall include one field replaceable relay per point with form-C contact rating of 6A.

**Appendix A**

- E Analog IFM shall allow separate configuration of each input for single-ended or differential voltage or current and provide shield grounding terminals. The Contractor may propose an alternative solution consisting of DIN mounted terminal devices with a connection to the analog input modules using a PLC vendor pre-manufactured cable.
- F The Contractor may propose an alternative higher density solution consisting of DIN rail mounted terminal blocks and plug in relays (for outputs) with a connection to the output modules using a PLC vendor pre-manufactured cable.

**4.7 ACCESSORIES**

- A Auxiliary DC Power Supply
  - 1. Phoenix Contact QUINT-PS-100-240AC/24DC/ 5 or approved equal.
  - 2. 24VDC @ 5 amp, DIN mount.
- B 4-Port Gateway communications server
  - 1. Fieldserver FS-B3510 or approved equal.
  - 2. 4 serial ports (2 RS323, 2 RS485)
  - 3. 2 Ethernet ports
  - 4. Supports a library of protocols including Allen Bradley DF1, MODBUS ASCII, MODBUS RTU, Hanning & Kahl HCS-V, Notifier FACP protocols, Safetran SCS128, Ansaldo/US&S Genisys, Allen Bradley Ethernet/IP, GE SRTP, MODBUS TCP, Telnet.
  - 5. 24VDC with less than 2 AMP power consumption.
- C 10-Port Gateway communications server
  - 1. Fieldserver FS-B4010-01 or approved equal.
  - 2. 10 serial ports (8 RS323, 2 RS485)
  - 3. 2 Ethernet ports
  - 4. ISA card slot for specialty communications modules supporting DH+, Profibus, DeviceNet, LonWorks, and ControlNet.
  - 5. Supports same library of serial/Ethernet protocols as listed for the 4-port communications gateway.
  - 6. 120VAC operation with less than 1.5A consumption.
- D PROFIBUS DP-V0 Communications Module
  - 1. In-chassis module compatible Profibus DP-V0 slave communications

**Appendix A**

2. Provide access to the Profibus Master input and output images with up to 244 bytes of Input and Output data, for a maximum of 400 bytes total.

**E MODBUS Master/Slave Communications Module**

1. In-chassis module compatible MODBUS master or slave communications.
2. One RS232 serial port, 110-38.4 Kbit/sec.
3. Two RS232/422/485 (configurable) serial ports 110-115 Kbit/sec.
4. RTU or ASCII mode.
5. Supports MODBUS functions 1, 2, 3, 4, 5, 6, 15, and 16.

**PART 5 - SUBMITTALS****5.1 SPECIFIC DOCUMENTATION REQUIREMENTS****A Operation and Maintenance Manual**

The Operation and Maintenance Manual is intended to serve as a system level operation and maintenance document for the RTU and its interfaces to external systems. The following shall be included:

1. System overview – block diagrams, system and component descriptions, theory of operation.
2. Manufacturer Data - The Contractor shall submit Manufacturers Data for each standard product delivered. The data shall include, where applicable:
  - a. Product description
  - b. Product specifications
  - c. Installation Guide
  - d. Users Guide
  - e. Diagnostics and Troubleshooting Guide
  - f. License
3. Drawings – Provide references to applicable Shop Drawings.
4. Maintenance and Operating Procedures - The Contractor shall supplement Manufacturers Documentation with step-by-step procedures for operating and maintaining the RTU system. The Contractor may provide specific references to provided Manufactures documentation to avoid unnecessary duplication of information wherever clarity of the procedure is not compromised. Procedures shall include but not be limited to:

## Appendix A

- a. Initiating Operating Modes: Procedure for properly starting, stopping the RTU as well as for entering and exiting any special modes of operation.
- b. Component removal and replacement: step-by-step procedures for physically removing and replacing components as well loading firmware and other site specific configuration steps. Procedures shall include precautions wherever applicable.
- c. Preventive and Periodic Maintenance (PM): Describe each manufacturer recommended PM and system PM procedure. Indicate recommended frequency.
- d. Troubleshooting and diagnostics: Provide a comprehensive troubleshooting guide using panel indicators and diagnostic tools to isolate and troubleshoot system problems including appropriate references to manufacture troubleshooting guides.

### B Shop Drawings

1. Drawings shall be provided for the following:
  - a. Functional system block diagrams showing Contractor provided equipment and the equipment with which it interfaces.
  - b. Enclosure assembly layout
  - c. Calculations
  - d. Detailed assembly drawings for mechanical and electrical fabrication of Contractor supplied assemblies and their connection terminations for interface equipment.
  - e. Parts List

### C Software Design

1. Documentation shall be provided for all Contractor developed PLC software and shall include:
  - a. Software block diagram – a block diagram overview of input/output/program memory maps, functions/algorithms, and data flow.
  - b. Overview – description of each major software component contained in the software block diagram.
  - c. Program details
    - (i) Start/end of each memory map area

## Appendix A

(ii) Detailed description of each custom algorithm or program segment (for example, input and output buffering, output pulse duration, PLC execution status, power up and fault routines)

d. Fully commented Source code

### D Training Documentation

1. Contractor supplied training documentation shall include components for instructor and students.
2. The level of instruction and detail in the documentation shall be sufficient to develop staff capable of operating and maintaining the RTU subsystem without the need for Contractor or vendor reliance.
3. The following training documentation shall be provided, each as a separate bound package:
  - a. Instructor Guide – The instructor guide shall provide a road map for instructors and shall follow industry best practices for technical instruction including but not limited to complete lesson plans and test materials.
  - b. Student Guide – Student guide shall contain summary lesson plans and appropriate reference material for effective classroom instruction.

### E Factory Test Plan and Procedures

Test plans and procedures shall be prepared in accordance with industry best practices and include but not be limited to:

1. Identification of test items.
2. System risk issues.
3. Features to be tested.
4. Features not to be tested.
5. Approach: roles and responsibilities, testing levels, configuration management/change control, and test tools, schedule requirements, planning risks and contingencies, and approvals.
6. Specific test procedures detailing test objectives, setup/tear-down, test steps, item pass/fail criteria, and test record documentation requirements.
7. Discrepancy reporting and corrective action.
8. Suspension and resumption criteria.
9. Test deliverables.

## PART 6 - EXECUTION



## Appendix A

### 6.1 TESTING AND ACCEPTANCE

#### A Factory Acceptance Test

1. RTU Factory Acceptance Test – Factory Acceptance Test shall verify that each unit is defect free and ready for shipment. All functional and specification requirements shall be verified including but not limited to:
  - a. Firmware execution
  - b. Communications interfaces
  - c. Each input from RTU terminal block to SCADA memory
  - d. Each output from SCADA memory to terminal block
2. Factory Acceptance Test Certification of Completion shall include:
  - a. Letter from the Contractor indicating that the equipment is ready to ship.
  - b. Signed test records for all tests.
  - c. Certification for each assembly may be transmitted separately should the Contractor choose a phased delivery.

#### B Local Field Acceptance Test

1. An installation test shall verify that each unit has been delivered free of damage and has been properly installed. Tests shall include but not limited to:
  - a. Proper mounting and securing of assemblies, racks and enclosures.
  - b. Power and safety ground connections
  - c. Power-up test
  - d. Wire pull test for all field wires
  - e. Each input from RTU terminal block to SCADA memory
2. A local interface test shall utilize RTU programming and diagnostic tools to verify that the RTU properly implements all of its required interfaces:
  - a. Each indication from device to RTU memory
  - b. Each control function from RTU memory to device
  - c. SCADA communications

### 6.2 TRAINING

**Appendix A**

1. Training shall be provided in two separate sessions.
2. One session shall be provided during the morning and one session shall be provided in the evening.
3. Each session shall include multi-media classroom instructions that include the use of a fully functional training RTU assembly, based on the typical RTU.
4. Each session shall be single course, with a maximum of 20 students, covering the following topics:
  - a. System overview – review system block diagram, describe each interface, and provide overview of the system functions and theory of operation.
  - b. PLC/RTU Assembly overview – describe each component of the PLC/RTU assembly, general functional description, specific function within the assembly, overview of wiring and cabling conventions.
  - c. System operating modes – Procedure for properly starting and stopping the RTU as well as for entering and exiting any special modes of operation.
  - d. External Interfaces – describe the operation of each RTU external interface.
  - e. Hardware maintenance – describe the proper procedure for inspecting, removing and replacing system components and performing preventive and periodic maintenance.
  - f. System programming and diagnostics – provide instruction on the use of supplied programming and diagnostics tools for upload/download of programs, out-of-box CPU and module configuration, monitoring PLC operation, forcing inputs and outputs and other recommended maintenance and diagnostic procedures.
  - g. Troubleshooting – using panel indicators and diagnostic tools to isolate and troubleshoot system problems. Review manufacture and Contractor supplied troubleshooting guides.

**PART 7 - DEFINITIONS AND ACRONYMS**

**7.1 ACRONYMS**

TERM	DEFINITION
AC	Alternating Current
AWG	American Wire Gauge
CCF	Metro Rail Central Control Facility
CIR	Communication Interface Rack
CPU	Central Processing Unit
CRC	Cyclical Redundancy Check

**Appendix A**

TERM	DEFINITION
DC	Direct current
DCB	Digital Channel Bank
DIN	Refers to a mounting rail solution. DIN is an acronym for Deutsche Institute fuer Normung, a German standardization body and member of ISO
IFM	Interface Module
I/O	Input and Output
METRO	Los Angeles County Metropolitan Transportation Authority
MTBF	Mean Time Between Failure
MTTR	Mean
OPCODE	Operation Code
PLC	Programmable Logic Controller
RTU	Remote Terminal Unit.
SCADA	Supervisory Control and Data Acquisition

**7.2 DEFINITIONS**

TERM	DEFINITION
DF1	Allen Bradley serial communications protocol.
Hazardous operating state	Any system state that may result in hazardous operating conditions.
Latent Defect	Defect in a product or service provided by the Contractor that is not discoverable by reasonable inspection and which causes service disruptions or harm.
Metro	Herein refers to the Los Angeles County Metropolitan Transportation Authority.
Mission Critical Function	A function that is relied upon for safe and efficient system operation.
Remote Terminal Unit	Wayside equipment that provides the central master station equipment with an interface to field indications and controls. The term "RTU" herein refers to Metro Red Line segment-1 type RTU's except where otherwise noted.

## Appendix B

### 1 SCADA RTU Interface Requirements

This section describes the interface requirements between the SCADA RTU subsystem and external equipment.

#### 1.1 General Interface Requirements

The SCADA RTU shall be the gateway for all indication and control interfaces to ROC. Data acquisition shall be implemented using a combination of in-rack I/O modules, distributed remote I/O and local subsystem communications links.

Interlocks shall be implemented in subsystem controls to prevent unsafe or destructive remote operation of equipment.

Interlocks shall be implemented in the field device control circuits and shall not be implemented in PLC logic except where approved by Metro.

#### 1.2 Discrete Indications

Each indication from external subsystems and equipment shall be in the form of an isolated dry contact rated at no less than 200VDC at 2 amperes.

One unshielded twisted wire pair between the subsystem control circuit and the SCADA PLC CIC or MDF shall be provided for each discrete indication.

The SCADA RTU shall provide 24VDC class-B wetting voltage current limited to 2 amperes on one wire in the pair and sense the return on the other wire. Indications shall function properly regardless of polarity; however, polarity shall be consistently wired system-wide.

Unless otherwise specified or approved by Metro, all indicating relays shall be normally de-energized.

Unless otherwise specified or approved by Metro, all indications shall utilize the relay normally open contact.

Unsupervised indication relays for fire life safety and security functions shall be normally energized.

#### 1.3 Discrete Controls

Unless otherwise specified or approved by Metro, all discrete controls shall be a momentary dry contact closures.

One unshielded wire pair shall be provided for each discrete control.

Control voltage shall be limited to 48VDC.

Subsystem control circuits shall implement any necessary interposing and seal-in (set) relays and reset relays so that a reset of the SCADA RTU does not affect the control state of field equipment.

## **Appendix B**

Interposing control relays shall include a commutating diode placed directly across the relay coil to extend the life of the SCADA control contacts. Relay modules with integrated commutating diode are preferred.

### **1.4 Serial Interfaces**

Unless otherwise specified or approved by Metro, all serial controls shall emulate control circuits seal-in (set) relays and reset relays.

Use of unpublished or proprietary protocols shall be prohibited.

Serial protocols shall be reliable conforming to the following requirements:

- Utilize error detection algorithms to prevent corrupt data from updating control or indication status.
- Implement polling, handshaking or session management to ensure the maintenance of accurate control and indication information under normal communications conditions.
- Implement link status monitoring and reporting.
- Report control and indication status changes within one second.

### **1.5 SCADA Communications**

SCADA communications protocol shall be compatible with the existing Metro SCADA systems and be approved by Metro.

### **1.6 Typical Controls and Indications**

The following sections describe the general requirements for SCADA indication and control. Additional control and indications shall be determined during design review based on the actual wayside equipment to be provided.

#### **1.6.1 General**

The SCADA interface shall include all control, status, trouble, alarm, lockout and control mode indications necessary for the safe, effective and efficient remote supervision and control of train operations, traction power and facilities.

Indications for each individual equipment and function shall be provided except if otherwise specified.

A SCADA Points Database shall be formally submitted (CDRL) to Metro as part of the Approved For Construction and AS-BUILT communications design package. A working set SCADA Points Database shall be provided to Metro as necessary to reflect the current working installation.

The SCADA Points Database shall contain the following information in a single EXCEL worksheet for every point in the SCADA interface:

- Point ID – The point ID shall be a unique alphanumeric identifier assigned by the designer. The Point ID shall remain fixed in every version of SCADA Points Database. There are no specific requirements for encoding of the identifier.
- Point description – Meaningful, functional description for the point. Identification of physical devices shall be consistent with the associated drawings including but not limited to Station Plans, Train Control, Traction Power, Overhead Contact System, and Facilities systems.

### Appendix B

- RTU ID – The RTU ID shall identify the RTU that contains the point.
- IO Location – The IO Location shall identify the physical location of the field wiring interface terminal cabinet.
- IO Type – The IO Type shall specify if the point is an indication or control.
- Point States – Point States shall provide information for encoding/decoding PLC register and bit values.
  - Define the meaning of each zero (0) and one (1) etc. for discrete values.
  - Conversion to engineering units for analog values
- RTU module assignment – RTU Module and point assignment.
- RTU module address – Register/bit assignment of the physical I/O
- Gateway address – Internal register/bit assignments for I/O interfaced through communications gateways.
- SCADA address – Register/bit assignment within the RTU for the SCADA interface. All I/O shall be buffered to internal RTU memory.
- RTU terminal – Terminal block and Terminal numbers for field cable termination within the RTU or remote I/O.
- SCADA MDF terminal – Terminal block and terminal numbers for field cable terminations within the main distribution frame or board.
- Field MDF terminal – Terminal block and terminal numbers for the device cable termination within the main distribution frame or board.

#### 1.6.1.1 SCADA Internal, Assembly and Remote I/O Diagnostics

- PLC health register counter (watchdog)
- CPU online indication (for redundant CPU systems)
- CPU available indication (for redundant CPU systems)
- Loss of module voltage alarm
- Loss of field control voltage alarm
- Summary fuse alarm
- Redundancy component failure alarm (one for each redundancy component)
- RIO link fail (for each RIO link)
- Data link fail (for each local data link)
- SCADA communications health register (watchdog)
- Sensing voltage fail alarm

#### 1.6.1.2 Train Control and Operations

- Track occupancy indication for each track circuit and overlay
- Traffic direction indication and request indication for each block at each end of interlocking and at each block section. Each direction shall be indicated as a separate point.
- Platform service mode control and indication for each terminal platform or turnback track.
- Switch normal and reverse position indication and control
- Switch lock indication
- Directional route locker indication for each interlocking route
- Individual signal clear indication and control for each signal
- Signal exit inhibit indication
- Signal exit inhibit request and cancel control

**Appendix B**

- Individual signal call-on for each signal
- Aspect indication for each signal
- Individual signal stop control for each signal. Signal stop shall cancel and established or requested route, fleet or call-on over the signal
- Time lock indication for each signal
- Signal system general alarm for each controller
- Interlocking routing mode indication and control
- Local control panel control mode indication
- Local control panel fail alarm
- Signal lamp out alarm
- Signal DC power fail alarm
- Signal ground fault alarm
- Train berthed indication for each turnback platform track
- Crossing gate up and down position indication for each gate
- Crossing call for each track at each crossing
- Crossing lights out alarm at each crossing
- Exit gate loop detector module fail alarm
- Signal bungalow intrusion alarm
- Signal bungalow smoke/heat detection alarm
- Signal bungalow fire panel trouble alarm
- TWC system trouble alarm

**1.6.1.3 Train to Wayside Communications**

- The entire indication memory for each loop shall be block transferred to the SCADA PLC.
- Available ROC TWC controls shall be assigned to a continuous block of TWC control memory and shall be block transferred from the SCADA PLC.

**1.6.1.4 Traction Power and Auxiliary Switchgear**

- Breaker/Switch open and closed indication
- Main and feeder AC breaker open and close control
- Main and feeder DC breaker open and close control
- Control mode, lockout, trip, trouble alarm for each remotely controllable device where applicable
- Utility under voltage alarm
- AC and DC bus under voltage alarm
- AC and DC switchgear control voltage alarm
- DC feeder load voltage energized indication (>25VDC)
- DC bus voltage energized indication (>25VDC)
- Emergency trip active alarm
- Emergency trip reset control
- Emergency Trip System pushbutton pressed and depressed indication (one for each button, including deluge)
- Emergency Trip System Trouble
- TPS Smoke/Heat alarm
- TPS Fire panel trouble alarm

## Appendix B

- TPS intrusion alarm
- TPS HVAC off/trouble alarm
- TPS high temperature alarm
- Lockout alarms
- Rectifier alarms
- Transformer alarms
- Diode alarms
- Any other I/O not mentioned above that is necessary for maintenance remote supervision/control, and efficient response.

### 1.6.1.5 Overhead and Rail Contact Systems

- Electrically and manually operated switch (EOS, MOS) open and closed indication
- EOS open and close control
- EOS control mode, lockout, trip, trouble alarm where applicable
- EOS emergency trip alarm
- EOS emergency trip reset

### 1.6.1.6 Auxiliary Power

- Main, feeder and tie breaker open and closed indication
- Automatic transfer switch position where applicable
- Main and feeder breaker open and close control
- Control mode, lockout, trip, and control power alarm for each remotely controllable device where applicable
- Ground fault and trouble alarms for each device where applicable
- Remote lockout reset controls were permitted by code
- Transformer trouble
- Feeder breaker load under voltage alarm
- Generator on indication
- Generator general trouble
- Generator fuel leak alarm
- Generator on and off control
- Load shed panel on utility indication
- Load shed panel shed and unshed utility control
- Load shed panel shed and unshed UPS control

### 1.6.1.7 Facilities and Emergency Management Functions

- EMP intrusion alarm
- EMP PC fail alarm
- EMP control mode indication
- Pre-programmed ventilation scenario selection and cancel

### 1.6.1.8 Station Communications Systems

- Camera power supply fail
- Digital video recorder trouble
- Fiber optic node major alarm
- Fiber optic node minor alarm
- Communications battery system trouble



**Appendix B**

- Public address primary amplifier fail alarm
- Public address standby amplifier fail alarm
- Public address speaker line fail alarm
- Public address control unit trouble alarm
- Public address supervisory alarms as required if used as part of a fire protection system
- Variable Message Sign power supply fail
- Emergency telephone line failure alarm

**1.6.1.9 Radio**

- Radio battery system trouble
- Uplink and downlink repeater fail
- Uplink and downlink repeater fail
- Test transceiver fail
- Amplifier fail
- Uplink and downlink repeater off indication
- Uplink and downlink repeater on and off control

**1.6.1.10 Facilities HVAC**

- Air conditioning unit trouble alarm
- Air condition unit on indication
- Air condition unit supply fan on indication
- Air condition unit air flow indication
- Air condition unit control mode indication
- Air condition unit disable and enable indication and control
- Supply fan fire shutdown indication
- Supply fan fire shutdown override indication
- Supply fan fire shutdown override control (maintained closed contact, fail open)
- Supply and exhaust fan on indication
- Supply and exhaust fan air flow indication
- Supply and exhaust fan control mode indication
- Dual supply fan lead/lag switch position
- Dual supply fan run enable and disable control
- Dual supply fan both fans failed alarm
- Supply and exhaust fan on and off control
- Fan high temperature alarm (where applicable)
- Fan filter alarm
- Tunnel high temperature (each bore at each end of station)
- Equipment room high temperature (where required)

**1.6.1.11 Facilities Access**

- Entrance grille open and closed indication
- Entrance grille operating indication
- Entrance grille open, close and stop control
- Entrance grille system trouble alarm
- Fare gate array system trouble alarm
- Fare gate array emergency release activate and cancel control

**Appendix B****1.6.1.12 Facilities Monitoring**

- Corrosion control system alarm
- Seismic detection minor (0.1G) alarm
- Seismic detection major (0.2G) alarm
- Seismic detection system trouble
- Sump/ejector pump panel alarm
- Sump/ejector pump tank service required alarm
- Sump/ejector pump running alarm
- Sump/ejector pump tank high level alarm
- Sump/ejector pump tank high level, overflow alarm
- Sump/ejector running with no flow alarm

**1.6.1.13 Uninterruptable power supply**

- General trouble
- Manual bypass alarm
- On battery alarm
- Low battery / imminent shutdown
- Hydrogen warning and explosive level alarm (where required)

**1.6.1.14 Emergency Ventilation and Booster Fan**

- Air flow indication for each direction and speed
- Supply on, motor control indication
- Exhaust on. Motor control indication
- High speed on, motor control indication
- Supply on, exhaust on, and standby control
- High speed on and off control
- Bearing trouble alarm
- Winding temperature alarm
- Vibration alarm
- Fan control mode indication
- Fan auto mode disable and enable indication
- Fan auto mode indication
- Fan and track damper supply or control power fail
- Fan and track damper open and closed indication
- Fan and track damper open and close control

**1.6.1.15 Under Platform and Overhead Exhaust Fan**

- Control mode indication
- Fan on indication (motor contactor)
- Air flow indication
- Fan on and off control

**1.6.1.16 Elevators**

- Position indication for each level
- Trouble indication
- Hall call indication for each level
- Lockout active indication

**Appendix B**

- Fire recall active indication
- Emergency mode indication
- Remote call control for each level
- Lockout activate and cancel control
- One-trip control

**1.6.1.17 Escalators**

- Running up indication
- Running down indication
- Key resettable trouble indication
- System trouble (non-resettable) indication

**1.6.1.18 Fire Detection**

All Stations:

- Fire system trouble
- Fire system alarm
- Fire supervisory (also summarizes ETEL trouble at FACP)
- ETEL trouble (one per ETEL via direct SCADA RTU interface)

Aerial Stations and Fire Protection where applicable:

- Pre-action tamper SW TC&C Rm. Supv.
- Flow xxx alarm (one per coverage zone)
- Fire xxx Alarm (one per room or coverage zone for smoke, heat, manual pull or flow detection)
- Manual pull xxx alarm (one per coverage zone in the public area)
- Tamper switch xxx Supv. (one per valve room location)
- Pre-action low pressure xxx Supv. (one per coverage area)
- Pre-action activation (one per system)

**1.6.1.19 Fire Suppression**

- Deluge active alarm
- Deluge release system trouble
- Water flow switch alarm
- Pre-action release alarm
- Fire pump supervisory alarm
- Fire pump system trouble

**1.6.1.20 Gas Detection**

- Probe gas minor level alarm
- Probe gas major level alarm (where required)
- Probe gas evacuation level alarm
- Probe gas reading indication
- Probe trouble or disconnected alarm
- Gas control unit trouble alarm
- Gas control unit in calibration alarm

**Appendix C**  
The Format for Radio Power Budget Analysis

Assumptions: The selected radiating coaxial cable's attenuation and coupling losses data are as follows:

Frequency Band	DB Attenuation / 100 Feet	DB Coupling Loss
160 MHz		
450-510 MHz		
800-860 MHz		

**1. Typical 450/500 MHZ RF Power Budget Calculations**

Case 1: VHF base station at passenger station A to portable radio in tunnel \_\_\_ft west of passenger station B.

Description	Gain	Loss
Base station output power		
Combiner (TC&C Room)		
Crossband Coupler (TC&C Room)		
Splitter (TC&C Room)		
Coaxial cables and connectors (TC&C Room)		
Radiating cable loss		
Directional tap at Station A		
Directional tap at Station B		
Crossband couplers in tunnels/stations		
Coupling loss		
Median body loss		
100% Probability Factor		
<b>Column total</b>		
<b>Subtotal</b>		
Signal level at receiver		
Signal required for ___ dB SINAD		
<b>Margin</b>		

**Appendix C**  
The Format for Radio Power Budget Analysis

2. Typical 450/500 MHZ RF Power Budget Calculations

Case 2: 450/500 MHZ base station or Off-air receiver to portable radios in the tunnels at Station B

Description	Gain	Loss
Base station/ Channelized Repeater Amplifier (CRA) output power		
Combiner (TC&C Room)		
Crossband Coupler (TC&C Room)		
Splitter (TC&C Room)		
Coaxial cables and connectors (TC&C Room)		
Radiating cable loss to point east of amplifier at _____		
Column total		
Subtotal		
Coupling loss		
Crossband couplers in tunnels/stations		
Median body loss		
100% Probability Factor		
Signal level at receiver		
Signal required for 18 dB SINAD		
Margin		
Carried forward from Subtotal		
Radiating cable loss to portable radio tunnel at _____ ft.		
Additional crossband couplers in tunnel and station		
Directional tap at _____		
Directional tap at _____		
CRA system gain at _____		
Coupling loss		
Median body loss		
95% Probability Factor		
Column total		
Subtotal		
Signal level at receiver		
Signal required for ___ dB SINAD		
Margin _____		

**Appendix C**  
The Format for Radio Power Budget Analysis

**3. Typical 800 MHz RF Power Budget Calculations**

Case 1: 800 MHz Off-air repeater at \_\_\_\_\_ to portable radios in the tunnel.

Description	Gain	Loss
ON-Frequency Repeater output power		
Combiner (TC&C Room)		
Crossband Coupler (TC&C Room)		
Coaxial cables and connectors (TC&C Room)		
Splitter (TC&C Room)		
Radiating cable loss to point east of 1 <sup>st</sup> amplifier at _____ (chainage _____ to _____)		
Column total		
Subtotal		
Coupling loss		
Median body loss		
95% Probability Factor		
Signal level at receiver		
Signal required for ___ dB SINAD		
Margin east of 1 <sup>st</sup> amplifier		

Case 2: (continued)

Description	Gain	Loss
Carried forward from Subtotal 1		
Additional radiating cable loss from 1 <sup>st</sup> amplifier to _____ (chainage _____ to _____)		
Crossband couplers loss		
CRA system gain at chainage _____		
Column total		
Subtotal		
Coupling loss		
Median body loss		
95% Probability Factor		
Signal level _____		
Signal required for ___ dB SINAD		
Margin _____		

**Appendix C**  
**The Format for Radio Power Budget Analysis**

Case 3: (continued)

Description	Gain	Loss
Carried forward from Subtotal 2		
Additional radiating cable loss from _____ (chainage _____ to _____)		
Crossband couplers		
CRA system gain at _____		
Column total		
Coupling loss		
Median body loss		
95% Probability Factor		
Signal level _____		
Signal required for ___ dB SINAD		
Margin _____		